

Bazénové žebříky	124	Pool ladders	124
Madla	128	Handrails	128
Bazénové žebříky, příslušenství	130	Pool ladders, accessories	130



Žebříky

jsou určeny pro privátní a komerční bazény. Jsou vyrobeny z leštěné nerez oceli AISI 304 (AISI 316) o průměru 43 mm. Stupně jsou doplněny protiskluz. nášlapy. Každý žebřík je zakončen opěrným kloubem směrem ke stěně bazénu. Kotvení se dodává s pouzdrem a svorkou pro uzemnění.



F87170020

Anoda pro žebřík
součástí balení
Anode for ladder
included

7012-5

Ladders

are designed for use in both private and public swimming pools. Ladders are made of glossy stainless steel AISI 304 (AISI 316) with diameter of 43 mm. Steps have anti slip parts from plastic. Every ladder is finished with a supporting joint to the pool wall. Ladders can be mounted on the pool edge via anchor socket or flange.

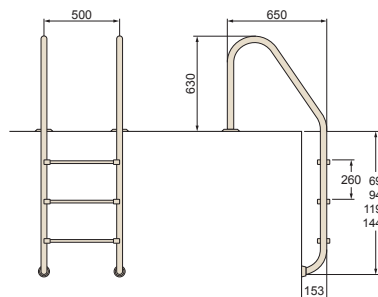







Technická data

- Protiskluzové nášlapy
- Kotvicí pouzdra
- + možno doplnit
- Dvojitý první stupeň
- Kotvicí příruby
- Opěrné klouby

Technical data

- Anti-slip steps
- Anchor sockets
- + available as spares
- Double first step
- Anchor flanges
- Supporting joints

Žebřík nerez Standard | Ladder stainless steel Standard

AISI 304 STAINLESS STEEL N. E. R. O. Z.	AISI 316 STAINLESS STEEL N. E. R. O. Z.			KG	cena Kč	cena Kč	€
7012	7312	B	Žebřík nerez Standard s pouzdrem 2 stupňový Ladder – stainless steel – Standard – with anchor socket 2 stairs		10,0	5 516,-	6 444,-
7013	7313	B	Žebřík nerez Standard s pouzdrem 3 stupňový Ladder – stainless steel – Standard – with anchor socket 3 stairs	 	11,5	6 021,-	8 062,-
7014	7314	B	Žebřík nerez Standard s pouzdrem 4 stupňový Ladder – stainless steel – Standard – with anchor socket 4 stairs	 	13,5	6 816,-	8 689,-
7015	7315	B	Žebřík nerez Standard s pouzdrem 5 stupňový Ladder – stainless steel – Standard – with anchor socket 5 stairs	 	15,0	7 936,-	9 338,-



F87170020

Anoda pro žebřík
součástí balení
Anode for ladder
included

7052-5

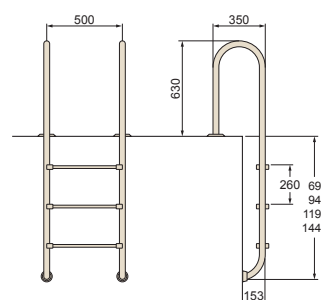







Technická data

- Protiskluzové nášlapy
- Kotvicí pouzdra
- + možno doplnit
- Dvojitý první stupeň
- Kotvicí příruby
- Opěrné klouby

Technical data

- Anti-slip steps
- Anchor sockets
- + available as spares
- Double first step
- Anchor flanges
- Supporting joints

Žebřík nerez Muro | Ladder stainless steel Muro

AISI 304 STAINLESS STEEL N. E. R. O. Z.	AISI 316 STAINLESS STEEL N. E. R. O. Z.			KG	cena Kč	cena Kč	€
7052	7352	B	Žebřík nerez Muro (Slim) s pouzdrem 2 stupňový Ladder – stainless steel – Muro (Slim) – with anchor socket 2 stairs		9,50	5 607,-	6 474,-
7053	7353	B	Žebřík nerez Muro (Slim) s pouzdrem 3 stupňový Ladder – stainless steel – Muro (Slim) – with anchor socket 3 stairs	 	10,5	6 062,-	6 830,-
7054	7354	B	Žebřík nerez Muro (Slim) s pouzdrem 4 stupňový Ladder – stainless steel – Muro (Slim) – with anchor socket 4 stairs	 	12,5	7 318,-	8 165,-
7055	7355	B	Žebřík nerez Muro (Slim) s pouzdrem 5 stupňový Ladder – stainless steel – Muro (Slim) – with anchor socket 5 stairs	 	14,0	8 081,-	9 342,-



F87170020

Anoda pro žebřík součástí balení
Anode for ladder included

7032-5

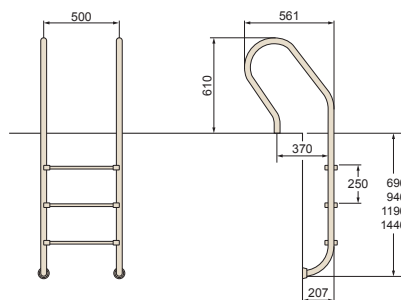
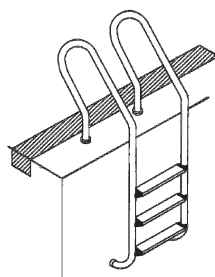

Technická data

- Protiskuzové nášlapy
- Kotvicí pouzdra + možno doplnit
- Dvojitý první stupeň
- Kotvicí příruby
- Opěrné klouby

Technical data

- Anti-slip steps
- Anchor sockets + available as spares
- Double first step
- Anchor flanges
- Supporting joints

Žebřík nerez Mixta Ladder stainless steel Mixta						KG	cena Kč	cena Kč	€
AISI 304 STAINLESS STEEL N. E. R. E. Z.	AISI 316 STAINLESS STEEL N. E. R. E. Z.						AISI 304 STAINLESS STEEL N. E. R. E. Z.	AISI 316 STAINLESS STEEL N. E. R. E. Z.	
7032	-	B	Žebřík nerez Mixta s pouzdrem 2 stupňový Ladder stainless steel Mixta with anchor socket 2 stairs		10,5	5 608,-	-		
7033	7333	B	Žebřík nerez Mixta s pouzdrem 3 stupňový Ladder stainless steel Mixta with anchor socket 3 stairs		11,0	6 543,-	7 260,-		
7034	7334	B	Žebřík nerez Mixta s pouzdrem 4 stupňový Ladder stainless steel Mixta with anchor socket 4 stairs		14,0	7 396,-	8 820,-		
7035	7335	B	Žebřík nerez Mixta s pouzdrem 5 stupňový Ladder stainless steel Mixta with anchor socket 5 stairs		15,5	7 914,-	10 752,-		

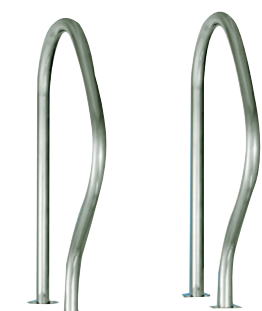

2x 7310 – strana 128



F87170020

Anoda pro žebřík a madlo součástí balení
Anode for ladder and handrail included



Spodní díl 739...

Dvoudílné bazénové žebříky jsou svojí konstrukcí určeny pro bazény, které jsou vybaveny rolovacím systémem pro krycí plachtu nebo krycí roletou apod.

Two parts pool ladders are constructed for swimming pools equipped with a surface covering system.

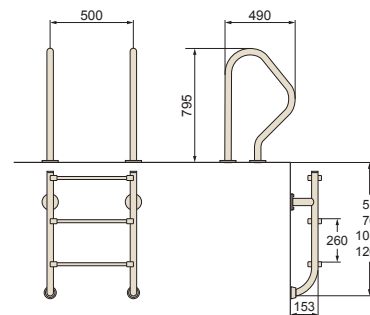

Technická data

- Protiskuzové nášlapy
- Kotvicí pouzdra + možno doplnit
- Dvojitý první stupeň
- Kotvicí příruby
- Opěrné klouby

Technical data

- Anti-slip steps
- Anchor sockets + available as spares
- Double first step
- Anchor flanges
- Supporting joints

Žebřík nerez dvoudílný Ladder stainless steel two-piece						KG	cena Kč	cena Kč	€
	AISI 316 STAINLESS STEEL N. E. R. E. Z.						AISI 316 STAINLESS STEEL N. E. R. E. Z.		
7310	B	Žebříkové madlo s přírubou – 1 ks Ladder handrail with flange – 1 pc		3,75			2 739,-		
73921	B	Spodní díl nerezového žebříku – 2 stupně (kotvení přírubou), AISI 316 Bottom part of stainless steel ladder – 2 stairs (flange), AISI 316		9,50			10 557,-		
73931	B	Spodní díl nerezového žebříku – 3 stupně (kotvení přírubou), AISI 316 Bottom part of stainless steel ladder – 3 stairs (flange), AISI 316		11,0			11 575,-		
73941	B	Spodní díl nerezového žebříku – 4 stupně (kotvení přírubou), AISI 316 Bottom part of stainless steel ladder – 4 stairs (flange), AISI 316		12,5			12 324,-		
73951	B	Spodní díl nerezového žebříku – 5 stupňů (kotvení přírubou), AISI 316 Bottom part of stainless steel ladder – 5 stairs (flange), AISI 316		14,0			13 073,-		

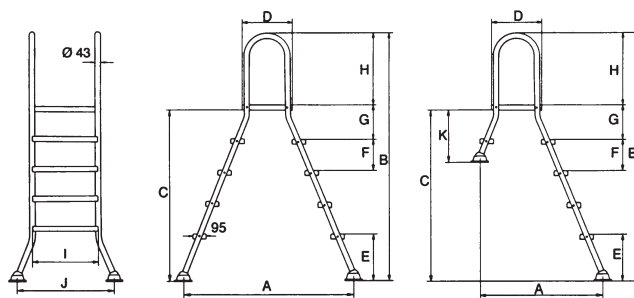

model	treads	platform	A	B	C	D	E	F	G	H	I	J	K
EEP-3	3 + 3	1	1 090	1 610	1 050	360	390	230	260	500	500	710	-
EEP-4	4 + 4	1	1 250	1 840	1 280	360	390	230	260	500	500	710	-
EEP-5	5 + 5	1	1 410	2 070	1 510	360	390	230	260	500	500	710	-
ESP-3	3 + 1	1	0890	1 610	1 050	360	390	230	260	500	500	710	480
ESP-4	4 + 1	1	0970	1 840	1 280	360	390	230	260	500	500	710	480
ESP-5	5 + 1	1	1 050	2 070	1 510	360	390	230	260	500	500	710	480

Žebřík nerez EEP | Ladder stainless steel EEP

				KG	cena Kč	cena Kč	€
AISI 304 STAINLESS STEEL NEREZ							
7083	B	Žebřík EEP pro nezapuštěné bazény – 3 + 3 stupně, pro bazény 1 m Stairs EEP for overground pools – 3 + 3 stairs, for pools higher than 1 m		20,0	10 208,-		
7084	B	Žebřík EEP pro nezapuštěné bazény – 4 + 4 stupně, pro bazény 1,2 m Stairs EEP for overground pools – 4 + 4 stairs, for pools higher than 1,2 m		21,5	10 998,-		
7085	B	Žebřík EEP pro nezapuštěné bazény – 5 + 5 stupňů, pro bazény 1,5 m Stairs EEP for overground pools – 5 + 5 stairs, for pools higher than 1,5 m		24,8	12 218,-		

Žebřík nerez ESP | Ladder stainless steel ESP

				KG	cena Kč	cena Kč	€
AISI 304 STAINLESS STEEL NEREZ							
7074	B	Žebřík ESP pro nezapuštěné bazény – 4 + 1 stupeň, pro bazény 1,2 m Stairs ESP for overground pools – 4 + 1 stairs, for pools higher than 1,2 m		18,7	9 833,-		
7075	B	Žebřík ESP pro nezapuštěné bazény – 5 + 1 stupeň, pro bazény 1,5 m Stairs ESP for overground pools – 5 + 1 stairs, for pools higher than 1,5 m		19,8	10 715,-		

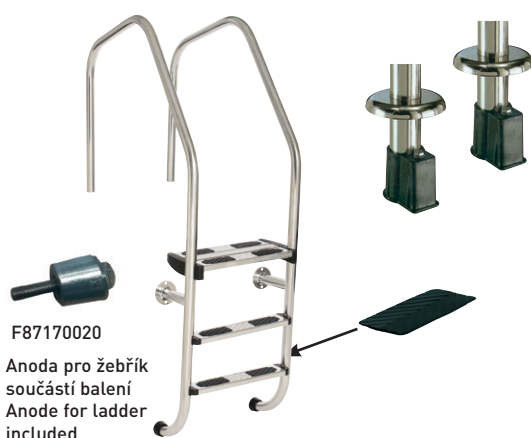

F87170020

Anoda pro žebřík
součástí balení
Anode for ladder
included

73221-5

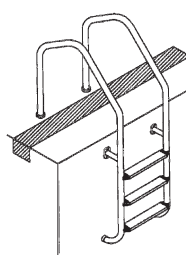

Technická data

- Protiskluzové nášlapy
- Kotvicí pouzdra
+ možno doplnit
- Dvojitý první stupeň
- Kotvicí příruby
- Opěrné klouby

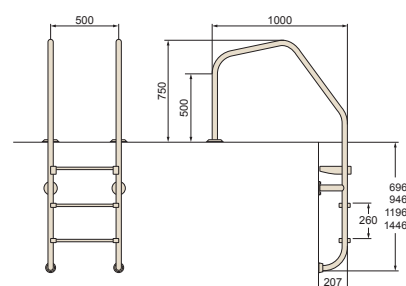

Technical data

- Anti-slip steps
- Anchor sockets
+ available as spares
- Double first step
- Anchor flanges
- Supporting joints

Žebřík nerez Munich | Ladder stainless steel Munich

				KG	cena Kč	cena Kč	€
AISI 316 STAINLESS STEEL NEREZ							
73231	B	Žebřík nerez série MUNICH s pouzdrem 3 stupňový pro komerční bazény s přelivem Ladder – st. steel – serie MUNICH with anchor socket 3 stairs for public pools with overflow		13,0	14 904,-		
73241	B	Žebřík nerez série MUNICH s pouzdrem 4 stupňový pro komerční bazény s přelivem Ladder – st. steel – serie MUNICH with anchor socket 4 stairs for public pools with overflow		15,0	16 018,-		
73251	B	Žebřík nerez série MUNICH s pouzdrem 5 stupňový pro komerční bazény s přelivem Ladder – st. steel – serie MUNICH with anchor socket 5 stairs for public pools with overflow		15,0	17 185,-		



F87170020

Anoda pro žebřík
součástí balení
Anode for ladder
included

Technická data

- Protiskluzové nášlapy
- Kotvicí pouzdra
+ možno doplnit
- Kotvicí příruby
- Opěrné klouby

Technical data

- Anti-slip steps
- Anchor sockets
+ available as spares
- Anchor flanges
- Supporting joints

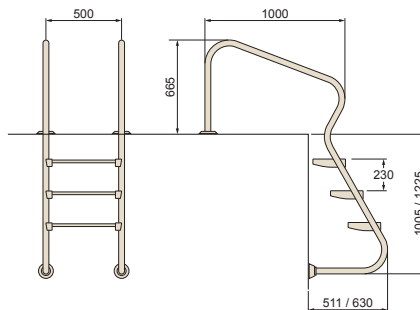

Žebřík nerez Ergo Ladder st. steel Ergo				KG	cena Kč	cena Kč	€
	AISI 316 STAINLESS STEEL N. R. R. E. Z.					AISI 316 STAINLESS STEEL N. R. R. E. Z.	
73113	B	Žebřík nerez Ergo s pouzdem 3 stupňový Ladder stainless steel Ergo with anchor socket 3 stairs		16,0		18 210,-	
73114	B	Žebřík nerez Ergo s pouzdem 4 stupňový Ladder stainless steel Ergo with anchor socket 4 stairs		18,0		24 983,-	



F87170020

Anoda pro žebřík
a madlo součástí balení
Anode for ladder and
handrail included

Žebřík nerez Ergo

Určeno pro bazény se zakrytím

Ladder stainless steel Ergo

Pool ladders constructed for swimming pools equipped with a surface covering system.

Technická data

- Protiskluzové nášlapy
- Kotvicí pouzdra
+ možno doplnit
- Kotvicí příruby
- Opěrné klouby

Technical data

- Anti-slip steps
- Anchor sockets
+ available as spares
- Anchor flanges
- Supporting joints

Žebřík nerez dvoudílný Ergo Ladder st. steel two-piece Ergo				KG	cena Kč	cena Kč	€
	AISI 316 STAINLESS STEEL N. R. R. E. Z.					AISI 316 STAINLESS STEEL N. R. R. E. Z.	
7310	B	Žebříkové madlo s přírubou – 1 ks Ladder handrail with flange – 1 pcs		3,75		2 739,-	
73913	B	Spodní díl nerezového žebříku ERGO – 3 stupně (kotvení přírubou) Bottom part of stainless steel ladder ERGO – 3 stairs, (flange)		18,0		20 005,-	
73914	B	Spodní díl nerezového žebříku ERGO – 4 stupně (kotvení přírubou) Bottom part of stainless steel ladder ERGO – 4 stairs, (flange)		18,0		26 525,-	



F87101606

Dvojitý stupeň lze namontovat na jakýkoli bazénový žebřík s kolmým madlem.

Double step can be used on any swimming pool ladder with vertical handrail.

Dvojitý stupeň Double step				KG	cena Kč	€
F87101606	B	Rozšířený (dvojitý) stupeň pro žebřík – NEREZ AISI 316 Double step for stairs – STAINLESS STEEL AISI 316		0,30		2 357,-



70BP1200, 70BP1500

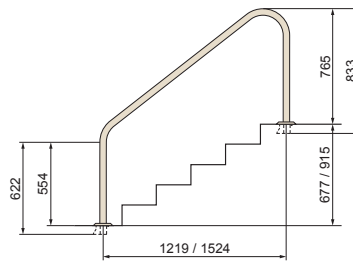

75BP1201, 75BP1501

AISI 316
 STAINLESS STEEL
 N. B. N. B. Z.

70BP1200, 70BP1500

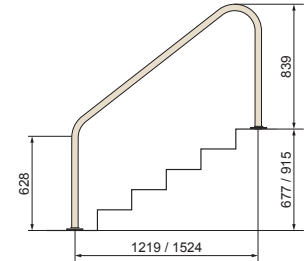

75BP1201, 75BP1501

Zábradlí | Handrail

			KG	cena Kč	€
70BP1200	B	Zábradlí ke schodům Handrail for staircase		8,20	4 616,-
70BP1500	B	Zábradlí ke schodům Handrail for staircase		9,10	4 771,-
75BP1201	B	Zábradlí s pevnou přírubou Handrail with flange		8,20	5 026,-
75BP1501	B	Zábradlí s pevnou přírubou Handrail with flange		9,10	5 934,-



7310

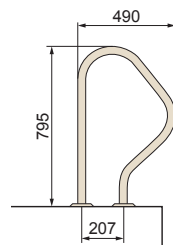

73011

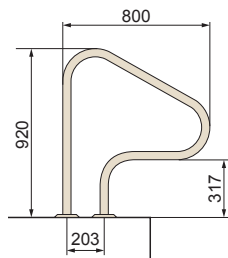

73013

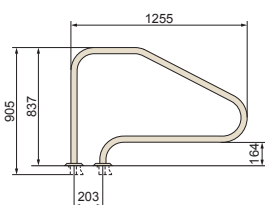

73014

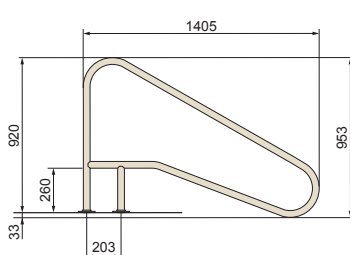

73012

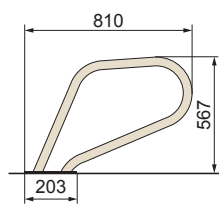
AISI 316
 STAINLESS STEEL
 N. B. N. B. Z.

Žebříkové madlo | Ladder handrail

			KG	cena Kč	€
7310	B	Žebříkové madlo s přírubou – 1 ks Ladder handrail with flange – 1 pc		3,75	2 739,-

 Anoda součástí
 Anode included

AISI 316
 STAINLESS STEEL
 N. B. N. B. Z.

Žebříkové madlo | Ladder handrail

			KG	cena Kč	€
73011	B	Žebříkové madlo s pouzdrum – 1 ks Ladder handrail with anchor – 1 pc		3,20	3 094,-

 Anoda součástí
 Anode included

AISI 316
 STAINLESS STEEL
 N. B. N. B. Z.

Žebříkové madlo | Ladder handrail

			KG	cena Kč	€
73013	B	Žebříkové madlo s pouzdrum – 1 ks Ladder handrail with anchor – 1 pc		4,60	4 033,-

 Anoda součástí
 Anode included

AISI 316
 STAINLESS STEEL
 N. B. N. B. Z.

Žebříkové madlo | Ladder handrail

			KG	cena Kč	€
73014	B	Žebříkové madlo s pouzdrum – 1 ks Ladder handrail with anchor – 1 pc		5,40	5 788,-

 Anoda součástí
 Anode included

Žebříkové madlo | Ladder handrail

			KG	cena Kč	€
73012	B	Žebříkové madlo s přírubou – 1 ks Ladder handrail with flange – 1 pc		7,50	4 933,-

 Anoda součástí
 Anode included



713005-20

AISI 316
STAINLESS STEEL
NEREZ

Madlo Handrail			KG	cena Kč	€
713005	B	Madlo 0,4 m (AISI 316) Handrail 0,4 m (AISI 316)	0,60	5 645,-	
713010	B	Madlo 1 m (AISI 316) Handrail 1 m (AISI 316)	1,20	8 017,-	
713015	B	Madlo 1,5 m (AISI 316) Handrail 1,5 m (AISI 316)	1,80	9 857,-	
713020	B	Madlo 2 m (AISI 316) Handrail 2 m (AISI 316)	2,40	13 313,-	



AISI 316
STAINLESS STEEL
NEREZ

Madlo Handrail			KG	cena Kč	€
713105	B	Madlo 0,5 m (AISI 316) Handrail 0,5 m (AISI 316)	0,60	3 443,-	
713110	B	Madlo 1 m (AISI 316) Handrail 1 m (AISI 316)	1,20	4 396,-	
713115	B	Madlo 1,5 m (AISI 316) Handrail 1,5 m (AISI 316)	1,80	4 849,-	
713120	B	Madlo 2 m (AISI 316) Handrail 2 m (AISI 316)	2,40	5 748,-	
713130	B	Madlo 3 m (AISI 316) Handrail 3 m (AISI 316)	3,60	7 117,-	



AISI 304
STAINLESS STEEL
NEREZ

713505

713501, 713504

713502P, 713504

713502L, 713504

VAGNER
POOL

Příslušenství Accessories			KG	cena Kč	€
713505	B	Nerez trubka pro zábradlí - Ø 35 mm, délka 0,5 m Stainless steel tube for staircase - Ø 35 mm, length 0,5 m	0,40	646,-	
713510	B	Nerez trubka pro zábradlí - Ø 35 mm, délka 1 m Stainless steel tube for staircase - Ø 35 mm, length 1 m	0,80	833,-	
713515	B	Nerez trubka pro zábradlí - Ø 35 mm, délka 1,5 m Stainless steel tube for staircase - Ø 35 mm, length 1,5 m	1,20	1 097,-	
713520	B	Nerez trubka pro zábradlí - Ø 35 mm, délka 2 m Stainless steel tube for staircase - Ø 35 mm, length 2 m	1,60	1 361,-	
713501	B	Nerez přírubové úchyty zábradlí - průběžný Stainless steel flange fittings for staircase - connecting piece	0,30	936,-	
713502P	B	Nerez přírubové úchyty zábradlí - koncový zaslepený pravý Stainless steel flange fittings for staircase - end blinder right	0,35	1 215,-	
713502L	B	Nerez přírubové úchyty zábradlí - koncový zaslepený levý Stainless steel flange fittings for staircase - end blinder left	0,35	1 215,-	
713504	B	Kotvení do betonu, nerez - pro úchyt zábradlí Anchoring for beton, stainless steel - for staircase fitting	0,15	718,-	
713000	B	Sada šroubů pro uchycení Set of screws for fixing		35,-	



Příslušenství Accessories		KG	cena Kč	€
70100	B Kotvení – plastové pouzdro – 1 ks Anchor plastic socket – 1 pc	0,30	87,-	
75100	B Kotvení – nerez příruba – 1 ks Anchor stainless steel flange – 1 pc	1,10	933,-	
751003	B Úchyt do betonu pro kotvení žebříku, nerez – 1 ks Fitting to concrete for anchoring ladders, stainless steel, 1 pc	0,10	1 217,-	
70101	B Sklápěcí kloub do pouzdra pro žebříky – 1 ks Tip-up joint in to socket for ladders, 1 pc	0,50	2 468,-	
70102	B Sklápěcí kloub s přírubou pro žebříky – 1 ks Tip-up joint with flange for ladders – 1 pc	1,50	2 216,-	
KRES050A	B Krytka kotvení (rozeta), nerez – 1 ks Cover of anchor, stainless steel – 1 pc	0,20	140,-	
KRES031A	B Opěrný kloub k žebříku – 1 ks Rubber joint – 1 pc	0,30	272,-	
7135022	B Sada pro fólii – 1 ks Kit for liner – 1 pc	0,40	1 388,-	
5121201	B Pospojení Titan – PUK 50 mm Earth connection Titan – PUK 50 mm	0,30	686,-	
5121202	B Pospojení Titan – PUK 63 mm Earth connection Titan – PUK 63 mm	0,35	934,-	
F87170020	B Anoda pro žebřík Anode for ladders	0,20	428,-	
F87170034	B Anoda pro madla Anode for handrails	0,20	715,-	



Fólie ALKORPLAN TOUCH Elegance