

Světla 84
 Světla VA 90
 Světla 93
 Bezpečnostní transformátory 96
 Světla Adagio Pro 98
 Světla MTS 99
 Příslušenství 100

Underwater lights 84
 Underwater lights VA 90
 Underwater lights 93
 Safety transformers 96
 Underwater lights Adagio Pro 98
 Underwater lights MTS 99
 Accessories 100

4





KIT pro instalaci světel – fóliové bazény

- Tento KIT je navržený pro použití pro různé druhy světel – přesněji tedy pro světla, která mají instalaci R 1½" Ext. závitem
- Lze použít jak pro fóliové/betonové bazény, tak pro bazény předvyrobené.

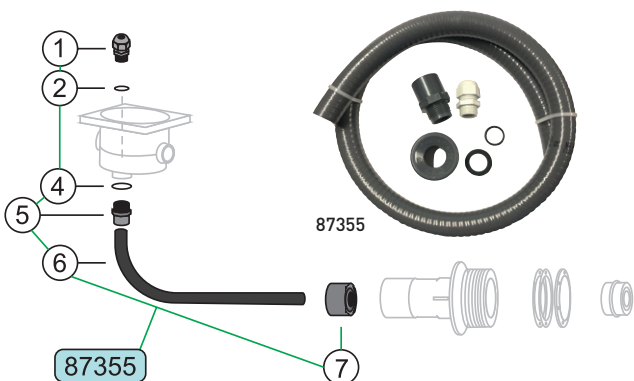

KIT pro instalaci světel – fóliové bazény

- The KIT is suitable for various types of lights - exactly for the lights with R 1 1/2" thread
- Can be used for both liner/concrete as well as for prefabricated pools

Číslo	Objednací kód	Název produktu
1	5209013	Průchodka PG 13,5 šedá
2	5191301903	Těsnění ploché (30 x 20 x 3)
3	873495V	Propojovací krabice VA
3	873495	Propojovací krabice HAYWARD-COFFIES
4	51901825	O-kroužek 18 x 2,5 mm na jímku a prům. klapku
5	02036025041	Přechodka 32-25 x ¾" Ext. upravená
6	0317643025	Bazénová hadice PVC 25 mm Ex
7	0225605025	Redukce krátká 50-25 mm



Sada propojovací hadice ke světlu | Set of connecting hose to the light

Objednací kód	Objednací kód	Objednací kód	Objednací kód	Objednací kód	Objednací kód	Objednací kód	Objednací kód	Objednací kód	Objednací kód
87355	B	Sada propojovací hadice ke světlu Connecting hose set for lights		1	0,50	cena Kč	297,-	€	

Instalace světla do trysky VA / VAMILA

- Pro světla s R 1½" Ext. závitem máme v nabídce speciálně upravené trysky VA a VAMILA
- V případě, že se rozhodnete pro instalaci světla do trysky VA, můžete vybírat ze 4 barevných variant:
Bílá ABS | Světle šedá | Tmavě šedá | Písková
- VAMILA základní prvek je určen pro předvyrobené bazény. Pro použití na fóliových bazénech je nutné dokoupit přírubovou sadu 3575.

Instalace světla do trysky VA / VAMILA

- For the lights with R 1 1/2" Ext. thread we have in our offer specially modified nozzles VA and VAMILA
- In case you choose for the installation light in the nozzle, you can choose from 4 colours: White ABS, Light Gray, Dark Gray, Sand
- VAMILA basic element is suitable to be used for prefabricated pools. To use VAMILA basic element for liner pools, it is necessary to buy flange set 3575.

Fóliové a předvyrobené bazény / Liner and prefabricated pools

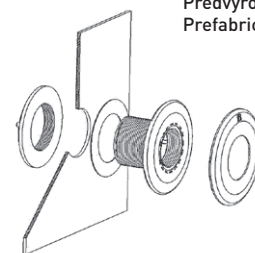
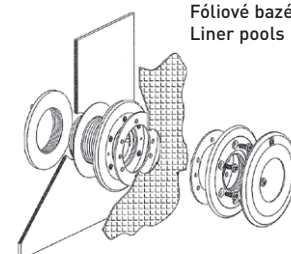
3131451
31314533131454
31314573131455
31314583131460
3131459Předvyrobené bazény
Prefabricated poolsFóliové bazény
Liner pools

Předvyrobené bazény / Prefabricated pools



85032

Pro základní prvek VAMILA
For basic element VAMILA

Liner	Prefabricated	Příslušenství Accessories		kg	cena Kč	cena Kč	€
3131453	3131451	B Tryska VA – stočená pro světla 1½" – bílá ABS Nozzle VA – for lights světla 1½" – white ABS		1	0,30	790,-	625,-
3131457	3131454	B Tryska VA – stočená pro světla 1½" – světle šedá Nozzle VA – for lights světla 1½" – light grey		1	0,30	869,-	687,-
3131458	3131455	B Tryska VA – stočená pro světla 1½" – tmavě šedá Nozzle VA – for lights světla 1½" – dark grey		1	0,30	869,-	687,-
3131459	3131460	B Tryska VA – stočená pro světla 1½" – písková Nozzle VA – for lights světla 1½" – sand		1	0,30	869,-	687,-
	85032	B Základní prvek VAMILA pro světla 1½" Basic element VAMILA for 1½" lights		1	0,30		1 729,-

Světlo SeaMAID MINI-Tube

- RGB; max. 320 lm, 9 LED, 8,2 W, 50 mm; 1,5" ext.
- Bílá; 630 lm, 18 LED, 6 W, 50 mm; 1,5" ext.
- Instalace do trysky
- Kužel světla 120°
- Kabel 2 m
- RGB – 11 statických barev a 5 programů

Light SeaMAID MINI-Tube

- RGB; max. 320 lm, 9 LED, 8,2 W, 50 mm; 1,5" ext.
- WHITE; 630 lm, 18 LED, 6 W, 50 mm; 1,5" ext.
- Installation in vacuum fitting
- Diffusion angle 120°
- Cable 2 m
- RGB – 11 static colors and 5 programs

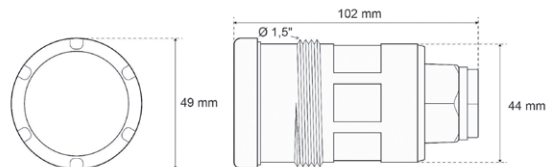

VALight

6500K
Studená bílá
6 W = 60 W

Světlo SeaMAID MINI-Tube Light SeaMAID MINI-Tube			KG	cena Kč	€	
81502778	B	Světlo SeaMAID MINI-Tube, 18 LED bílá, 6 W/12 V, 630 lm, 50 mm; 1,5" ext. Light SeaMAID MINI-Tube, 18 LED bílá, 6 W/12 V, 630 lm, 50 mm; 1,5" ext.	12	0,58	2 482,-	
81502785	B	Světlo SeaMAID MINI-Tube, 9 LED RGB, 8,2 W/12 V, 320 lm, 50 mm; 1,5" ext. Light SeaMAID MINI-Tube, 9 LED RGB, 8,2 W/12 V, 320 lm, 50 mm; 1,5" ext.	12	0,58	3 707,-	

		LED MINI TUBE	Nozzle colour					Type of pool			KG	cena Kč	€	
			White	RGB	White	Light grey	Dark grey	Sand	VAMILA					Liner
85133W	B	18 LED, 6 W, 630 lm	☐		○					✓		1	3 224,-	
85134W	B	18 LED, 6 W, 630 lm	☐			●				✓		1	3 546,-	
85135W	B	18 LED, 6 W, 630 lm	☐				●			✓		1	3 546,-	
85136W	B	18 LED, 6 W, 630 lm	☐				●			✓			3 546,-	
85133R	B	9 LED, 8,2 W, 320 lm		🌈	○					✓		1	4 424,-	
85134R	B	9 LED, 8,2 W, 320 lm		🌈		●				✓		1	4 867,-	
85135R	B	9 LED, 8,2 W, 320 lm		🌈			●			✓		1	4 867,-	
85136R	B	9 LED, 8,2 W, 320 lm		🌈			●			✓			4 867,-	
85033W	B	18 LED, 6 W, 630 lm	☐		○					✓		1	3 136,-	
85034W	B	18 LED, 6 W, 630 lm	☐			●				✓		1	3 450,-	
85035W	B	18 LED, 6 W, 630 lm	☐				●			✓		1	3 450,-	
85036W	B	18 LED, 6 W, 630 lm	☐				●			✓			3 450,-	
85033R	B	9 LED, 8,2 W, 320 lm		🌈	○					✓		1	4 337,-	
85034R	B	9 LED, 8,2 W, 320 lm		🌈		●				✓		1	4 771,-	
85035R	B	9 LED, 8,2 W, 320 lm		🌈			●			✓		1	4 771,-	
85036R	B	9 LED, 8,2 W, 320 lm		🌈			●			✓			4 771,-	
85032W	B	18 LED, 6 W, 630 lm	☐					AISI 316		✓		1	4 402,-	
85032R	B	9 LED, 8,2 W, 320 lm		🌈				AISI 316		✓		1	5 603,-	

Světlo SeaMAID LED Mini

- Polykarbonátové průhledné tělo
- Kabel 2 m v balení
- Instalace 1,5" ext. závit
- RGB – 11 statických barev a 5 programů



8550859



Light SeaMAID LED Mini

- Polycarbonate body
- 2 m cable included
- Installation 1,5" ext. thread
- RGB – 11 static colors and 5 programs

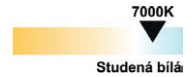
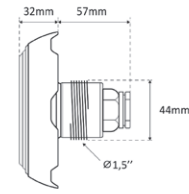
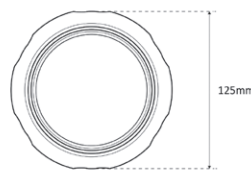

6 W = 60 W

Světlo SeaMAID | Light SeaMAID

					cena Kč	€
8550866	B	Světlo SeaMAID mini, 36 LED RGB, 7 W/12 V, 222 lm Light SeaMAID mini, 36 LED RGB, 7 W/12 V, 222 lm		1	0,60	2 482,-
8550859	B	Světlo SeaMAID mini, 12 LED bílé, 5,2 W/12 V, 540 lm, 7 500 K Light SeaMAID mini, 12 LED white, 5,2 W/12 V, 540 lm, 7 500 K		1	0,60	1 805,-

LED nerezové světlo CHIPLIGHT

- LED bazénové světlo
- Bílé

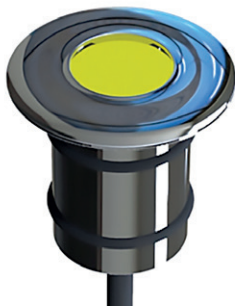

LED stainless steel underwater light CHIPLIGHT

- LED light for swimming pool
- White

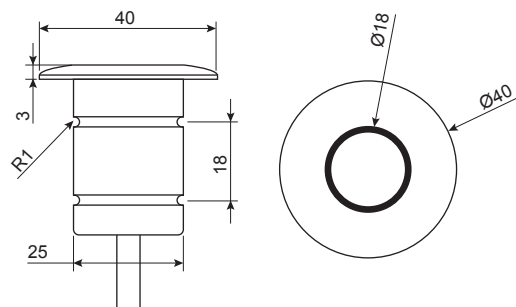

Nerezová LED žárovka CHIPLIGHT | Stainless steel LED bulb CHIPLIGHT

					cena Kč	€
81HTW021B	B	Nerezová LED žárovka CHIPLIGHT – LED Bílé, 2 W/12 V, 2 700 K Stainless steel LED bulb CHIPLIGHT – LED White, 2 W/12 V, 2 700 K				1 276,-

Mini světlo LED Zodiac

- 9 statických barev
- 5 přednastavených barevných schémat
- Změna barvy:
Manuálně: ON/OFF
Vzdáleně (připojení k Exo® iQ R)
- Délka kabelu: 3 m



Mini light LED Zodiac

- 9 fixed colors
- 5 preset color schemes
- Change of color:
Manual: ON/OFF
Remotely: (connection to Exo® iQ R)
- Cable length: 3 m

Bílá a šedá krytka součástí balení
White and grey front cover included

Mini světlo LED Zodiac | Underwater loudspeaker

					cena Kč	€
8WT000233	D	Světlo ZODIAC RGBW, 6 W, 160 lm – 1,5" ext. Light ZODIAC RGBW 6 W, 160 lm – 1,5" ext.		1	0,90	4 380,-
8WT000234	D	Světlo ZODIAC RGBW 12 W, 340 lm – 1,5" ext. Light ZODIAC RGBW 12 W, 340 lm – 1,5" ext.		1	1,00	4 628,-
8WT000235	D	Světlo ZODIAC RGBW 24 W, 505 lm – 1,5" ext. Light ZODIAC RGBW 24 W, 505 lm – 1,5" ext.		1	1,00	4 793,-

Žárovka LED SeaMAID

- RGB – 11 statických barev a 5 programů
- K této žárovce lze použít „Kit pro renovaci světla“



81502655



81502679

Kabelová průchodka pro utěsnění kabelu součástí / Cable gland for cable tightening - included

LED bulb SeaMAID

- RGB – 11 static colors and 5 programs
- Compatible with the „Renovation KIT“

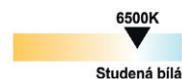
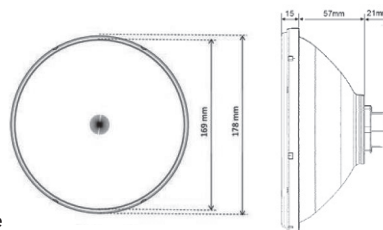

13,5 W = 135 W

Žárovka LED SeaMAID | LED bulb SeaMAID

						cena Kč	€
81502655	B	LED SeaMAID, PAR 56, 90 LED RGB, 16 W, 510 lm, s průchodkou na kabel LED SeaMAID, PAR 56, 90 LED RGB, 16 W, 510 lm, cable bushing		6	0,70	4 677,-	
81502679	B	LED SeaMAID, PAR 56, 60 LED bílé, 13,5 W, 1 650 lm, s průchodkou na kabel LED SeaMAID, PAR 56, 60 LED white, 13,5 W, 1 650 lm, cable bushing		6	0,70	2 488,-	

Žárovka LED-IN SeaMAID

- RGB – 11 statických barev a 5 programů
- Lze zaměnit za 300W žárovku PAR56



81501535



81501542

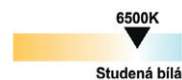
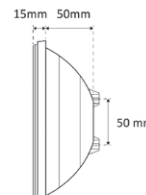
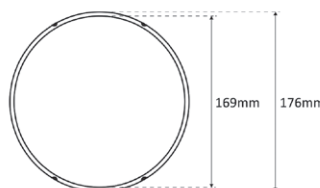

13,5 W = 135 W

Žárovka LED IN | LED IN bulb

						cena Kč	€
81501535	B	LED IN, PAR 56 ploché sklo, 90 LED RGB, 16 W/12 V, 510 lm LED IN, PAR 56 flat glass, 90 LED RGB, 16 W/12 V, 510 lm		6	0,95	4 161,-	
81501542	B	LED IN, PAR 56 ploché sklo, 60 LED bílé, 13,5 W/12 V, 1 650 lm LED IN, PAR 56 flat glass, 60 LED white, 13,5 W/12 V, 1 650 lm		6	0,95	1 750,-	



81501801



81501474



81501412

Příslušenství | Accessories

						cena Kč	€
81501801	B	Dálkové ovládání SeaMAID – 1kanálové Remote control SeaMAID – 1-channel		1	0,50	2 408,-	
81501474	B	Klíčenko k dálkovému ovládání SeaMAID On/Off Remote control SeaMAID On/Off		1	0,10	567,-	
81501412	B	Anténa – prodloužení dosahu rádiového signálu Antenna – extends the range of a radio signal		1	0,50	844,-	

LED žárovka 100 mm

- LED bazénové světlo
- RGB – 16 statických barev
- Instalace do trysky 1½"
- 4m kabel



LED bulb 100 mm

- LED light for swimming pool
- RGB – 16 colors
- Installation to 1½" thread
- 4 m cable

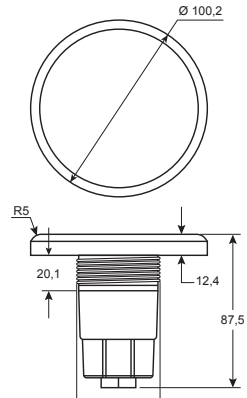
DMX
protocol

LED žárovka 100 mm | LED bulb 100 mm

81HTW101B	B	LED žárovka 100 mm – LED Bílé, 7 W/12 V, 6 500 K, 700 lm, 99 LED LED bulb 100 mm – LED White, 7W/12 V, 6 500 K, 700 lm, 99 LED								2 716,-	€
81HTS101B	B	LED žárovka 100 mm – LED RGB, 6 W/12 V, 300 lm, 99 LED LED bulb 100 mm – LED RGB, 6 W/12 V, 300 lm, 99 LED								2 716,-	€
81HTX101B	B	LED žárovka 100 mm DMX – LED RGB, 6 W/12 V, 300 lm, 99 LED LED bulb 100 mm DMX – LED RGB, 6 W/12 V, 300 lm, 99 LED								3 293,-	€

LED žárovka – Flat

- LED bazénové světlo
- Kompatibilní s 300W žárovkou (lze vyměnit)
- RGB – 16 statických barev
- 4m kabel



LED bulb – Flat

- LED light
- Compatible with 300W bulb (can be replaced)
- RGB – 16 static colors
- 4m cable

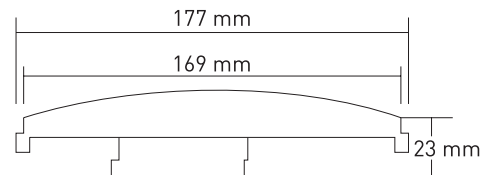

LED žárovka Flat RGB | LED bulb Flat RGB

81HTS301B	B	LED Flat 300, 324 LED RGB, 23 W/12 V, max. příkon 23 W, 1 150 lm LED Flat 300, 324 LED RGB, 23 W/12 V, max. power 23 W, 1 150 lm				6	0,60	4 198,-	€	
81HTS701B	B	LED Flat 700, 531 LED RGB, 33 W/12 V, max. příkon 33 W, 1 650 lm LED Flat 700, 531 LED RGB, 33 W/12 V, max. power 33 W, 1 650 lm				6	0,60	4 857,-	€	

LED žárovka Flat bílé | LED bulb Flat white

81HTW301B	B	LED Flat 300, 252 LED bílé, 21 W/12 V, max. příkon 21 W, 2 100 lm, 6 500 K LED Flat 300, 252 LED white, 21 W/12 V, max. power 21 W, 2 100 lm, 6 500 K				6	0,60	3 786,-	€	
81HTW701B	B	LED Flat 700, 432 LED bílé, 33 W/12 V, max. příkon 33 W, 3 300 lm, 6 500 K LED Flat 700, 432 LED white, 33 W/12 V, max. power 33 W, 3 300 lm, 6 500 K				6	0,60	4 527,-	€	



81PLSREM

Dálkové ovládání | Remote control

81PLSREM	B	Dálkové ovládání + 1 klíčenka pro světla Flat Remote control + 1 keychain controller for lamp Flat				1	0,5	4 330,-	€	

Při použití ploché LED žárovky doporučujeme použít distanční vložku:
03016125480045

When using a flat LED bulb, we recommend using the spacer:
03016125480045

LED žárovka – Flat – DMX

- LED bazénové světlo
- Kompatibilní s 300W žárovkou (lze vyměnit)
- RGB – 16 statických barev
- Komunikace protokolem DMX (inteligentní ovládání světél)
- 4m kabel



LED bulb – Flat – DMX

- LED light
- Compatible with 300W bulb (can be replaced)
- RGB – 16 static colors
- DMX protocol communication (intelligent light control)
- 4m cable

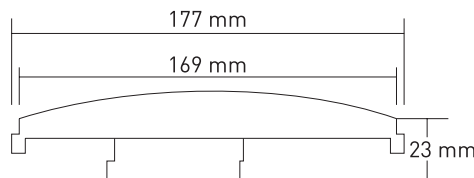

Lze propojit a ovládat pomocí VARIO DIN LIGHTS modulu
Can be connected and controlled by VARIO DIN LIGHTS module

DMX
protocol

LED žárovka Flat DMX – RGB LED bulb Flat DMX – RGB						cena Kč	€
81HTX301B	B	LED Flat 300 DMX, 324 LED RGB, 23 W/12 V, max. příkon 23 W, 1 150 lm LED Flat 300 DMX, 324 LED RGB, 23 W/12 V, max. power 23 W, 1 150 lm		6	0,60	5 103,-	
81HTX701B	B	LED Flat 700 DMX, 531 LED RGB, 33 W/12 V, max. příkon 33 W, 1 650 lm LED Flat 700 DMX, 531 LED RGB, 33 W/12 V, max. power 33 W, 1 650 lm		6	0,60	5 927,-	
81HTX901B	B	LED Flat 900 DMX, 630 LED RGB, 55 W/12 V, max. power 55 W, 2 750 lm LED Flat 900 DMX, 630 LED RGB, 55 W/12 V, max. power 55 W, 2 750 lm		6	0,60	7 902,-	

Ovládání světél DMX

- DMX – „Digital Multiplex“ je digitální komunikační protokol pro řízení RGB světél
- Výběr z celé palety RGB barev (tvorba vlastních barevných scén)
- Wi-Fi – pro ovládání přes aplikaci chytrým telefonem
- Dálkové ovládání lze dokoupit samostatně

Balení se skládá z DMX modulu a bezpečnostního stabilizovaného zdroje – umístěno v boxu.

DMX light control

- DMX – „Digital Multiplex“ is a digital communication protocol for controlling RGB lights
- Choose from the entire RGB color palette (create your own color scenes)
- Wi-Fi – for control via smartphone app
- Remote control can be bought separately

Package consists of DMX module and safety stabilized source and it all comes in a box.



895150DMX
895300DMX



895DMXRC



895DMX

DMX
protocol

Technické údaje / Technical data	895150DMX	895300DMX
Výkon / Power	150 W	300 W
Vstupní napětí / Input voltage	175 - 264 V AC; 50/60 Hz	
Výstupní napětí / Output voltage	12 V DC	
Výstupní proud / Output current	Max. 12,5 A	Max. 25 A
Stupeň krytí / Index protection	IP67	
Materiál krytu / Cover material	Hliník / Aluminum	
Druh / Type	SELV	

Při výběru zdroje počítejte s výkonovou rezervou min. 20 %.
When choosing a power supply, keep in mind power reserve of at least 20 %.

Řízení DMX světél s bezpečnostním zdrojem | DMX controller with safety power supply

Řízení DMX světél s bezpečnostním zdrojem DMX controller with safety power supply						cena Kč	€
895DMX	B	Modul pro řízení DMX DMX controller module		1	0,70	6 274,-	
895DMXRC	B	Dálkové ovládání DMX modulu Remote control for DMX controller		1	0,10	1 124,-	
895150DMX	B	Řízení DMX + bezpečnostní zdroj pro bazénová světla – 12 V/12,5 A – 150 W DMX controller + safety power supply for underwater lights – 12 V/12,5 A – 150 W		1	0,70	10 038,-	
895300DMX	B	Řízení DMX + bezpečnostní zdroj pro bazénová světla – 12 V/25 A – 300 W DMX controller + safety power supply for underwater lights – 12 V/25 A – 300 W		1	1,00	10 791,-	

Bazénová světla VA-LIGHT

- Vyrobeno v Evropě
- Varianty provedení
- VAPF / VAPB
Světla určená pro instalaci do fóliových, předvyrobených a betonových bazénů (dle označení F/B). Plastový hrnec, plastová příruba, EPDM těsnění a plastový rámeček.
Barvy rámečku – bílá, RAL1015, RAL7004 a RAL7016
- VAHF / VAHB
Světla určená pro instalaci do fóliových, předvyrobených a betonových bazénů (dle označení F/B). Plastový hrnec, nerezová příruba, EPDM těsnění a nerezový rámeček.
- VANF / VANB
Světla určená pro instalaci do fóliových, předvyrobených a betonových bazénů (dle označení F/B). Nerezový hrnec, nerezová příruba, EPDM těsnění a nerezový rámeček.

Underwater light VA

- Made in Europe
- Versions
- VAPF / VAPB
Lights designed for installation in foil, prefabricated and concrete pools (according to F/B designation). Plastic pot, plastic flange, EPDM gasket and plastic frame.
Frame colors - white, RAL1015, RAL7004 and RAL7016
- VAHF / VAHB
Lights designed for installation in foil, prefabricated and concrete pools (according to F/B designation). Plastic pot, stainless steel flange, EPDM gasket and stainless steel frame.
- VANF / VANB
Lights designed for installation in foil, prefabricated and concrete pools (according to F/B designation). Stainless steel pot, stainless steel flange, EPDM gasket and stainless steel frame.

VALight

Vysvětlení kódu | Code explanation

85	Interní označení	Intern code
VA	Vlastní produkt	Own product
P	Materiál – světla „P” – Plastové „H” – Plastové + nerez „N” – Celonerezové	Material (of the light) „P” – Plastic „H” – Plastic + St. steel „N” – Full st. steel
F	Typ bazénu „F” – fóliový „B” – Betonový	Pool type „F” – Liner „B” – Concrete
16	Výkon žárovky (W)	Bulb power (W)
W	Typ žárovky „W” – bílá „R” – RGB	Bulb type „W” – white „R” – RGB
4	Barevné provedení rámečku „prázdné” – bílá „4” – světle šedá RAL7006 „5” – tmavě šedá RAL7016 „6” – písková RAL1015	Color of the front cover „empty” – white „4” – light gray RAL7006 „5” – dark grey RAL7016 „6” – sand RAL1015



Příklad / Example:

85VAPF16W



Příklad / Example:

85VAPF16W4

Příplatek za barevné provedení: + 10 % (oproti bílé variantě)
Surcharge for colored version: 10% [compared to white version]



Příklad / Example:

85VAPF16W5

Příplatek za barevné provedení: + 10 % (oproti bílé variantě)
Surcharge for colored version: 10% [compared to white version]

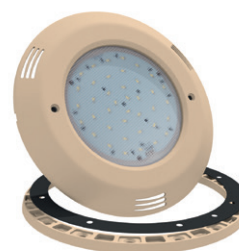

Příklad / Example:

85VAPF16W6

Příplatek za barevné provedení: + 10 % (oproti bílé variantě)
Surcharge for colored version: 10% [compared to white version]

Světlo VA – PF

- Pro fóliové bazény
- ABS, příruba + těsnění, plastový rámeček

Underwater light VA – PF

- For liner pools
- ABS, flange + gaskets, plastic frame

VALight

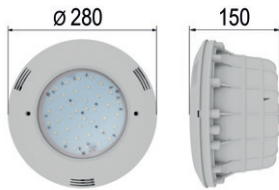

VA – PF	Žárovka Bulb	Barva / Colour		Svítivost Lumens	Výkon Output	Napětí Supply	Typ bazénu Pool type	KG	cena Kč	€
		White	RGB							
85VAPF300	B STANDARD 300 W				300 W	12 V	Fóliový / Liner		2 449,-	
85VAPF16W	B 81501542			1 650 lm	13,5 W	12 V	Fóliový / Liner		3 845,-	
85VAPF21W	B 81HTW301B			2 100 lm	21 W	12 V	Fóliový / Liner		5 050,-	
85VAPF33W	B 81HTW701B			3 300 lm	33 W	12 V	Fóliový / Liner		5 632,-	
85VAPF16R	B 81501535			510 lm	16 W	12 V	Fóliový / Liner		6 230,-	
85VAPF23R	B 81HTS301B			1 150 lm	23 W	12 V	Fóliový / Liner		5 373,-	
85VAPF33R	B 81HTS701B			1 650 lm	33 W	12 V	Fóliový / Liner		5 890,-	
85VAPF23X	B HTX301B (DMX)			1 150 lm	23 W	12 V	Fóliový / Liner		6 669,-	
85VAPF33X	B HTX701B (DMX)			1 650 lm	33 W	12 V	Fóliový / Liner		7 385,-	
85VAPF55X	B HTX901B (DMX)			2 750 lm	55 W	12 V	Fóliový / Liner		9 103,-	
85VAPF	B ABS hrnec, příruba + těsnění, plastový rámeček ABS niche, flange + gaskets, plastic frame								2 122,-	

Světlo VA – PB

- Pro betonové bazény
- ABS, plastový rámeček

Underwater light VA – PB

- For concrete pools
- ABS, plastic frame

VALight

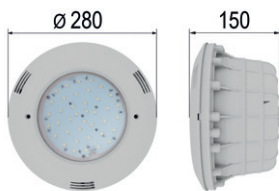

VA – PB	Žárovka Bulb	Barva / Colour		Svítivost Lumens	Výkon Output	Napětí Supply	Typ bazénu Pool type	KG	cena Kč	€
		White	RGB							
85VAPB300	B STANDARD 300 W				300 W	12 V	Betonový / Concrete		1 698,-	
85VAPB16W	B 81501542			1 650 lm	13,5 W	12 V	Betonový / Concrete		3 094,-	
85VAPB21W	B 81HTW301B			2 100 lm	21 W	12 V	Betonový / Concrete		4 283,-	
85VAPB33W	B 81HTW701B			3 300 lm	33 W	12 V	Betonový / Concrete		4 864,-	
85VAPB16R	B 81501535			510 lm	16 W	12 V	Betonový / Concrete		5 478,-	
85VAPB23R	B 81HTS301B			1 150 lm	23 W	12 V	Betonový / Concrete		4 606,-	
85VAPB33R	B 81HTS701B			1 650 lm	33 W	12 V	Betonový / Concrete		5 123,-	
85VAPB23X	B HTX301B (DMX)			1 150 lm	23 W	12 V	Betonový / Concrete		5 831,-	
85VAPB33X	B HTX701B (DMX)			1 650 lm	33 W	12 V	Betonový / Concrete		6 547,-	
85VAPB55X	B HTX901B (DMX)			2 750 lm	55 W	12 V	Betonový / Concrete		8 266,-	
85VAPB	B ABS hrnec, plastový rámeček ABS niche, plastic frame								1 338,-	

Světlo VA – HF

- Pro fóliové bazény
- ABS hrnec, nerezová příruba + těsnění, nerezový rámeček

Underwater light VA – HF

- For liner pools
- ABS niche, stainless steel flange + gaskets and stainless steel frame

VALight

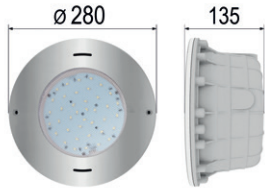

VA – HF	Žárovka Bulb	Barva / Colour		Svitivost Lumens	Výkon Output	Napětí Supply	Typ bazénu Pool type	KG	cena Kč	€
		White	RGB							
85VAHF21W	B 81HTW301B			2 100 lm	21 W	12 V	Fóliový / Liner		10 936,-	
85VAHF33W	B 81HTW701B			3 300 lm	33 W	12 V	Fóliový / Liner		11 518,-	
85VAHF23R	B 81HTS301B			1 150 lm	23 W	12 V	Fóliový / Liner		11 259,-	
85VAHF33R	B 81HTS701B			1 650 lm	33 W	12 V	Fóliový / Liner		11 777,-	
85VAHF23X	B HTX301B (DMX)			1 150 lm	23 W	12 V	Fóliový / Liner		13 239,-	
85VAHF33X	B HTX701B (DMX)			1 650 lm	33 W	12 V	Fóliový / Liner		13 954,-	
85VAHF55X	B HTX901B (DMX)			2 750 lm	55 W	12 V	Fóliový / Liner		15 673,-	

Světlo VA – HB

- Pro betonové bazény
- ABS hrnec,
nerezový rámeček

Underwater light VA – HB

- For concrete pools
- ABS niche,
stainless steel frame

VALight

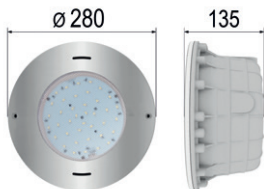

VA – HB	Žárovka Bulb	Barva / Colour		Svitivost Lumens	Výkon Output	Napětí Supply	Typ bazénu Pool type	KG	cena Kč	€
		White	RGB							
85VAHB21W	B 81HTW301B			2 100 lm	21 W	12 V	Betonový / Concrete		8 465,-	
85VAHB33W	B 81HTW701B			3 300 lm	33 W	12 V	Betonový / Concrete		9 047,-	
85VAHB23R	B 81HTS301B			1 150 lm	23 W	12 V	Betonový / Concrete		8 788,-	
85VAHB33R	B 81HTS701B			1 650 lm	33 W	12 V	Betonový / Concrete		9 305,-	
85VAHB23X	B HTX301B (DMX)			1 150 lm	23 W	12 V	Betonový / Concrete		10 158,-	
85VAHB33X	B HTX701B (DMX)			1 650 lm	33 W	12 V	Betonový / Concrete		10 874,-	
85VAHB55X	B HTX901B (DMX)			2 750 lm	55 W	12 V	Betonový / Concrete		12 592,-	

Světlo VA – NF

- Pro fóliové bazény
- Nerezový hrnec, nerezová příruba + těsnění, nerezový rámeček

Underwater light VA – NF

- For liner pools
- Stainless steel niche, flange + gaskets and stainless steel frame

VALight

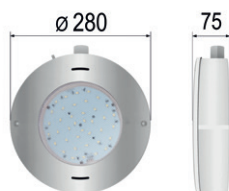

VA – NF		Žárovka Bulb	Barva / Colour		Svítivost Lumens	Výkon Output	Napětí Supply	Typ bazénu Pool type	KG	cena Kč	€
			White	RGB							
85VANF21W	B	81HTW301B			2 100 lm	21 W	12 V	Fóliový / Liner		22 128,-	
85VANF33W	B	81HTW701B			3 300 lm	33 W	12 V	Fóliový / Liner		22 710,-	
85VANF23R	B	81HTS301B			1 150 lm	23 W	12 V	Fóliový / Liner		22 451,-	
85VANF33R	B	81HTS701B			1 650 lm	33 W	12 V	Fóliový / Liner		22 968,-	
85VANF23X	B	HTX301B (DMX)			1 150 lm	23 W	12 V	Fóliový / Liner		25 630,-	
85VANF33X	B	HTX701B (DMX)			1 650 lm	33 W	12 V	Fóliový / Liner		26 345,-	
85VANF55X	B	HTX901B (DMX)			2 750 lm	55 W	12 V	Fóliový / Liner		28 064,-	

Světlo VA – NB

- Pro betonové a nerezové bazény
- Nerezový hrnec, nerezový rámeček

Underwater light VA – NB

- For concrete and stainless steel pools
- Stainless steel niche, stainless steel frame

VALight

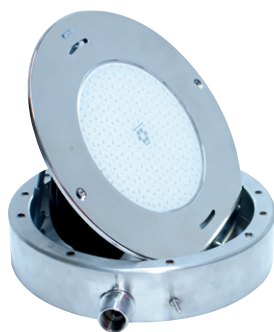
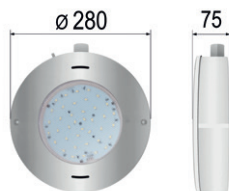

VA – NB		Žárovka Bulb	Barva / Colour		Svítivost Lumens	Výkon Output	Napětí Supply	Typ bazénu Pool type	KG	cena Kč	€
			White	RGB							
85VANB21W	B	81HTW301B			2 100 lm	21 W	12 V	Betonový / Concrete		19 478,-	
85VANB33W	B	81HTW701B			3 300 lm	33 W	12 V	Betonový / Concrete		20 060,-	
85VANB23R	B	81HTS301B			1 150 lm	23 W	12 V	Betonový / Concrete		19 801,-	
85VANB33R	B	81HTS701B			1 650 lm	33 W	12 V	Betonový / Concrete		20 318,-	
85VANB23X	B	HTX301B (DMX)			1 150 lm	23 W	12 V	Betonový / Concrete		22 696,-	
85VANB33X	B	HTX701B (DMX)			1 650 lm	33 W	12 V	Betonový / Concrete		23 412,-	
85VANB55X	B	HTX901B (DMX)			2 750 lm	55 W	12 V	Betonový / Concrete		25 130,-	

Podvodní světlo VA MALÉ NEREZ

- Pro fólii – včetně příruby a dvou těsnění
- Ochranná hadice el. kabelu
- Samořezné šrouby
- Kabel 3 m

Underwater light Hayward

- For liner – with fl ange and two gaskets
- With protective hose
- Self-tapping screws
- 3 m cable

VALight

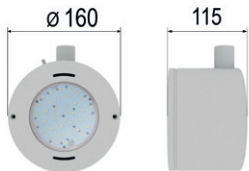

85VSNF...

85VSNB...



VA – NF	Žárovka Bulb	Barva / Colour		Svitivost Lumens	Výkon Output	Napětí Supply	Typ bazénu Pool type	KG	cena Kč	€
		White	RGB							
85VSNF7W	B 81HTW101B			700 lm	7 W	12 V	Fóliový / Liner		13 817,-	
85VSNF6R	B 81HTR101B			300 lm	6 W	12 V	Fóliový / Liner		13 817,-	
85VSNF6X	B 81HTX101B			300 lm	6 W	12 V	Fóliový / Liner		15 799,-	

VS – NB	Žárovka Bulb	Barva / Colour		Svitivost Lumens	Výkon Output	Napětí Supply	Typ bazénu Pool type	KG	cena Kč	€
		White	RGB							
85VSNB7W	B 81HTW101B			700 lm	7 W	12 V	Betonový / Concrete		12 504,-	
85VSNB6R	B 81HTR101B			300 lm	6 W	12 V	Betonový / Concrete		12 504,-	
85VSNB6X	B 81HTX101B			300 lm	6 W	12 V	Betonový / Concrete		14 344,-	

LED ploché světlo

- Bílé
- Délka kabelu 3 m
- Upevnění pomocí nosného kříže

LED flat light

- White
- Cable length 3 m
- To be fitted with support cross

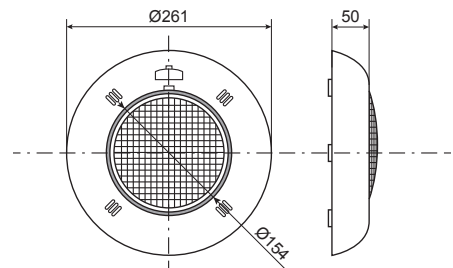

LED ploché světlo | LED flat light

LED ploché světlo LED flat light		KG	cena Kč	€
80600LED14W	B LED ploché světlo, Bílé, 14,5 W, 1 485 lm LED flat light, White, 14,5 W, 1 485 lm		4 894,-	

Žárovka | Bulb

Žárovka Bulb		KG	cena Kč	€
801303	B Žárovka 300 W/12 V Bulb 300 W/12 V		639,-	



Podvodní světlo Hayward

- Pro fólii – včetně příruby a dvou těsnění
- Ochranná hadice el. kabelu
- Samořezné šrouby
- Kabel 3 m

Underwater light Hayward

- For liner – with flange and two gaskets
- With protective hose
- Self-tapping screws
- 3 m cable

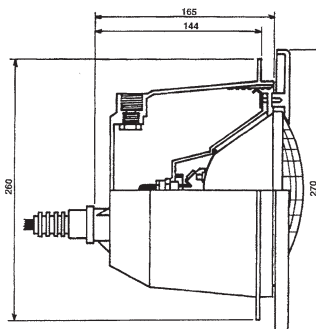

853481

Podvodní světlo Design Underwater light Design		KG	cena Kč	€
853481	B Podvodní světlo Design 300 W – pro fólii Underwater light Design 300 W – for liner	3,0	3 366,-	

DESIGN LED	Žárovka Bulb	Barva / Colour		Svitivost Lumens	Výkon Output	Napětí Supply		KG	cena Kč	€
		White	RGB							
853481LED13W	B LED – Originál			1 450 lm	13 W	12 V		3,0	5 948,-	
853481LED16W	B LED PAR 56 – 81501542			1 650 lm	13,5 W	12 V		3,0	5 158,-	
853481LED21W	B LED Plochá – 81HTW301B			2 100 lm	21 W	12 V		3,0	7 709,-	
853481LED33W	B LED Plochá – 81HTW701B			3 300 lm	33 W	12 V		3,0	6 987,-	
853481LED16R	B LED PAR 56 – 81501535			510 lm	16 W	12 V		3,0	7 534,-	
853481LED17R	B LED – Originál			600 lm	16 W	12 V		3,0	11 033,-	
853481LED23R	B LED Plochá – 81HTS301B			1 150 lm	23 W	12 V		3,0	6 987,-	
853481LED33R	B LED Plochá – 81HTS701B			1 650 lm	33 W	12 V		3,0	7 655,-	

Ploché světlo SeaMAID

- Kabel 2 m v balení
- Instalace 1,5" ext. závit
- RGB – 11 statických barev a 5 programů

Flat light SeaMAID

- 2 m cable included
- Installation 1,5" ext. thread
- RGB – 11 static colors and 5 programs



85501191



85501160

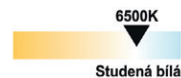
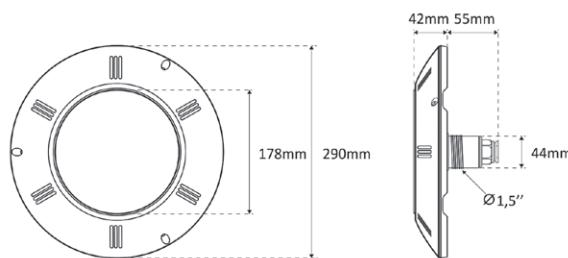

13,5 W = 135 W

Světlo SeaMAID Light SeaMAID		KG	cena Kč	€
85501191	B Světlo SeaMAID ploché, 90 LED RGB, 16 W/12 V, 510 lm Light SeaMAID flat, 90 LED RGB, 16 W/12 V, 510 lm	1,5	5 518,-	
85501160	B Světlo SeaMAID ploché, 60 LED bílé, 13,5 W/12 V, 1 650 lm Light SeaMAID flat, 60 LED white, 13,5 W/12 V, 1 650 lm	1,5	3 562,-	

Při použití ploché LED žárovky doporučujeme použít distanční vložku: 03016125480045

When using a flat LED bulb, we recommend using the spacer: 03016125480045

Bezpečnostní transformátory

Pro 50–300W světla. Jsou umístěny v krabičce ze speciálního termo-odolného plastu, 600 a 900 W jsou v ocelové krabici s lakovaným povrchem vysoké kvality.



Safety transformers

For 50–300 W lights. Transformers are placed in a thermo-resistant plastic box while the 600 W/900 W versions are covered with steel box with high quality varnished surface.

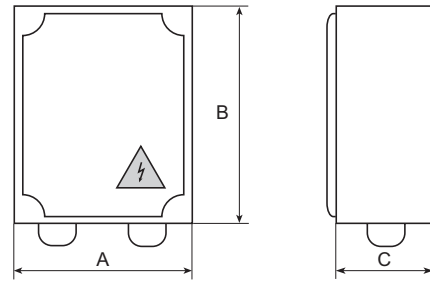

	A	B	C
50 W	140	175	115
100 W	140	175	115
200 W	140	175	155
300 W	140	175	155
600 W	200	220	175
900 W	200	220	175

Bezpečnostní transformátor | Safety - transformer

					cena Kč	€	
890050	B	Bezpečnostní transformátor 230 V/12 V, 50 W, krytí IP65 Safety - transformer 230 V/12 V, 50 W, protection IP65			1	2,55	2 013,-
890100	B	Bezpečnostní transformátor 230 V/12 V, 100 W, krytí IP65 Safety - transformer 230 V/12 V, 100 W, protection IP65			1	2,82	2 290,-
890200	B	Bezpečnostní transformátor 230 V/12 V, 200 W, krytí IP65 Safety - transformer 230 V/12 V, 200 W, protection IP65			1	4,80	2 795,-
890300	B	Bezpečnostní transformátor 230 V/12 V, 300 W, krytí IP65 Safety - transformer 230 V/12 V, 300 W, protection IP65			1	5,63	3 435,-
890600	B	Bezpečnostní transformátor 230 V/12 V, 600 W (2 x 300 W), krytí IP65 Safety - transformer 230 V/12 V, 600 W (2 x 300 W), protection IP65			1	14,10	6 688,-
890900	B	Bezpečnostní transformátor 230 V/12 V, 900 W (3 x 300 W), krytí IP65 Safety - transformer 230 V/12 V, 900 W (3 x 300 W), protection IP65			1	15,20	8 567,-

Bezpečnostní transformátor zalitý | Safety - transformer

					cena Kč	€	
8900501	B	Bezpečnostní transformátor 230 V/12 V, 50 W, krytí IP54 Safety - transformer 230 V/12 V, 50 W, protection IP54			1	1,8	1 779,-
8901001	B	Bezpečnostní transformátor 230 V/12 V, 100 W, krytí IP54 Safety - transformer 230 V/12 V, 100 W, protection IP54			1	2,2	1 955,-
8902001	B	Bezpečnostní transformátor 230 V/12 V, 200 W, krytí IP54 Safety - transformer 230 V/12 V, 200 W, protection IP54			1	3,5	2 532,-
8903001	B	Bezpečnostní transformátor 230 V/12 V, 300 W, krytí IP54 Safety - transformer 230 V/12 V, 300 W, protection IP54			1	5,5	3 034,-

Bezpečnostní transformátor | Safety - transformer

					cena Kč	€	
890040	B	Bezpečnostní transformátor pro LED 230 V/12 V, 40 W, krytí IP65 Safety - transformer for LED 230 V/12 V, 40 W, protection IP65			1	2,0	1 825,-
890080	B	Bezpečnostní transformátor pro LED 230 V/12 V, 80 W, krytí IP65 Safety - transformer for LED 230 V/12 V, 80 W, protection IP65			1	2,5	2 139,-
890170	B	Bezpečnostní transformátor pro LED 230 V/12 V, 170 W, krytí IP65 Safety - transformer for LED 230 V/12 V, 170 W, protection IP65			1	3,0	2 431,-

Bezpečnostní transformátor zalitý | Safety - transformer

					cena Kč	€	
8900401	B	Bezpečnostní transformátor pro LED 230 V/12 V, 40 W, krytí IP54 Safety - transformer for LED 230 V/12 V, 40 W, protection IP54			1	2,0	1 779,-
8900801	B	Bezpečnostní transformátor pro LED 230 V/12 V, 80 W, krytí IP54 Safety - transformer for LED 230 V/12 V, 80 W, protection IP54			1	2,5	1 917,-
8901701	B	Bezpečnostní transformátor pro LED 230 V/12 V, 170 W, krytí IP54 Safety - transformer for LED 230 V/12 V, 170 W, protection IP54			1	3,0	2 369,-

Bezpečnostní transformátor toroidní | Safety - transformer toroid

					cena Kč	€	
8901002	B	Bezpečnostní transformátor toroidní 230 V/12 V, 100 W, krytí IP65 Safety - transformer toroid 230 V/12 V, 100 W, protection IP65			1	2,0	3 053,-
8902002	B	Bezpečnostní transformátor toroidní 230 V/12 V, 200 W, krytí IP65 Safety - transformer toroid 230 V/12 V, 200 W, protection IP65			1	2,5	3 605,-
8903002	B	Bezpečnostní transformátor toroidní 230 V/12 V, 300 W, krytí IP65 Safety - transformer toroid 230 V/12 V, 300 W, protection IP65			1	3,2	4 584,-

Jak postupovat při plánování elektroinstalace světel

Pro LED světla se musí vždy použít toroidní transformátor.

How to choose a transformer for Adagio Pro

For LED lights Adagio PRO a toroid transformer is always required.

Varianta A – pokud je každá žárovka připojena ke zdroji vlastním vodičem/kabelem.

OPTION A – if each light is connected to the source with its own wire/cable.

Výběr průřezu a možné délky kabelu pro LED světla | Selection of cross-section and possible cable length for LED lights

Výkon světla Light power	Průřez drátu/vodiče Conductor cross section				
	1,5 mm ²	2,5 mm ²	4,0 mm ²	6,0 mm ²	10,0 mm ²
30W	21 m	35 m	57 m	85 m	142 m
45W	12 m	20 m	33 m	50 m	80 m
60W	4 m	7 m	11 m	16 m	28 m
75W	6 m	10 m	16 m	25 m	42 m

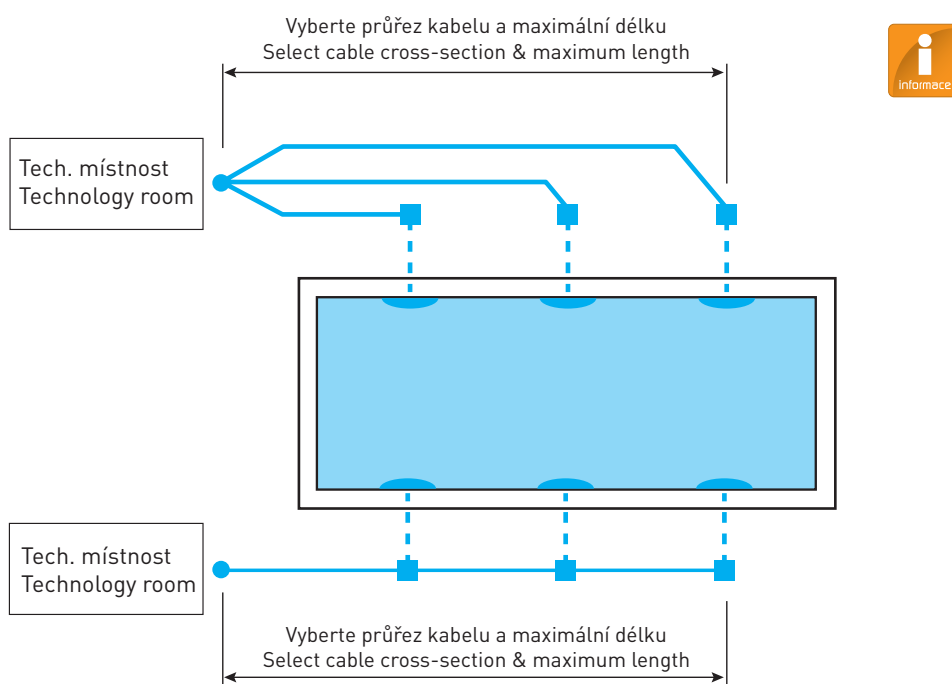

Varianta B – pokud jsou všechny žárovky spojeny s transformátorem pomocí jednoho vodiče/kabelu.

Option B – All lamps are connected to the transformer with the same cable.

Výběr průřezu a možné délky kabelu pro LED světla | Selection of cross-section and possible cable length for LED lights

Výkon světla Light power	Počet žárovek Number of bulbs	Průřez drátu/vodiče Conductor cross section			
		2,5 mm ²	4,0 mm ²	6,0 mm ²	10,0 mm ²
30W	1	35 m	57 m	85 m	142 m
	2	17 m	28 m	42 m	71 m
	3	11 m	19 m	28 m	47 m
	4	8 m	14 m	21 m	35 m
45W	1	20 m	33 m	50 m	80 m
	2	10 m	16 m	25 m	40 m
	3	-	11 m	16 m	26 m
	4	-	8 m	12 m	20 m
60W	1	7 m	11 m	16 m	28 m
	2	-	5 m	8 m	14 m
	3	-	-	5 m	9 m
	4	-	-	-	7 m
75W	1	10 m	16 m	25 m	42 m
	2	-	8 m	12 m	21 m
	3	-	5 m	8 m	14 m
	4	-	-	6 m	10 m

LED světla Adagio PRO

- Vysoká svítivost (bílá 2 600 až 5 500 lm, barevná 1 700 až 3 000 lm)
- 3 odstíny bílé: (Sluneční bílá, Neutrální bílá a teplá bílá - pouze u RGB světel)
- 11 barevných modů
- 4 metry dlouhý kabel součástí světla
- Instalace pomocí instalačního prvku 1,5"
- Adagio 170 vhodné do světel PAR56 (60 W, 75 W)
- K napájení je nutno použít toroidní transformátor
- Doporučujeme použít přepěťovou ochranu



85100RAWH



85100RASS



85WH30PRO



85RGB45PRO

Rámečky lze libovolně kombinovat
Adagio light frames freely combinable

LED lights Adagio PRO

- High luminosity (white 2 600–5 500 lm; RGB 1 700–3 000 lm)
- 3 White tones: (Sun White, Neutral White and warm white - only for RGB lights)
- 11 Color modes
- 4 meter cable (2-core) is included
- Can be installed in our wall conduits or in any 1,5" standard inlet
- Fit in PAR56 type underwaterlight (only PLA170) (60 W, 75 W)
- Toroidal transformer required
- Surge protection recommended

LED světlo Adagio PRO 100 | LED Light Adagio PRO 100

						cena Kč	€
85WH30PRO	B	LED bílé světlo 30 W, svítivost 2 600 lm, Ø 10 cm, 5 000 K LED white lamp 30 W, luminosity 2 600 lm, Ø 10 cm, 5 000 K		1	0,60	6 652,-	
85RGB45PRO	B	LED barevné RGB světlo 45 W, svítivost 1 700 lm, Ø 10 cm LED color RGB lamp 45 W, luminosity 1 700 lm, Ø 10 cm		1	0,60	10 280,-	
85100RASS	B	Rámeček světla nerez, Ø 10/17,5 cm Frame for lamp stainless steel Ø 10/17,5 cm		1	0,3	2 056,-	
85100RAWH	B	Rámeček světla bílý, Ø 10/17,5 cm Frame for lamp white Ø 10/17,5 cm		1	0,3	919,-	

Dálkové ovládání a příslušenství

- Funkce stmívání (pouze 81PLPREM)
- Možnost propojení s inteligentním domem



81PLSREM / 81PLPREM



855130151

Remote control and accesories

- Dimming function (only 81PLPREM)
- Smart home compatible



85WTMS

Příslušenství | Accesories

						cena Kč	€
81PLSREM	B	Dálkové ovládání + 1 klíčenka Remote control + 1 key case		1	0,5	4 330,-	
81PLPREM	B	Dálkové ovládání + klíčenka (s funkcí stmívání) Remote control + key case (with dimming function)		1	0,5	8 901,-	
85WTMS	B	Instalační prvek s přírubou pro fólii Installation component with flange for liner		1	0,5	1 427,-	
855130151	X	Montážní klíč pro instalační prvek Montage key for installation component		1		198,-	

Magnetické světlo SeaMAID

- Magnetická záda
- Není nutné instalovat pod hladinu vody
- Lze umístit do zahrady, do strojovny
- 18 LED
- Baterie: 3 200 mAh

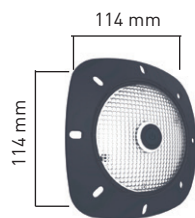

Magnetic light SeaMAID

- Magnetic base
- Not necessary to install below the waterline
- Can be used wherever you want: garden, technical room
- 18 LED
- Battery: 3 200 mAh

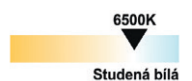
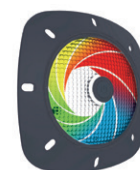

2 W = 20 W

Magnetické světlo | Magnetic light

						cena Kč	€
85502013	B	Magnetické světlo SeaMAID – šedý rámeček, 18 LED bílé, 2 W, 200 lm Magnetic light SeaMAID – grey frame, 18 LED white, 2 W, 200 lm		1	0,30	1 033,-	
85502112	B	Magnetické světlo SeaMAID – šedý rámeček, 18 LED RGB, 4 W, 100 lm Magnetic light SeaMAID – grey frame, 18 LED RGB, 4 W, 100 lm		1	0,30	1 033,-	

Světlo MTS

Světla MTS mají vždy nastavitelný reflektor, mosazné zástříky a 3m dlouhý kabel

MTS 300 W

- Svítivost 3 300 lm
- Výkon 300 W/12 V

MTS 300 W

- Luminosity 3 300 lm
- Power 300 W/12 V

Žárovka
300 W



Underwater MTS

MTS lights always come with adjustable lamp, brass inserts and 3m cable

Podvodní světlo MTS 300 W | Underwater light MTS 300 W

	85535	8553	855358	8533
	B	B	B	B
	bílé ABS / ABS white	plast ABS / ABS plastic	šedé ABS / ABS grey	nerez / st. steel
	3,10	3,10	3,10	3,50
cena Kč	7 940,-	8 186,-	8 322,-	14 888,-

MTS LED - white

- Výkon 13,5 W/12 V (SeaMAID 81501542)
- Svítivost 1 650 lm

MTS LED - white

- Power 13,5 W/12 V (SeaMAID 81501542)
- Luminosity 1 650 lm

LED
bílé
13,5 W

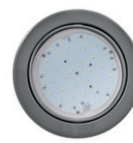

Podvodní světlo MTS LED - white | Underwater light MTS LED - white

	85535LED16W	8553LED16W	855358LED16W	8533LED16W
	B	B	B	B
	bílé ABS / ABS white	plast ABS / ABS plastic	šedé ABS / ABS grey	nerez / st. steel
	3,10	3,10	3,10	3,50
cena Kč	8 216,-	10 079,-	8 524,-	13 795,-

MTS LED - RGB

- Výkon LED 16 W/12 V (SeaMAID 81501535)
- Svítivost 510 lm

MTS LED - RGB

- Power 16 W/ 12 V (SeaMAID 81501535)
- Luminosity 510 lm

LED
RGB
16 W

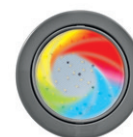

Podvodní světlo MTS LED - RGB | Underwater light MTS LED - RGB

	85535LED16R	8553LED16R	855358LED16R	8533LED16R
	B	B	B	B
	bílé ABS / ABS white	plast ABS / ABS plastic	šedé ABS / ABS grey	nerez / st. steel
	3,10	3,10	3,10	3,50
cena Kč	11 297,-	11 912,-	10 237,-	15 694,-

Příslušenství pro bazénová světla

Pool lights accessories



873495VA

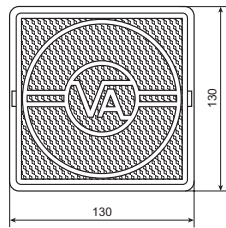

HPR20018



8701



06109240081

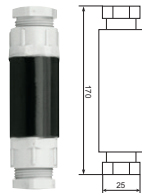

8705, 8707

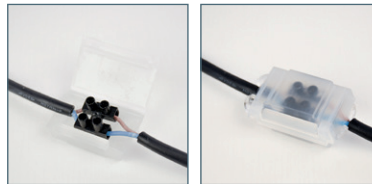

81500338



8706

Příslušenství | Accessories

						cena Kč	€	
873495VA	B	Kabelová propojovací krabice VA Cable interconnecting box VA				1	0,34	345,-
8701	B	Kabelová propojovací krabice MTS, PG 29/21/13,5 Cable interconnecting box MTS, PG 29/21/13,5				60	0,30	1 028,-
8705	B	Kabelové prodloužení PG 16 Cable extension PG 16				1	0,10	237,-
8707	B	Kabelové prodloužení PG11 – pro LED Cable extension PG11 - for LED				1	0,10	147,-
81500338	B	GEL BOX pro kabel 3 x 6 mm ² (IP68) GEL BOX for 3 x 6 mm ² WIRE – IP68				1	0,06	387,-
8706	B	Zalévací hmota pro kabelové propojovací krabice Sealing substance for cable interconnecting box				18	0,60	400,-
HPR20018	B	Kabelová propojovací hadice Connecting cable hose				1	0,15	267,-
06109240081	B	Silikonový kabel 2 x 4 mm ² Silicon cable 2 x 4 mm ²					0,40	164,-

Kit pro renovaci světla

Renovation kit



81502372



81502374

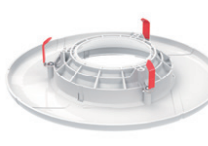

81512372

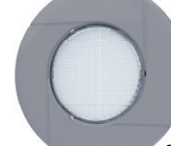

81512374

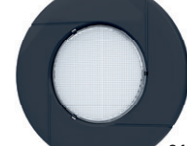

81512375

Kompatibilní se světly různých výrobců – PAR56 / Compatible with lights of various manufacturers – PAR56

Příslušenství | Accessories

						cena Kč	€
81502372	B	Sada pro renovaci světla 300W světla – bílý rámeček Renovation kit for 300W light – white frame		1	0,30	1 254,-	
81502374	B	Sada pro renovaci světla 300W světla – světle šedý rámeček Renovation kit for 300W light – light grey frame		1	0,30	1 254,-	
81512372	B	Sada „Click“ pro renovaci světla 300W světla – bílý rámeček Renovation kit „Click“ for 300W light – white frame		1	0,30	1 254,-	
81512374	B	Sada „Click“ pro renovaci světla 300W světla – světle šedý rámeček Renovation kit „Click“ for 300W light – light grey frame		1	0,30	1 254,-	
81512375	B	Sada „Click“ pro renovaci světla 300W světla – tmavě šedý rámeček Renovation kit „Click“ for 300W light – dark grey frame		1	0,30	1 254,-	

„Kit pro renovaci světla“ obsahuje rámeček a šrouby a kovové příchytky.

The „Renovation Kit“ includes a frame and screws and metal clips.