

Skimmery .....	38	Skimmers .....	38
Dopouštění vody .....	46	Water level controller .....	46
Podlahové výpusti .....	48	Main drains .....	48
Sání .....	51	Suction .....	52
Podlahové trysky, výpusti .....	54	Bottom closing nozzles, outlets .....	54
Nerez trysky .....	55	Stainless steel nozzles .....	55
Trysky .....	58	Nozzles .....	58
Hydromasážní systémy .....	64	Hydromassage systems .....	64
Masážní trysky .....	66	Massage nozzles .....	66
Masážní trysky Hugo Lahme .....	67	Massage nozzles Hugo Lahme .....	67
Masážní čerpadla .....	68	Massage pumps .....	68

# 3

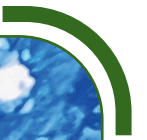

**Závěsný skimmer**

Vhodný pro jakýkoli bazén, ale zejména pro již postavené. Je určen pro dodatečnou montáž a je vybaven zpětným vtokem do bazénu, možnost připojení čisticích zařízení hadicí DN 32 mm. Možnost napojení vysavače.

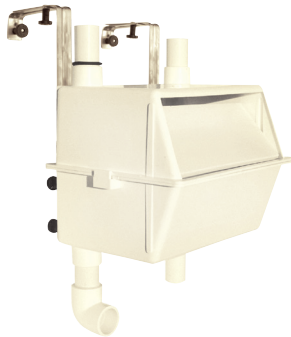

10031

**Wall-mounted skimmer**

Suitable for any type of swimming pool especially for pools already built. It is designed for supplementary mounting and is equipped with reduction and connection to vacuum cleaners with DN 32 mm hose.

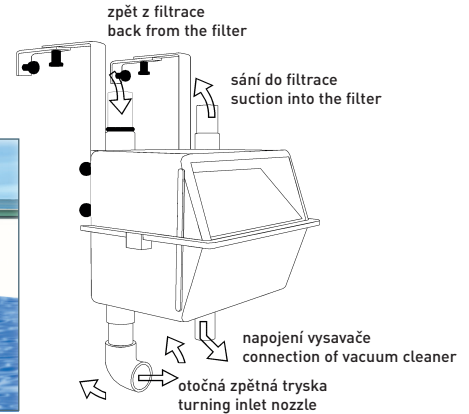
**Závěsný skimmer | Wall-mounted skimmer**

Závěsný skimmer   Wall-mounted skimmer				cena Kč	€
10031	B Závěsný skimmer Wall-mounted skimmer		1	2,60	5 342,-

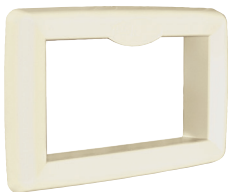

1020



10200



102005 - RAL 7037



10300



112005 - RAL 7037



11200



152001



152002



E103005



1021

**Příslušenství skimmeru V20 | Skimmer accessories V20**

Příslušenství skimmeru V20   Skimmer accessories V20				cena Kč	€
1020	B Clonka skimmeru ABS, kryt příruby skimmeru Skimmer shield ABS, flange shield		1	0,30	818,-
10200	B Clonka skimmeru nerez, kryt příruby skimmeru Skimmer shield stainless steel, flange shield		1	0,90	5 285,-
10201	B Clonka skimmeru MTS, nerez - prodloužené hrdlo Skimmer shield MTS, stainless steel - extended throat		1	0,30	7 829,-
102005	B Clonka skimmeru šedá, kryt příruby skimmeru, RAL7037 Skimmer shield grey, flange shield, RAL7037		1	0,90	834,-
1021	B Vakuový kotouč - pro napojení vysavače do skimmeru Skim vac - vacuum cleaner connection		1	0,27	1 355,-
10300	B Víko skimmeru nerez Top cover stainless steel		1	0,30	1 065,-
11200	B Prodloužení vtoku skimmeru pro 50 mm, ABS Skimmer neck extension for 50 mm extension, ABS		1	0,30	918,-
112005	B Prodloužení vtoku skimmeru pro 50 mm, šedá, RAL7037 Skimmer neck extension for 50 mm extension, grey, RAL7037		1	0,30	941,-
152001	B Přírubová jednotka ABS skimmeru V20 pro přestavbu skimmeru 1024 na 15241 ABS flange unit for skimmer V20 to change from 1024 to 15241		1	0,60	2 125,-
152002	B Přírubová jednotka nerez skimmeru V20 pro přestavbu skimmeru 1024 na 15241 nerez Stainless steel flange unit for skim. V20 to change from 1024 to 15241 stainless steel		1	0,90	5 768,-
E103005	B Koš skimmeru - k zachycení hrubých nečistot Skimmer basket - for debris		1	0,09	596,-
1531	B Šikmé prodloužení hrdla skimmeru Neck extension - slanted		1	0,85	3 832,-



1024 (RAL 9003)



15241



10248 (RAL 7037)



152415

**Skimmer V20**

- Napojení: Ø 50 mm, 63 mm
- Napojení přepadu: Ø 32 mm
- Horizontální prodloužení: ne
- Vertikální prodloužení: ne
- Vakuový kotouč: ne
- Mosazné zástrčky M6 (15241, 152415)
- Materiál: ABS

**Skimmer V20**

- Connection: Ø 50 mm, 63 mm
- Overflow connection: Ø 32 mm
- Horizontal extension: no
- Vertical extension: no
- Skim vac: no
- Brass inserts M6 (15241, 152415)
- Material: ABS

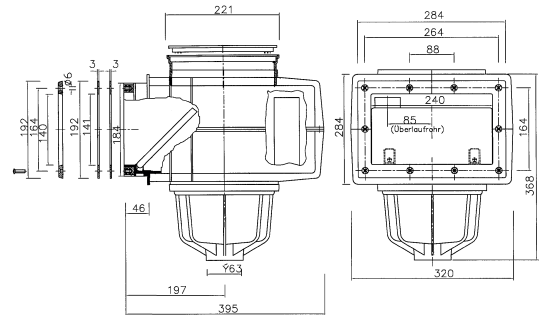
**Skimmer V20 ABS | Skimmer V20 ABS**

					cena Kč	€
1024	B	Skimmer V20 ABS do betonu, 200 x 150 mm – bílý, RAL 9003 Skimmer V20 ABS for concrete, 200 x 150 mm – white, RAL 9003		1	4,50	7 151,-
10248	B	Skimmer V20 ABS do betonu, 200 x 150 mm – šedý, RAL 7037 Skimmer V20 ABS for concrete, 200 x 150 mm, – grey, RAL 7037		1	4,50	7 634,-
15241	B	Skimmer V20 ABS pro fólie, 200 x 150 mm, s mosaznými zástrčky M6 – bílý, RAL 9003 Skimmer V20 ABS for liners, 200 x 150 mm, with brass inserts M6 – white, RAL 9003		1	5,50	8 064,-
152415	B	Skimmer V20 ABS pro fólie, 200 x 150 mm, s mosaznými zástrčky M6 – šedý, RAL 7037 Skimmer V20 ABS for liners, 200 x 150 mm, with brass inserts M6 – grey, RAL 7037		1	5,50	8 211,-

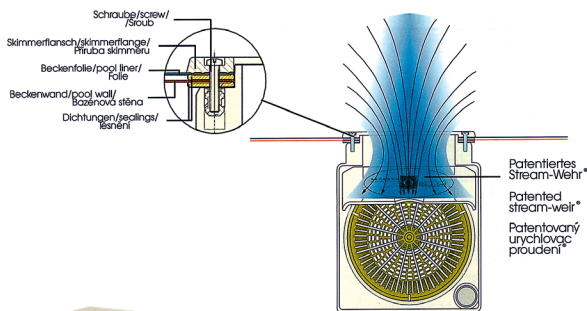

1513



10132

**Skimmer V10**

- S kapacitou „širokého skimmeru“
- Napojení: Ø 50 mm, 63 mm
- Napojení přepadu: Ø 32 mm
- Horizontální prodloužení: ne
- Vertikální prodloužení: ne
- Vakuový kotouč: ne
- Mosazné zástrčky M6
- Materiál: ABS

**Skimmer V10**

- Capacity of a wide skimmer
- Connection: Ø 50 mm, 63 mm
- Overflow connection: Ø 32 mm
- Horizontal extension: no
- Vertical extension: no
- Skim vac: no
- Brass inserts M6
- Material: ABS

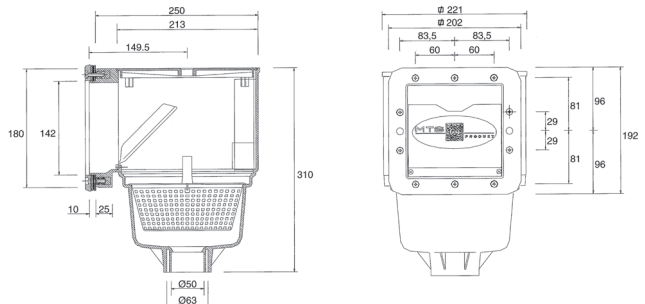
**Skimmer V10 ABS | Skimmer V10 ABS**

					cena Kč	€
1513	B	Skimmer V10 ABS pro fólie, 150 x 150 mm, s mosaznými zástrčky, napojení 50, 63 mm Skimmer V10 ABS for liners, 150 x 150 mm, with brass inserts, connection 50, 63 mm		1	4,00	4 550,-
10132	B	Clonka skimmeru, kryt příruby skimmeru Skimmer shield, flange shield		1	0,90	565,-

**Skimmery VA**

jsou vyrobeny z bílého ABS, odolného proti UV záření. Výhodou jsou mosazné zástříky M6 pro lepší dotažení příruby. U některých typů skimmerů je prodloužená délka hrdla pro bazény s bazénovým lemem. Vakuový kotouč je součástí. Výšku je možno prodloužit vertikálním prodloužením.



154041001

NEREZ / STAINLESS STEEL

Prodloužené hrdlo / Extended neck

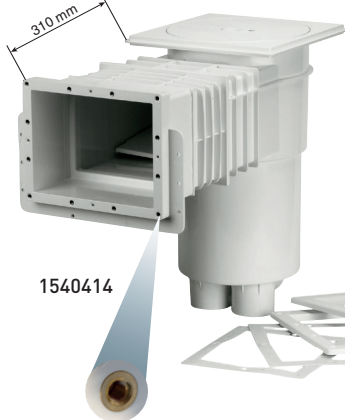

1540414

s mosaznými zástříky  
with brass inserts

IE016

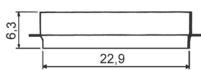

1540411

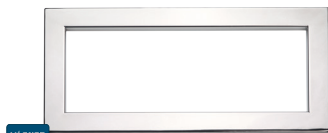

NEREZ / STAINLESS STEEL 154041101

**Skimmers VA**

made of white ABS, UV-resistant. The brass M6 inserts are an advantage for better flange tightening. Some types of skimmers have extended neck for pools with hem. The skimmer height can be extended with vertical extensions. Skim Vac included.

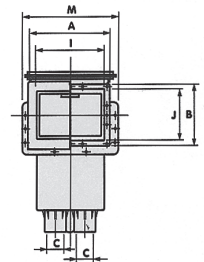
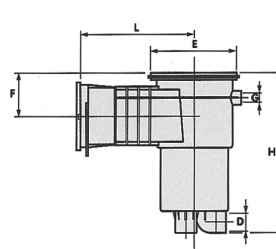

	A	B	C	D	E	F	G	H	I	J	L	M
1540410	246	193	2"	63	266	114	32	480	215	160	349	298
1540414	246	193	2"	63	266	114	32	480	215	160	443	298
1540411	440	193	2"	63	266	114	32	480	406	160	443	492

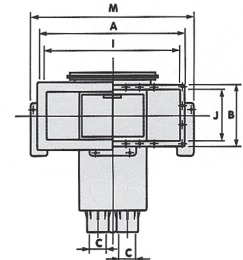
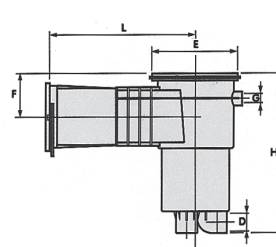
**Technická data**

- Napojení: Ø 63 mm, 2"
- Napojení přepadu: Ø 32 mm
- Napojení dopouštění: ano
- Horizontální prodloužení: ne
- Vertikální prodloužení: ano
- Doporučený průtok: 4–12 m<sup>3</sup>/h
- Vakuový kotouč: ano
- Mosazné zástříky M6
- 1540414 – prodloužené hrdlo

**Technical data**

- Connection: Ø 63 mm, 2"
- Overflow connection: Ø 32 mm
- Connection of refilling: yes
- Horizontal extension: no
- Vertical extension: yes
- Recomm. flow rate: 4–12 m<sup>3</sup>/h
- Skim vac: yes
- Brass inserts M6
- 1540414 – extended neck

Skimmer VA   Skimmer VA			KG	cena Kč	€	
1540410	B	Skimmer VA, sání 215 mm x 160 mm, pro fólie, s mosaznými zástříky Skimmer VA, suction 215 mm x 160 mm, for liner, with brass inserts		1	5,00	3 060,-
1540414	B	Skimmer VA, sání 215 mm x 160 mm, pro fólie, prodloužené hrdlo, s mosaznými zástříky Skimmer VA, suction 215 mm x 160 mm, for liner, longer extension, with brass inserts		1	6,00	3 468,-
1540411	B	Skimmer VA, sání 406 mm x 160 mm, pro fólie, s mosaznými zástříky Skimmer VA, suction 406 mm x 160 mm, for liner, with brass inserts		1	6,00	3 096,-
IE016	B	Prodloužení čistící části (vertikální) pro skimmery VA Vertical extension for skimmer VA		1	0,20	286,-
154041001	B	Nerez rámeček pro skimmery VA, sání 215 mm x 160 mm (1540410 a 1540414) Stainless steel frame for skimmers VA, suction 215 mm x 160 mm (1540410 and 1540414)		1	0,50	5 739,-
154041101	B	Nerez rámeček pro skimmery VA, sání 406 mm x 160 mm (1540411) Stainless steel frame for skimmers VA, suction 406 mm x 160 mm (1540411)		1	0,90	6 540,-

**Skimmery 17,5 l**

je vyroben z bílého ABS, odolného proti UV záření a má mosazné zástřiky, čtvercové víko, připojení 2".



15411309

15411309

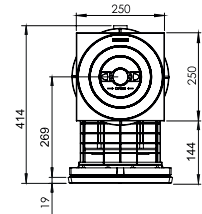
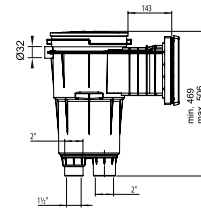
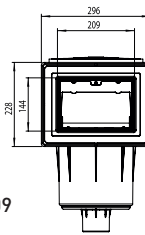

15411310

15411310

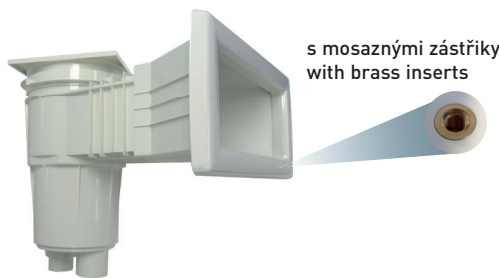
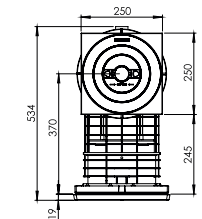
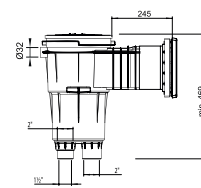
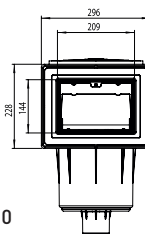

15411311

15411311

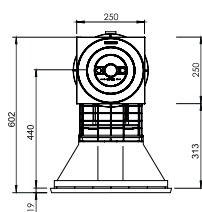
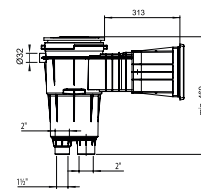
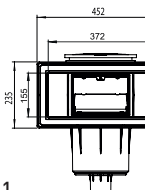
**Technická data**

- Napojení: Ø 63 mm, 2"
- Napojení přepadu: Ø 32 mm
- Napojení dopouštění: ano
- Horizontální prodloužení: ne
- Vertikální prodloužení: ne
- Doporučený průtok: 4–12 m<sup>3</sup>/h
- Vakuový kotouč: ano
- Mosazné zástřiky M6

**Technical data**

- Connection: Ø 63 mm, 2"
- Overflow connection: Ø 32 mm
- Connection of refilling: yes
- Horizontal extension: no
- Vertical extension: no
- Recomm. flow rate: 4–12 m<sup>3</sup>/h
- Skim vac: yes
- Brass inserts M6

Skimmer 17,5 l   Skimmer 17,5 l				cena Kč	€
15411309	B Skimmer 17,5 l, pro fólie, s mosaznými zástřiky, standardní hrdlo Skimmer 17,5 l, for liner, with brass inserts, standard throat		1	5,00	3 462,-
15411310	B Skimmer 17,5 l, pro fólie, s mosaznými zástřiky, standardní hrdlo – prodloužené Skimmer 17,5 l, for liner, with brass inserts, standard throat – extended		1	6,50	3 981,-
15411311	B Skimmer 17,5 l, pro fólie, s mosaznými zástřiky, široké hrdlo Skimmer 17,5 l, for liner, with brass inserts, wide throat		1	6,00	4 136,-

**Skimmery 17,5 l s úkosem 6°**

určené pro předvyrobené a fóliové bazény se šikmou stěnou.

**Skimmers 17,5 l with adjustable angle 6°**

for use with prefabricated and liner pools with an inclined wall.

Skimmer 17,5 l s úkosem 6°   Skimmer 17,5 l with adjustable angle 6°				cena Kč	€
15435664	B Skimmer 17,5 l s úkosem 6°, pro fólie, s mosaznými zástřiky, standardní hrdlo Skimmer 17,5 l with adj. angle 6°, for liner, with brass inserts, standard throat		1	5,00	4 612,-
15435665	B Skimmer 17,5 l s úkosem 6°, pro fólie, s mosaznými zástřiky, široké hrdlo Skimmer 17,5 l with adj. angle 6°, for liner, with brass inserts, wide throat		1	5,00	4 938,-



1540400

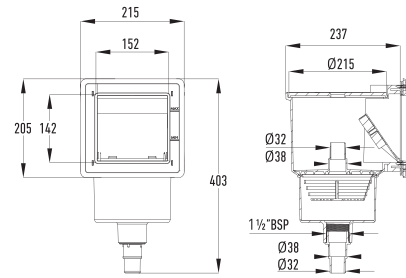

## Skimmer VA | Skimmer VA



cena Kč



1540400

B

Skimmer VA 150 x 150 mm, s clonkou šroubů, pro fólie, připojení 1 1/2"  
 Skimmer VA 150 x 150 mm, with screws screen, for liner, connection 1 1/2"



1

1,00

885,-

## Skimmery Hayward (Kripsol)

do betonu nebo fólie jsou vyrobeny z bílého vstříkovaného ABS. Tento materiál nepodléhá změněm v důsledku vystavení chemickým ani atmosferickým vlivům. Kulaté víko upevněné na čtvercový rám. Dvířka sání se závěsy upevněny pomocí snadno vyměnitelných osiček z ABS. Vakuový kotouč je součástí.

## Hayward (Kripsol) skimmers

for concrete or liner made of white injected ABS. This material cannot be affected by chemical and atmospheric agents. Round lid mounted on a square rim. Skimmer weir hinged with easily replaceable ABS pins. Skim vac included.



1540405

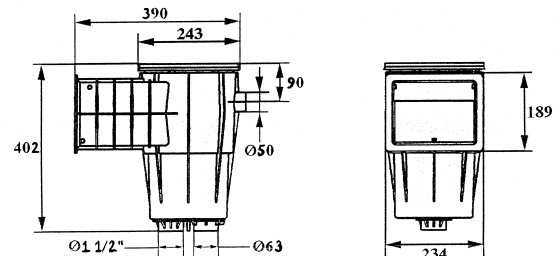

## Technická data

- Napojení: Ø 63 mm, 1 1/2"
- Napojení přepadu: Ø 50 mm
- Napojení dopouštění: ano
- Horizontální prodloužení: ne
- Vertikální prodloužení: ano
- Doporučený průtok: 4–12 m<sup>3</sup>/h
- Vakuový kotouč: ano
- Samořezné šrouby příruby

## Technical data

- Connection: Ø 63 mm, 1 1/2"
- Overflow connection: Ø 50 mm
- Connection of refilling: yes
- Horizontal extension: no
- Vertical extension: yes
- Recomm. flow rate: 4–12 m<sup>3</sup>/h
- Skim vac: yes
- Self-drilling screw of the flange

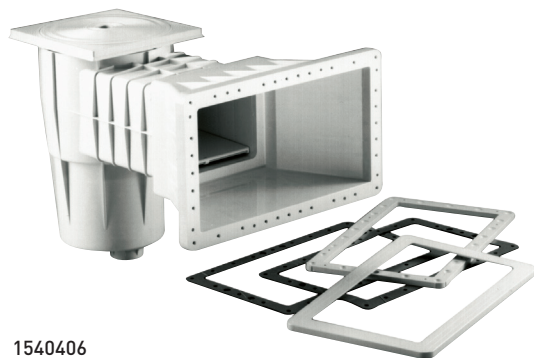

1540406

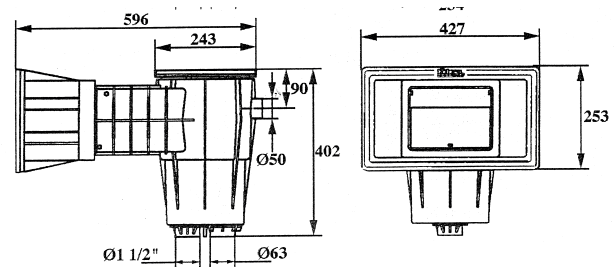

Vertikální prodloužení pro skimmer Hayward (Kripsol)  
 Vertical extension for Hayward (Kripsol) skimmers



10404051

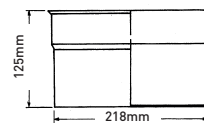

## Skimmer Hayward (Kripsol) | Skimmer Hayward (Kripsol)



cena Kč



1540405

B

Skimmer Hayward (Kripsol) sání 200 mm x 180 mm, pro fólie, kompletní s vak. kotoučem  
 Skimmer Hayward (Kripsol) suction 200 mm x 180 mm, for liner, complete with Skim Vac



1

3,20

2 116,-

1540406

B

Skimmer Hayward (Kripsol) sání 400 mm x 230 mm, pro fólie, kompletní s vak. kotoučem  
 Skimmer Hayward (Kripsol) suction 400 mm x 230 mm, for liner, complete with Skim Vac



1

5,10

2 943,-

10404051

B

Prodloužení čistící části (vertikální) pro skimmery Hayward (Kripsol)  
 Vertical extension for Hayward (Kripsol) skimmers



1

0,80

204,-

## Superskimmer 17,5 l



## Superskimmer 17,5 l

## Technická data

- Vyroben z plastu ABS odolného proti UV záření
- Mosazné zástřiky
- Čtvercové víko
- Připojení 2"
- Horizontální prodloužení: ne
- Vertikální prodloužení: ne

## Technical data

- Made of UV-resistant ABS
- Brass inserts
- Square top cover
- Connection 2"
- Horizontal extension: no
- Vertical extension: no

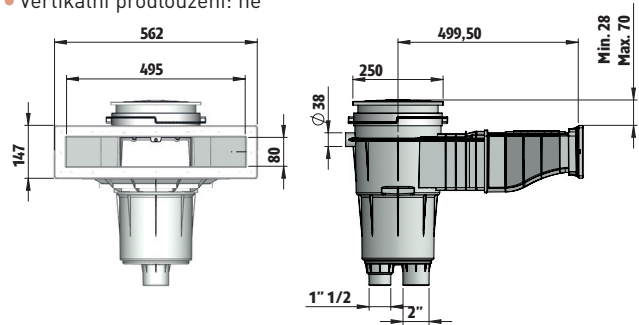

NEREZ / STAINLESS STEEL 1541120101

Superskimmer 17,5 l   Superskimmer 17,5 l					cena Kč	€
15411201	B	Superskimmer 17,5 l, pro fólie, s mosaznými zástřiky, nízké široké hrdlo Superskimmer 17,5 l, for liner, with brass inserts, small wide throat		1	5,60	4 041,-
154112114	B	Superskimmer 17,5 l, pro fólie, s mosaznými zástřiky, nízké široké hrdlo, RAL 7004 – sv. šedá Superskimmer 17,5 l, for liner, with brass inserts, low wide throat, RAL 7004 – light grey		1	5,60	5 335,-
154112115	B	Superskimmer 17,5 l, pro fólie, s mosaznými zástřiky, nízké široké hrdlo, RAL 7016 – tm. šedá Superskimmer 17,5 l, for liner, with brass inserts, small wide throat, RAL 7016 – dark grey		1	5,60	5 335,-
1541120101	B	Nerez rámeček pro Superskimmer 17,5 l Stainless steel frame for Superskimmer 17,5 l		1	0,90	6 500,-

## Skimmer Juming

- Celonerezový skimmer AISI 316L
- Široké hrdlo
- Leštěný rámeček

## Juming skimmer

- Stainless steel skimmer AISI 316L
- Wide mouth
- Polished front

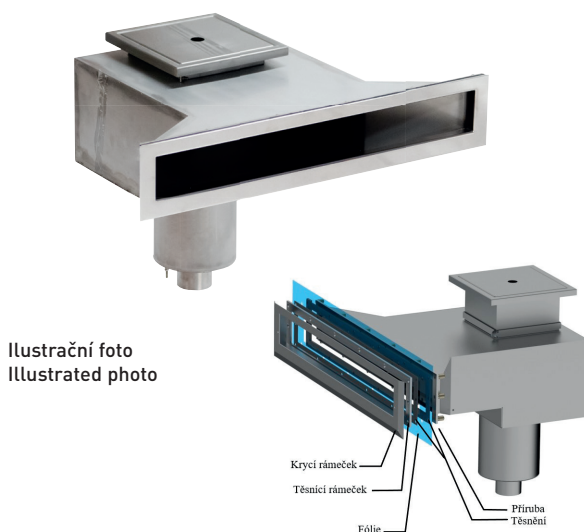
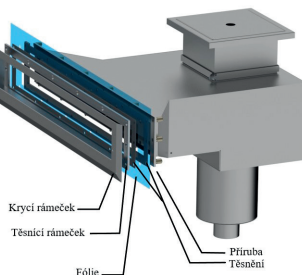
Ilustrační foto  
Illustrated photo

## Technická data

- Max. doporučený průtok: 15 m<sup>3</sup>/h
- Horizontální prodloužení: ne
- Vertikální prodloužení: ne

## Technical data

- Max. flow capacity: 15 m<sup>3</sup>/h
- Horizontal extension: no
- Vertical extension: no

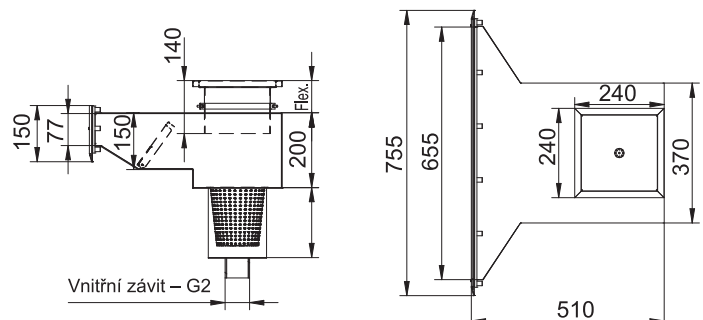

Skimmer Juming   Skimmer Juming					cena Kč	€
1542200	B	Skimmer JUMING, pro fóliové bazény – nerez, široké hrdlo Skimmer JUMING, for liner pools – stainless steel, wide mouth		1	24	43 132,-

### Skimmery Hayward

jsou vyrobeny z bílého ABS. Výšku je možno nastavit vertikálním prodloužením. Vakuový kotouč není součástí.





HSP1085



HSP1084

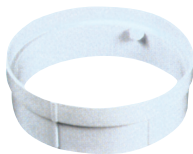

HSP1106



HSP1084P1

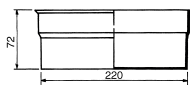

### Hayward skimmers

for concrete or liner made of white injected ABS. The skimmer height can be extended with vertical extensions. Skim Vac not included.

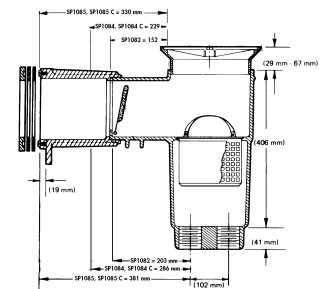
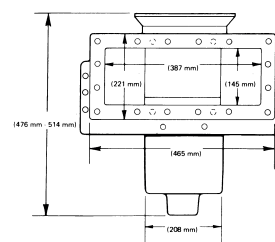
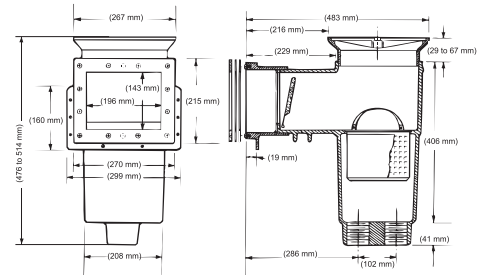







#### Technická data

- Napojení: Ø 63 mm, 2"
- Napojení přepadu: Ø 32 mm
- Napojení dopouštění: ano
- Horizontální prodloužení: ne
- Vertikální prodloužení: ano
- Doporučený průtok: 4–12 m<sup>3</sup>/h
- Samořezné šrouby příruby

#### Technical data

- Connection: Ø 63 mm, 2"
- Overflow connection: Ø 32 mm
- Connection of refilling: yes
- Horizontal extension: no
- Vertical extension: yes
- Recom. flow rate: 4–12 m<sup>3</sup>/h
- Self-drilling screws of the flange





Skimmer Hayward   Skimmer Hayward					cena Kč	€
HSP1084	B	Skimmer Hayward, sání 200 mm x 150 mm, pro fólie, bez vakuového kotouče Skimmer Hayward, suction 200 mm x 150 mm, for liner, without Skim Vac		1	6,00	6 068,-
HSP1085	B	Skimmer Hayward, sání 400 mm x 200 mm, pro fólie, bez vakuového kotouče Skimmer Hayward, suction 400 mm x 200 mm, for liner, without Skim Vac		1	6,00	7 064,-
HSP1106	B	Vakuový kotouč Skim Vac Hayward – pro napojení vysavačové hadice Skim Vac Hayward – to connect vacuum cleaner hose		1	0,15	786,-
HSP1084P1	B	Prodloužení čistící části skimmeru Hayward 400 mm x 200 mm Vertical extension for skimmer Hayward 400 mm x 200 mm		1	0,20	586,-

Filtrační punčocha je vhodná pro všechny druhy košíčků do skimmerů.



Large nylon filtration sack can be used in all skimmer baskets.



Filtrační punčocha   Large nylon filter					cena Kč	€
698001	C	Filtrační punčocha do košíčku skimmerů 5 ks/bal. Large nylon filter sock for Skimmer basket 5 pcs		100	0,05	231,-
698002	C	Filtrační punčocha do košíčku skimmerů 12 ks/bal. Large nylon filter sock for skimmer basket 12 pcs		36	0,10	461,-



**Skimmery Premium**

jsou vyrobeny z bílého ABS. Výšku je možno nastavit vertikálním prodloužením. U typu 1543111 je možno prodloužit délku sání horizontálním prodloužením. **Vakuový kotouč není součástí.**



1543111

Horizontální prodloužení pro skimmer  
Horizontal extension for skimmer

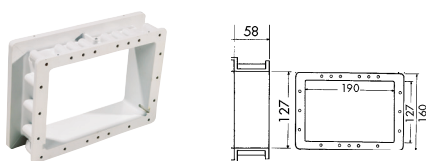

1040405011

Vertikální prodloužení pro skimmer  
Vertical extension for skimmers

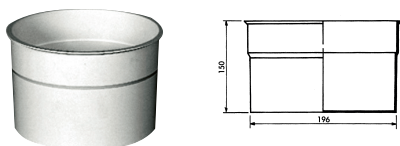

1040405012

**Vakuový kotouč** umožňuje připojení vysavačové hadice ke skimmeru, pokud není instalována sací tryska.

**Skim Vac** allows connection of suction pipe to skimmer if there is no vacuum nozzle fitting.

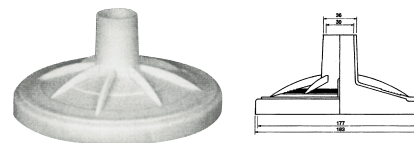

1043190

**Skimmers Premium**

for concrete or liner made of white injected ABS. Height can be adjusted by means of vertical extension. On type 1543111 the height can be extended with vertical extensions. **Skim Vac not included.**

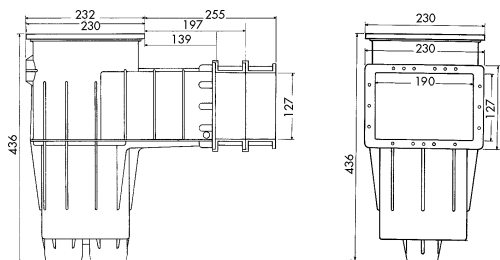
**Technická data**

- Napojení: Ø 63 mm, 2"
- Napojení přepadu: Ø 32 mm
- Napojení dopouštění: ano
- Horizontální prodloužení: ano
- Vertikální prodloužení: ano
- Doporučený průtok: 4–12 m<sup>3</sup>/h
- Samořezné šrouby příruby

**Technical data**

- Connection: Ø 63 mm, 2"
- Overflow connection: Ø 32 mm
- Connection of refilling: yes
- Horizontal extension: yes
- Vertical extension: yes
- Recom. flow rate: 4–12 m<sup>3</sup>/h
- Self-drilling screws of the flange

Skimmer Premium   Skimmer Premium					cena Kč	€
1543111	B	Skimmer Premium sání 200 mm x 150 mm, pro fólii, bez vakuového kotouču Skimmer Premium suction 200 mm x 150 mm, for liner, without Skim Vac		1	3,20	3 256,-
1043190	B	Vakuový kotouč Skim Vac Premium – pro napojení vysavačové hadice Skim Vac Premium – to connect vacuum cleaner hose		1	0,20	355,-
1040405012	B	Prodloužení čistící části 3195 (vertikální) pro skimmery Premium, Design Vertical extension 3195 for Premium, Design skimmers		1	0,40	337,-
1040405011	B	Prodloužení vtokové části SK16001VE (horizontální) pro skimmer Premium 200 x 150 mm Horizontal neck extension SK1600VE for Premium skimmer 200 x 150 mm		1	0,20	598,-

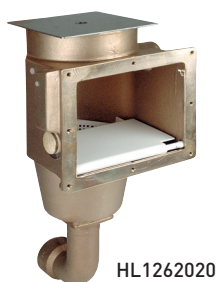

HL1262020

**AllFit**  
a brand of Hugo Lahme GmbH  
**HUGO LAHME**  
GmbH



HL1620020

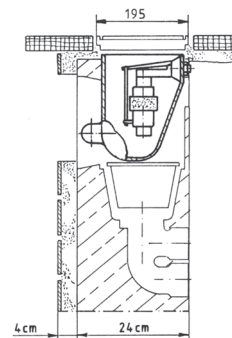
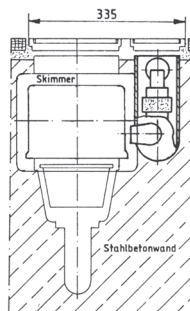

Skimmer Hugo Lahme   Skimmer Hugo Lahme					cena Kč	€
HL1262020	D	Skimmer 240 mm, napojení 2" int., hloubka 240 mm, výška 200 mm, šířka 300 mm Skimmer 240 mm, connection 2" int., depth 240 mm, height 200 mm, width 300 mm		1	6,00	23 429,-
HL1620020	D	Mechanické dopouštění vody pro skimmer 1262020 Mechanical water level controller for skimmer 1262020		1	3,00	9 947,-

**Elektronické hlídání hladiny**

Elektronické automatické hlídání hladiny pro dopouštění vody se sondami + elektromagnetické ventily ½", ¾", 1".  
Možno nainstalovat do skimmeru.



201524020

**Electronic water level controller**

Electronic automatic control of water level for refilling system with probes + electromagnetic valves ½", ¾", 1".  
Can be installed into the skimmer.



201524122

Elektronické hlídání hladiny   Electronic water level controller					cena Kč	€	
201524021	B	Elektronické automatické hlídání hladiny v rozvaděči + 3x sonda Electronic automatic water level controller in junction box + 3x probe			1	0,80	3 962,-
201524020	B	Elektronické automatické hlídání hladiny + 3x sonda (modul na DIN lištu) Electronic automatic water level controller + 3x probe (module for DIN ledge)			1	0,35	2 546,-
201524122	B	Elektromagnetický ventil ½", (230 V) Electromagnetic valve ½", (230 V)			1	0,45	3 036,-
201524123	B	Elektromagnetický ventil ¾", (230 V) Electromagnetic valve ¾", (230 V)			1	0,85	4 298,-
201524124	B	Elektromagnetický ventil 1", (230 V) Electromagnetic valve 1", (230 V)			1	1,20	5 006,-

**Hlídání hladiny v akumulčních jímkách**

Zařízení je vybaveno sedmi hladinovými čidly, která hlídají havarijní minimální hladinu, ovládá dopouštění vody od nastavené minimální hladiny do nastavené výšky a hlídá maximální hladinu.

**Water level control in balance tanks**

This equipment contains 7 sensors for management of minimum, optimal and maximum water levels. Controls water filling to a preset level, monitors maximum water level.



201524023

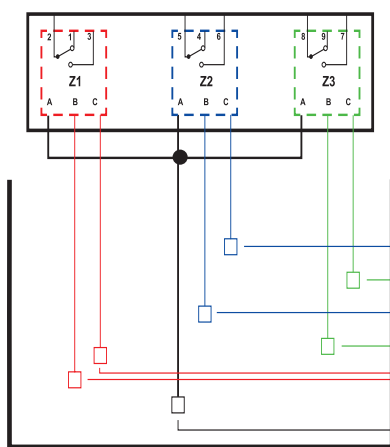

201524022

**Schéma hlídání tří hladin v akumulční nádrži****Z1** Minimální hladina**Z2** Chod čerpadla filtrace**Z3** Dopouštění vody**Minimum level****Operation of filtration pump****Water refilling**

K připojení sond použijte vodič CYA 1,5 mm

Use a CYA 1,5 mm conductor for sensor connection

Hladina vody pro sepnutí čerpadla filtrace

Water level – turning on the filtration pump

Hladina vody pro vypnutí dopouštění vody

Water level – turning off the water refill

Hladina vody pro vypnutí čerpadla filtrace

Water level – turning off the filtration pump

Hladina vody pro sepnutí dopouštění vody

Water level – turning on the water refill

2x havarijní hladina vody v nádrži

2x Emergency water level in a tank

Referenční sonda (musí být stále pod vodou)

Reference sensor (must be submerged in water all the time)

Elektronické hlídání hladiny   Electronic water level control					cena Kč	€	
201524022	B	Elektronické hlídání hladiny v akumulční jímce + 7x sonda – automatika v rozvaděči Balance tank electronic water level control – 7 sensors – wall box			1	1,40	8 229,-
201524023	B	Elektronické hlídání hladiny v akumulční jímce + 7x sonda, modul na DIN lištu Balance tank electronic water level control – 7 sensors – module for DIN ledge			1	0,65	6 996,-
201524019	B	Samostatná sonda pro určení hladiny Water level sensor – separate			1	0,03	345,-

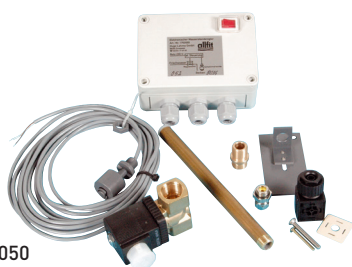

HL1702050



Hlídání hladiny Hugo Lahme   Water level control Hugo Lahme					cena Kč	€
HL1702050	D	Elektronické dopouštění vody – s el. mag. ventilem pro skimmer 1262020 Electric water level controller – with electromagnetic valve for skimmer 1262020		1	0,30	17 503,-

**Mini – hladinový ventil**

Mechanický regulátor vodní hladiny je vhodný zejména pro použití do skimmerů a to především do skimmerů MTS V20 a VS30, nebo do nádrží s kapalinou. Je vybaven nastavitelným plovákem.

- Napojení 1/2" ext. nebo 20 mm



2021



**Mini – water level valve**

Water level controller is particularly suitable to use in skimmers – especially skimmers MTS V20 and VS30 or in tanks with fluid. The controller is equipped with an adjustable float.

- Connection 1/2" ext. or 20 mm

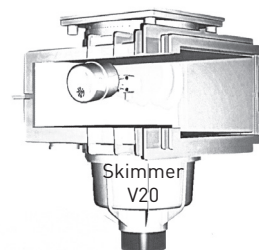
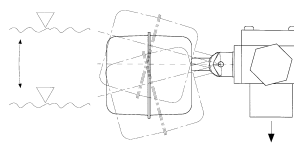

Mini – hladinový ventil   Mini – water level valve					cena Kč	€
2021	B	Mini – hladinový ventil – R 1/2" Mini – water level valve – R 1/2"		30	0,15	1 609,-

**Dopouštění vody**

v jímce spojené s hladinou vody – plovákový dopouštěcí systém. Nejlepší systém a způsob jak udržovat optimální hladinu vody v bazénu, protože regulátor automaticky doplní vodu a tím srovná ztráty, které vzniknou při filtrování, odpařování atd.

- Napojení 50 mm
- Připojení dopouštění 3/8" ext.



2015240



2015862

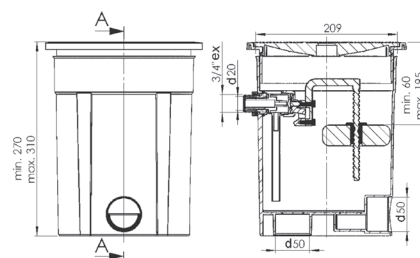

**Water level controller**

In-tank floater refilling system. The best system to maintain the optimal water level and replace water losses due to filter washing, evaporation, etc.

- Connection 50 mm
- Connection of water refilling 3/8" ext.

Dopouštění vody   Water level controller					cena Kč	€
2015240	B	Dopouštění vody v jímce spojené s hladinou vody Water level controller, combined water level and pool water control in the tank		1	6,00	1 572,-
2015862	B	Dopouštění vody v jímce spojené s hladinou vody – nastavitelné Water level controller, combined water level and pool water control in the tank – adjustable		1	0,25	1 985,-

### Podlahové výpusti

Veškeré dnové výpusti jsou vyrobeny z ABS a liší se designem krytu, který je z nerez. ocel. plechu. Dnové výpusti se dělí dle typu, pro betonové nebo fóliové, popř. jiné bazény. Připojení: R 2" x 2 1/2", 63 mm připojení lepením. Směr odtoku je 90° a 180°.

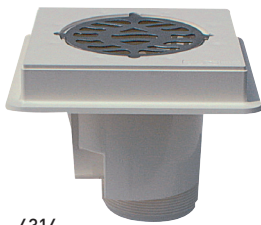

4314

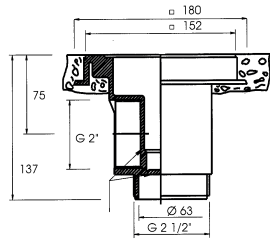

### Main drains

All types of main drains are made of ABS and vary with casing design. The casing material is a stainless steel sheet. Main drains are available for concrete, liner or other pools. Connection with glue: R 2" x 2 1/2", 63 mm. Outflow in 90° and 180°.



4324

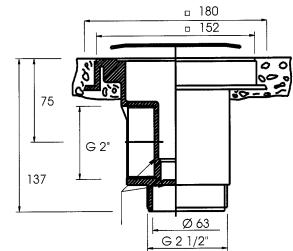

4814

s mosaznými zástříky  
with brass inserts

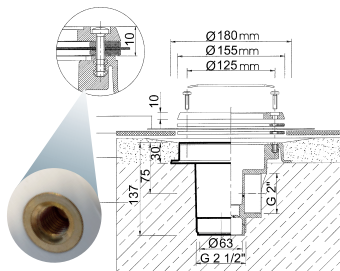

4824

s mosaznými zástříky  
with brass inserts

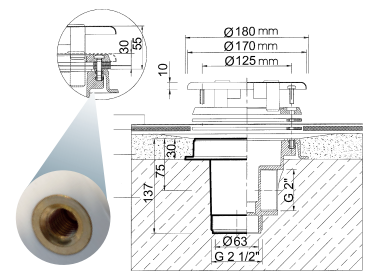

Podlahová výpust   Main drain		📦	KG	cena Kč	€
4314	B	Podlahová výpust ABS, nerez mřížka AISI 316 – pro betonové bazény, napojení 2" int. Main drain ABS, stainless grating AISI 316 – for concrete pools, connection 2" int.	12	0,70	1 679,-
4324	B	Podlahová výpust ABS, nerez kryt čtvercový AISI 316 – pro betonové bazény, napojení 2" int. Main drain ABS, stainless square shape casing AISI 316 – for concrete pools, connection 2" int.	12	0,95	2 404,-
4814	B	Podlahová výpust ABS, nerez mřížka AISI 316 – pro fóliové bazény, napojení 2" int. Main drain ABS, stainless grating AISI 316 – for liner pools, connection 2" int.	12	0,94	2 602,-
4824	B	Podlahová výpust ABS, nerez kryt čtvercový AISI 316 – pro fóliové bazény, napojení 2" int. Main drain ABS, stainless square shape casing AISI 316 – for liner pools, connection 2" int.	12	1,20	3 541,-

### Podlahová výpust VAMILA

- Mřížka nerez AISI 316
- Tělo ABS
- Maximální průtok: 11 m<sup>3</sup>/h

### Main drain VAMILA

- Grating stainless steel AISI 316
- Body ABS
- Maximum flow rate: 11 m<sup>3</sup>/h

VAGNER  
POOL

AISI 316  
STAINLESS STEEL  
NEREZ

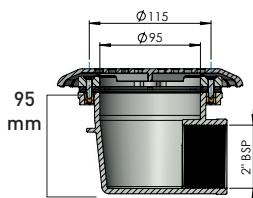

4827814 s mosaznými zástříky  
4827814 with brass inserts



4827814



4800273



4800275

Podlahová výpust VAMILA NEREZ   Main drain stainless steel VAMILA		📦	KG	cena Kč	€
4827814	B	Podlahová výpust VA, pro fólii, mosazné zástříky M6, napojení 2" int., malá Main drain VA, for liner pools, brass inserts M6, connection 2" int., small	1	0,20	1 017,-
4800273	B	Podlahová výpust VAMILA nerez, napojení 2", mosazné zástříky Main drain VAMILA stainless steel, connection 2", with brass inserts	1	1,20	3 634,-
4800275	B	Podlahová výpust VAMILA nerez, napojení 2", mosazné zástříky – jemná mřížka Main drain VAMILA stainless steel, connection 2", with brass inserts – fine grating	1	1,20	4 005,-

**Podlahová výpust VA**

- Mřížka nerez AISI 316
- Tělo ABS
- Maximální průtok: 13 m³/h

**Main drain VA**

- Grating st. steel AISI 316
- Body ABS
- Maximum flow rate: 13 m³/h

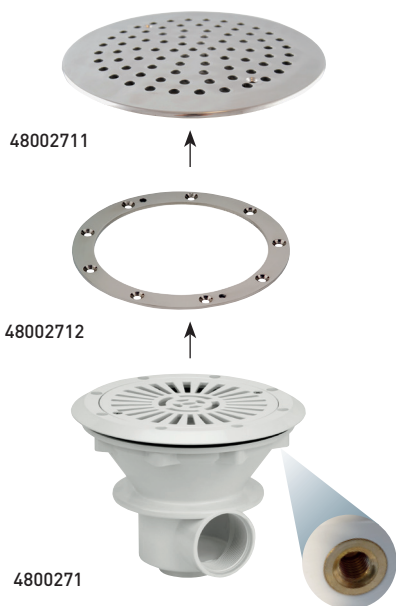

4800276

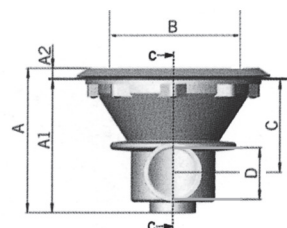

A A1 A2 ØB C D  
171 158 13 229 110 2"

4800271 s mosaznými zástrčky  
4800271 with brass inserts

Podlahová výpust VA   Main drain VA				KG	cena Kč	€
4800271	B	Podlahová výpust VA, pro fólii, <b>mosazné zástrčky M6</b> , napojení 2" int. Main drain VA, for liner pools, <b>brass inserts M6</b> , connection 2" int.		4	0,60	1 177,-
4800276	B	Podlahová výpust VA nerez, pro fólii, <b>mosazné zástrčky M6</b> , napojení 2" int. Main drain VA stainless steel, for liner pools, <b>brass inserts M6</b> , connection 2" int.		4	1,25	4 570,-
48002711	B	Mřížka nerez pro podlahovou výpust VA nerez Stainless steel grating for main drain VA stainless steel		1	0,35	2 304,-
48002712	B	Příruba nerez pro podlahovou výpust VA nerez Stainless steel flange for main drain VA stainless steel		1	0,30	1 232,-

**Podlahová výpust Hayward**

Podlahovou výpust Hayward je možno dovybavit nerezovou přírubou a nerezovou mřížkou.

**Main drain Hayward**

The main drain Hayward can be equipped with stainless steel flange and grating.

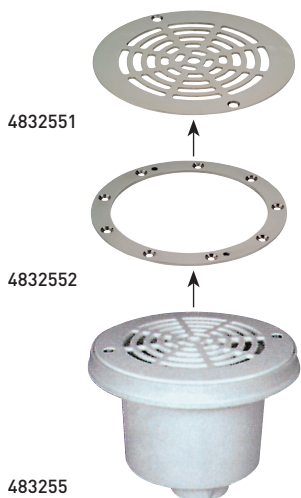

483256

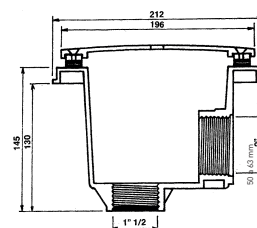

Podlahová výpust Hayward   Main drain Hayward				KG	cena Kč	€
483255	B	Podlahová výpust pro fólii, napojení lepením 50/63 mm, sání 5–15 m³/h Main drain for liner pools, adhesive connection 50/63 mm, suction 5–15 m³/h		1	0,60	1 108,-
483256	B	Podlahová výpust pro fólii, nerez, napojení lepením 50/63 mm, sání 5–15 m³/h Main drain for liner pools, stainless steel, connection to glue 50/63 mm, suction 5–15 m³/h		1	1,25	4 543,-
4832551	B	Mřížka nerez pro podlahovou výpust Hayward 483255 Stainless steel grating for main drain Hayward 483255		1	0,35	1 732,-
4832552	B	Příruba nerez pro podlahovou výpust Hayward 483255 Stainless steel flange for main drain Hayward 483255		1	0,30	1 596,-

### Podlahová výpust – kulatá

- Vyrobeno z nerezové oceli AISI316
- Rozměr: Ø 215 mm
- Napojení: 2" Int.

**VAGNER**  
POOL



480011

**AISI 316**  
STAINLESS STEEL  
NEREZ

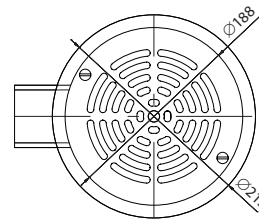
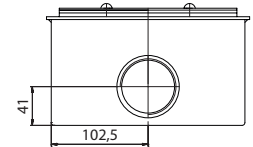
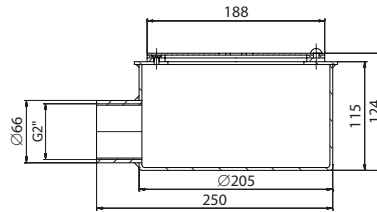

### Main drain – round

- Made of stainless steel AISI316
- Dimensions: Ø 215 mm
- Connection: 2" Int.

Podlahová výpust nerez   Main drain stainless steel					cena Kč	€		
480011	B	Podlahová výpust nerez kulatá s přírubou pro fólii, napojení 2" int. Main drain stainless steel round with flange for liner, connection 2" int.			1	2,50	10 314,-	
430011	B	Podlahová výpust nerez kulatá do betonu, napojení 2" int. Main drain stainless steel round for concrete, connection 2" int.			1	2,50	10 314,-	

### Podlahová výpust – čtvercová

- Vyrobeno z nerezové oceli AISI316
- Rozměr: 160 x 160 mm
- Napojení: 2" Int.

**VAGNER**  
POOL



480010  
430010

**AISI 316**  
STAINLESS STEEL  
NEREZ



480030  
430030

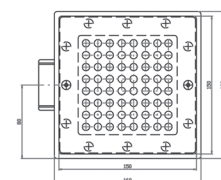
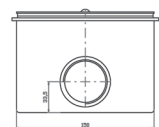
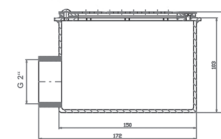

### Main drain – square

- Made of stainless steel AISI316
- Dimensions: 160 x 160 mm
- Connection: 2" Int.

Podlahová výpust nerez   Main drain stainless steel					cena Kč	€		
480010	B	Podlahová výpust nerez čtvercová s přírubou pro fólii, napojení 2" int. Main drain stainless steel square with flange for liner, connection 2" int.			1	1,85	7 458,-	
430010	B	Podlahová výpust nerez čtvercová do betonu, napojení 2" int. Main drain stainless steel square for concrete, connection 2" int.			1	1,85	6 008,-	
480030	B	Podlahová výpust nerez čtvercová s přírubou pro fólii, napojení 2" int. – jemná mřížka Main drain stainless steel square with flange for liner, connection 2" int. – thin grating			1	1,85	7 764,-	
430030	B	Podlahová výpust nerez čtvercová do betonu, napojení 2" int. – jemná mřížka Main drain stainless steel square for concrete, connection 2" int. – thin grating			1	1,85	5 947,-	



33330

**Sání**

- Vyrobeno z bílého plastu ABS
- Ø mřížky 162 mm
- Napojení lepením Ø 63 mm nebo závitem 2½" ext.
- Včetně příruby a dvou těsnění
- Doporučená instalace dvou kusů
- Kapacita průtoku 35 m³/h

**Suction**

- Made of white ABS
- Ø of the grating – 162 mm
- Connection with glue Ø 63 mm or thread 2½" ext.
- Includes flange and 2 seals
- Use of 2 pieces advised
- Flow capacity 35 m³/h

Sání   Suction					cena Kč	€
33330	B	Sání pro 35 m³/h, s přírubou pro fólii, napojení 63/2½" ext. Suction of 35 m³/h, with flange for liner, connection 63/2½" ext.		2	1,50	894,-



33303

**Sání**

Sání pro 40 m³/h s přírubou pro fólii napojením lepením 90 mm.

**Suction**

Suction 40 m³/h with liner flange, connection 90 mm.

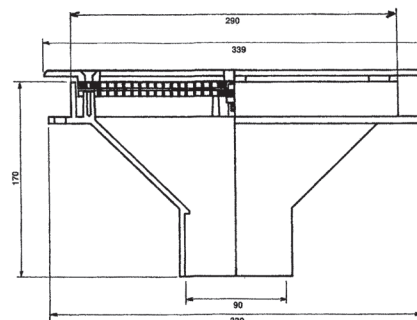

Sání   Suction					cena Kč	€
33303	B	Sání pro 40 m³/h, s přírubou pro fólii, napojení lepením 90 mm Suction of 40 m³/h, with flange for a liner, connection 90 mm		1	2,50	6 985,-



33320

**Sání pro přelivové žlábký**

- Vyrobeno z bílého plastu ABS
- Rozměr 142 mm x 69 mm
- Obdélníkový rošt připevněn nerezovými šrouby
- Napojení lepením Ø 63 mm
- Kapacita průtoku 9 m³/h

**Suction for overflow channel**

- Made of white ABS
- Dimensions 142 mm x 69 mm
- Rectangle grating fixed with stainless steel screws
- Connection with glue Ø 63 mm
- Flow capacity 9 m³/h

Sání pro přelivové žlábký   Suction for overflow channel					cena Kč	€
33320	B	Sání pro přelivové žlábký, napojení lepením 63 mm Suction for overflow channel, connection 63 mm		1	0,20	230,-



313194



313196

**AISI 316**  
STAINLESS STEEL  
N E R E Z

**VAGNER**  
POOL

### Sání VAMILA NEREZ



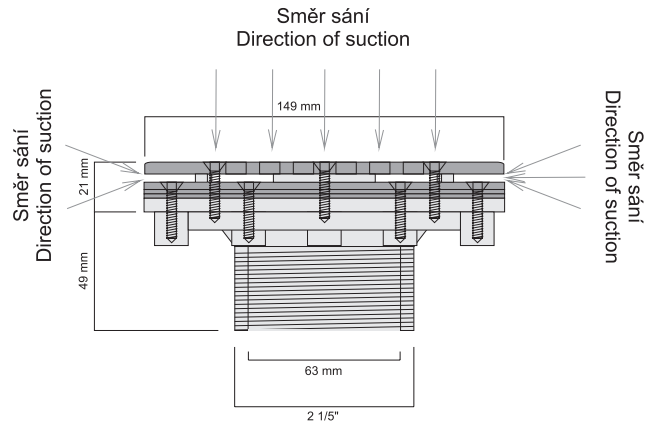

- Mřížka je vyrobena z nerezové oceli AISI 316, tělo ABS
- Napojení Ø 63 mm int./2½" ext.

### Suction ST. STEEL VAMILA

- AISI 316 grating, ABS body
- Connection with glue Ø 63 mm int./2½" ext.



### Sání VAMILA nerez | Suction stainless steel VAMILA

fólie liner	beton concrete				KG	KG	cena Kč	cena Kč	€
					folie	beton			
313194	313195	B	Sání VAMILA nerez, 30 m³/h Suction VAMILA st. steel, 30 m³/h	 	1	1,15	0,95	3 240,-	2 575,-
313196	313197	B	Sání VAMILA nerez, napojení Ø 63 mm int./2½" ext., 30 m³/h - jemná mřížka Suction VAMILA st. steel, connection glue Ø 63 mm int./2½" ext., 30 m³/h - thin grating	 	1	0,30	0,95	3 611,-	2 946,-



4211



4218

**AISI 316**  
STAINLESS STEEL  
N E R E Z

### Sání Uni-set

- Slouží pro nasávání vody např. protiproudu, vodních atrakcí atd.
- Kapacita průtoku 3,6 m³/h

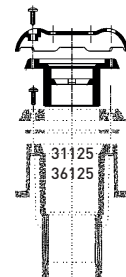
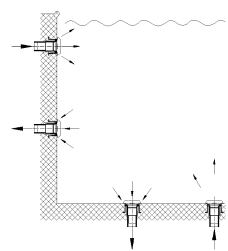

### Suction Uni-set

- Suction for counter-currents, water attractions etc.
- Flow capacity 3,6 m³/h



**MTS** | VOM GLITEN  
SCHWIMMBADTECHNIK DAS BESTE

### Sání Uni-set | Suction Uni-set

					KG	cena Kč	€
4211	B	Sání Uni-set 2" x 50 mm ABS Suction Uni-set 2" x 50 mm ABS		50	0,17	946,-	
4218	B	Sání Uni-set 2" x 50 mm nerez Suction Uni-set 2" x 50 mm stainless steel		50	0,21	1 740,-	





**Sání Cofies**

Sání pro 10 m<sup>3</sup>/h je možno dovybavit nerezovou přírubou a nerezovou mřížkou.

**Suction Cofies**

10 m<sup>3</sup>/h suction can be equipped with stainless steel flange and grating.

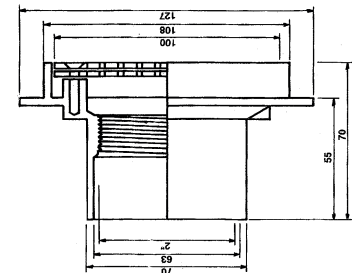

Sání   Suction			KG	cena Kč	€	
33319	B	Sání pro 10 m <sup>3</sup> /h, s přírubou pro fólii, napojení lepením 63 mm Suction of 10 m <sup>3</sup> /h, with flange for liner, connection 63 mm for to glue	40	0,30	973,-	
33321	B	Sání pro 10 m <sup>3</sup> /h, s přírubou pro fólii, nerez, napojení lepením 63 mm Suction of 10 m <sup>3</sup> /h, with flange for liner, stainless steel, connection 63 mm for to glue	40	0,60	2 982,-	
333191	B	Mřížka nerez pro sání 33319 Stainless steel grating for suction 33319	1	0,10	1 069,-	
333192	B	Příruba nerez pro sání 33319 Stainless steel flange for suction 33319	1	0,20	703,-	



**Podlahová tryska**

- Tělo vyrobeno z bílého plastu ABS
- Nastavitelný průtok 0-100 %
- Určeno pro instalaci do dna bazénu
- Model pro fólii včetně příruby a dvou těsnění
- Kapacita průtoku 14 m<sup>3</sup>/h
- Možno dovybavit přírubou a mřížkou z nerez

**Bottom closing nozzle**

- Body made of white ABS
- Adjustable flow rate 0-100 %
- Installation to the bottom of the pool
- Model designed for liner pools includes a flange and two seals
- Flow capacity 14 m<sup>3</sup>/h
- Can be equipped with flange and stainless steel grating

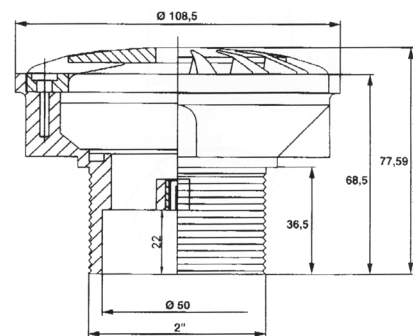

Podlahová tryska   Bottom closing nozzle			KG	cena Kč	€	
313190	B	Podlahová tryska 14 m <sup>3</sup> /h, pro beton, napojení lepením 50 mm nebo 2" ext. Bottom nozzle 14 m <sup>3</sup> /h closing – for concrete, connect with glue 50 mm or 2" ext.	24	0,20	273,-	
313191	B	Podlahová tryska 14 m <sup>3</sup> /h, pro fólii, napojení lepením 50 mm nebo 2" ext. Bottom nozzle 14 m <sup>3</sup> /h closing – for liner, st. steel, connect with glue 50 mm or 2" ext.	24	0,30	531,-	
313192	B	Podlahová tryska 14 m <sup>3</sup> /h, pro beton, nerez, napojení lepením 50 mm nebo 2" ext. Bottom nozzle 14 m <sup>3</sup> /h closing – for concrete, st. steel, connect with glue 50 mm or 2" ext.	24	0,50	1 671,-	
313193	B	Podlahová tryska 14 m <sup>3</sup> /h, pro fólii, nerez, napojení lepením 50 mm nebo 2" ext. Bottom nozzle 14 m <sup>3</sup> /h closing – for liner, st. steel, connect with glue 50 mm or 2" ext.	24	0,60	2 770,-	
3131901	B	Mřížka nerez pro podlahovou trysku 313191 Stainless steel grating for Bottom closing nozzle 313191	1	0,10	1 236,-	
3131911	B	Příruba nerez pro podlahovou trysku 313191 Stainless steel flange for Bottom closing nozzle 313191	1	0,20	816,-	
3131902	B	Mřížka nerez pro podlahovou trysku 313190 Stainless steel grating for Bottom closing nozzle 313190	1	0,15	1 351,-	

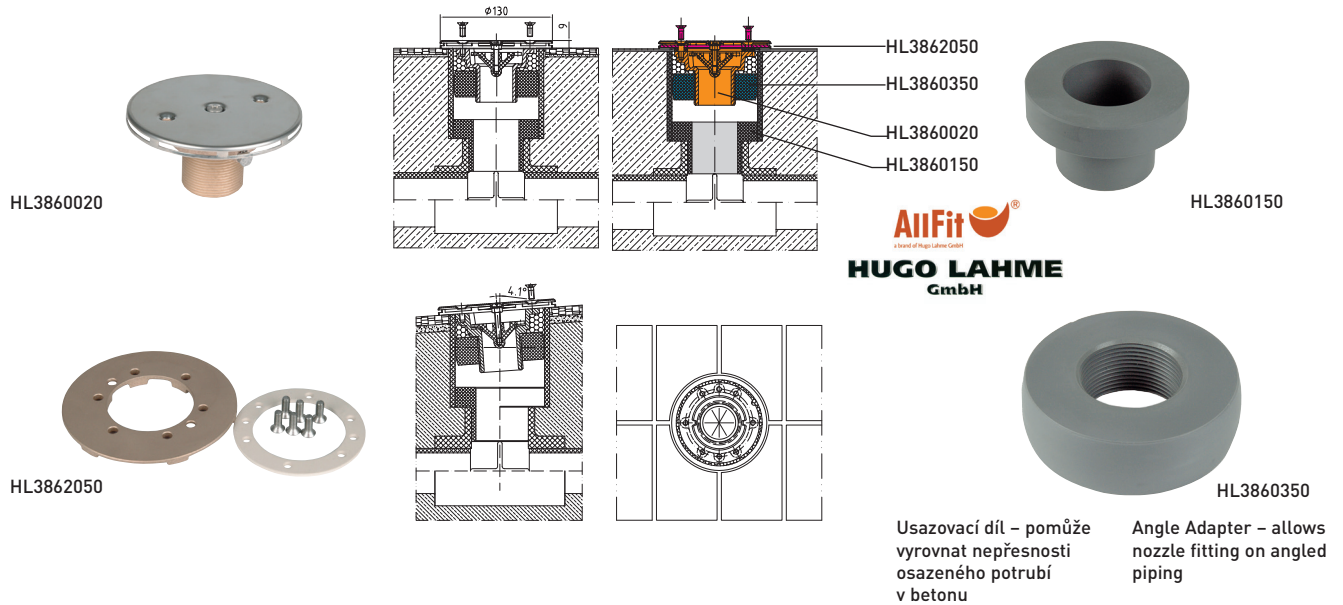

Podlahová tryska   Bottom closing nozzle					cena Kč	€
HL3860020	D	Podlahová tryska – závit 1 1/2" ext., regulovatelný a uzavíratelný kryt Bottom closing nozzle – thread 1 1/2" ext., adjustable and closeable covering		1	0,9	3 765,-
HL3860150	A	Spodní přípojovací díl – napojení Ø 63 mm ext. Bottom connecting part – connection Ø 63 mm ext.		1	1,9	1 171,-
HL3860350	D	Usazovací díl – napojení 1 1/2" int. Settle part – connection 1 1/2" int.		1	1,0	999,-
HL3862050	D	Přírubová sada k podlahové trysce pro fóliové bazény Flange set for bottom closing nozzle		1	0,2	1 401,-



Podlahová výpust   Bottom outlet					cena Kč	€
HL2005020	D	Podlahová výpust, napojení 2" int., protivířivý kryt Ø 168 mm Bottom outlet, connection 2" int., antiwhirl covering Ø 168 mm		1	1,1	3 894,-
HL2015020	D	Podlahová výpust, napojení 2" int. 90°, protivířivý kryt Ø 168 mm Bottom outlet, connection 2" int. 90°, antiwhirl covering Ø 168 mm		1	3,6	4 790,-
HL2030050	D	Přírubová sada k podlahové výpusti pro fóliové bazény Flange set for bottom outlet for liner pools		1	0,3	1 350,-

**AiiFit**  
a brand of HUGO LAHME GmbH  
**HUGO LAHME**  
GmbH

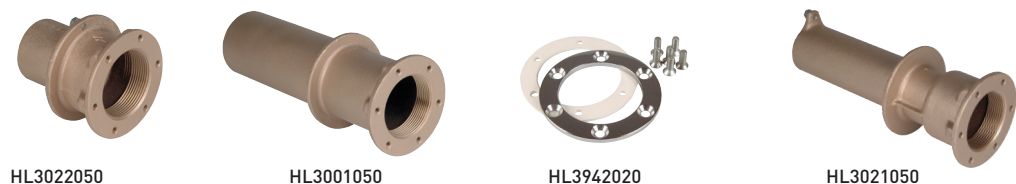

Průchod stěnou   Poolwall lead-through					cena Kč	€
HL3022050	D	Průchod stěnou pro keramické a fóliové bazény – 2" x 1 1/2", délka 100 mm Poolwall lead-through for ceramic and liner pools – 2" x 1 1/2", length 100 mm		1	0,6	2 542,-
HL3001050	D	Průchod stěnou pro keramické a fóliové bazény – 2" x 2", délka 240 mm Poolwall lead-through for ceramic and liner pools – 2" x 2", length 240 mm		1	0,7	3 601,-
HL3021050	D	Průchod stěnou pro keramické a fóliové bazény – 2" x 1 1/2", délka 240 mm Poolwall lead-through for ceramic and liner pools – 2" x 1 1/2", length 240 mm		1	2,0	3 371,-
HL3942020	D	Přírubová sada k sání pro fóliové bazény (s použitím průchodu stěnou) Flange set for suction for liner pools (using poolwall lead-through)		1	0,1	1 254,-



HL3800000

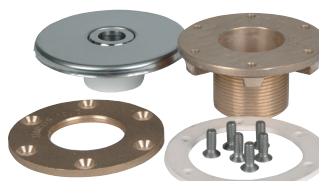

HL3103420



HL3101420



HL3782420



HL3102020

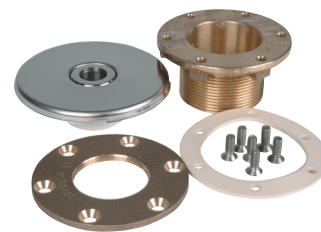

HL3104420

Vtoková tryska   Inlet nozzle					cena Kč	€
HL3100420	D	Vtoková tryska Ø 18 mm – závit 1½" ext., délka 40 mm Inlet nozzle Ø 18 mm – thread 1½" ext., length 40 mm		1	0,5	2 181,-
HL3101420	D	Vtoková tryska Ø 18 mm – závit 2" ext., délka 40 mm Inlet nozzle Ø 18 mm – thread 2" ext., length 40 mm		1	0,6	2 666,-
HL3800000	D	Vtoková tryska plochá – závit 2" ext., délka 40 mm Inlet nozzle flat – thread 2" ext., length 40 mm		1	0,4	3 279,-
HL3780420	D	Vtoková mušle – závit 1½" ext., délka 40 mm Inlet shell – thread 1½" ext., length 40 mm		1	0,2	2 336,-
HL3782420	D	Vtoková mušle – závit 2" ext., délka 40 mm Inlet shell – thread 2" ext., length 40 mm		1	0,5	2 539,-
HL3102020	D	Vtoková tryska Ø 18 mm s přírubou pro fóliové bazény Inlet nozzle Ø 18 mm with flange for liner pools		1	0,4	2 302,-
HL3103420	D	Vtoková tryska Ø 18 mm – závit 1½" ext., délka 40 mm s přírubou pro fóliové bazény Inlet nozzle Ø 18 mm – thread 1½" ext., length 40 mm with flange for liner pools		1	0,3	3 150,-
HL3104420	D	Vtoková tryska Ø 18 mm – závit 2" ext., délka 40 mm s přírubou pro fóliové bazény Inlet nozzle Ø 18 mm – thread 2" ext., length 40 mm with flange for liner pools		1	0,3	3 789,-



HL3915020



HL3920000



HL3945020



HL3950050



HL3930000

Sací tryska Hugo Lahme   Suction nozzle Hugo Lahme					cena Kč	€
HL3945020	D	Sací tryska s přírubou pro fol. bazény – napojení 2" ext., délka 40 mm Suction nozzle with flange for liner pools – connection 2" ext., length 40 mm		1	0,1	3 047,-
HL3915020	D	Sací tryska pro bazény – napojení 2" ext., délka 40 mm Suction nozzle for pools – connection 2" ext., length 40 mm		1	1,3	2 063,-
HL3950050	D	Kontramatka 2" int. s těsněním k sacím tryskám pro předvyrobené bazény Back nut 2" with sealing for suction nozzles for prefabricated pools		1	0,5	582,-
HL3920000	D	Hadicový trn Ø 38 mm s O-kroužkem Hose pin Ø 38 mm with O-ring		1	0,4	1 120,-
HL3930000	D	Zátka sací trysky s O-kroužkem Suction nozzle plug with O-ring		1	0,3	1 350,-

**VAMILA**

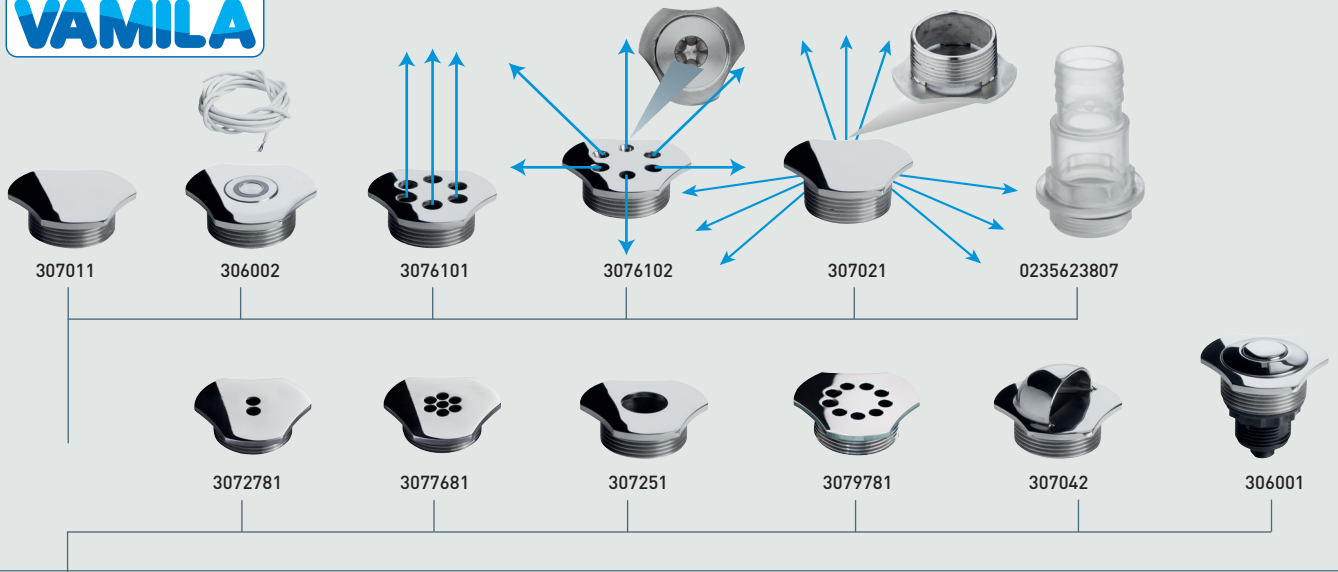

**VAGNER**  
POOL

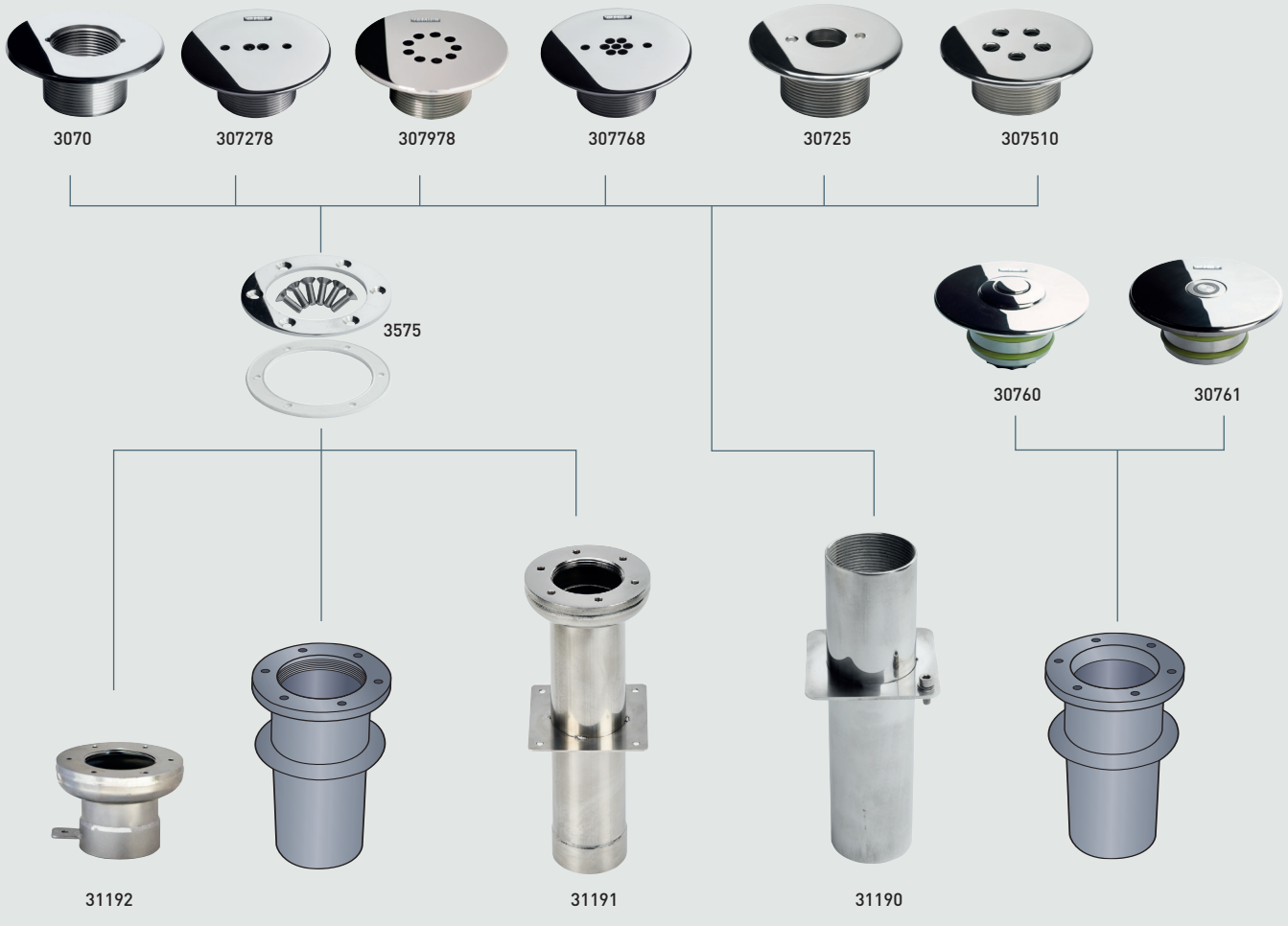

**Trysky VAMILA NEREZ**

Trysky jsou vyrobeny z nerezové oceli AISI 316.

Montážní klíč  
Assembly spanner



30702



30705



Použití rámečku s tryskou VAMILA  
Example of using the VAMILA frame



Tryska VAMILA nerez   Nozzle stainless steel VAMILA				cena Kč	€
31192	B Průchod stěnou bazénu 2" – VAMILA nerez krátký – pro fólii Poolwall lead-through 2" – VAMILA stainless steel short – for foil			1 0,75 3 910,-	
31191	B Průchod stěnou bazénu pro fólii nerez R 2", délka 300 mm Poolwall lead-through for liner stainless steel R 2", length 300 mm			1 1,20 4 105,-	
31190	B Průchod stěnou bazénu nerez R 2", délka 300 mm Poolwall lead-through stainless steel R 2", length 300 mm			1 0,20 2 499,-	
3575	B Přírubová sada VAMILA k sání pro fólii (s použitím průchodu stěnou) Flange set VAMILA for suction for liner (using pool wall lead-through)			1 0,10 806,-	
3070	B Základní prvek VAMILA nerez Basic element VAMILA stainless steel			1 0,40 1 741,-	
307278	B Vtoková tryska VAMILA nerez 2 x 7,8 mm AG R 2" x R 1/2" IG závit 40 mm Inlet nozzle VAMILA stainless steel 2 x 7,8 mm AG R 2" x R 1/2" IG thread 40 mm			1 0,60 1 885,-	
307978	B Vtoková tryska VAMILA nerez 9 x 7,8 mm Inlet nozzle VAMILA stainless steel 9 x 7,8 mm			1 0,55 1 917,-	
307768	B Vtoková tryska VAMILA nerez 7 x 6,8 mm AG R 2" x R 1/2" IG závit 40 mm Inlet nozzle VAMILA stainless steel 7 x 6,8 mm AG R 2" x R 1/2" IG thread 40 mm			1 0,60 1 885,-	
30725	B Vtoková tryska VAMILA nerez Ø 25 mm AG R 2" x R 1/2" IG závit 40 mm Inlet nozzle VAMILA stainless steel Ø 25 mm AG R 2" x R 1/2" IG thread 40 mm			1 0,50 1 882,-	
307510	B Vtoková tryska VAMILA nerez 5 x Ø 10 mm AG R 2" x R 1/2" IG závit 40 mm Inlet nozzle VAMILA stainless steel 5 x Ø 10 mm AG R 2" x R 1/2" IG thread 40 mm			1 0,50 1 882,-	
3072783	B Vtoková tryska VAMILA nerez s kuličkou 2 x 7,8 mm Inlet nozzle VAMILA stainless steel with ball 2 x 7,8 mm			1 0,80 3 219,-	
3077683	B Vtoková tryska VAMILA nerez s kuličkou 7 x 6,8 mm Inlet nozzle VAMILA stainless steel with ball 7 x 6,8 mm			1 0,80 3 219,-	
30765	B Vzduchový regulátor VAMILA Air regulator VAMILA			1 0,60 2 499,-	
307253	B Vtoková tryska VAMILA nerez s kuličkou Ø 25 mm Inlet nozzle VAMILA stainless steel with ball Ø 25 mm			1 0,80 3 219,-	
30760	B Pneumatické tlačítko VAMILA Pneumatic button VAMILA			1 0,10 2 213,-	
30761	B Piezoelektrické tlačítko VAMILA Piezoelectric button VAMILA			1 0,40 4 575,-	
3072781	B Vtoková část trysky VAMILA nerez 2 x 7,8 mm Inlet part of nozzle VAMILA stainless steel with ball 2 x 7,8 mm			1 0,10 795,-	
3077681	B Vtoková část trysky VAMILA nerez 7 x 6,8 mm Inlet part of nozzle VAMILA stainless steel with ball 7 x 6,8 mm			1 0,10 811,-	
307251	B Vtoková část trysky VAMILA nerez Ø 25 mm Inlet part of nozzle VAMILA stainless steel Ø 25 mm			1 0,10 795,-	
3079781	B Vtoková část trysky VAMILA nerez 9 x 7,8 mm Inlet part of nozzle VAMILA stainless steel with ball 9 x 7,8 mm			1 811,-	
307042	B Vtoková mušle VAMILA nerez Inlet shell VAMILA stainless steel			1 0,20 1 355,-	
306001	B Pneumatické tlačítko do základního prvku VAMILA Pneumatic button to basic element VAMILA			1 0,10 1 099,-	
307011	B Uzávěr trysky VAMILA nerez Cap nozzle VAMILA stainless steel			1 0,10 768,-	
306002	B Piezoelektrické tlačítko do základního prvku VAMILA Piezoelectric button to basic element VAMILA			1 0,10 3 600,-	
3076101	B Vtoková část trysky VAMILA nerez 6 x Ø 10 mm, kolmý proud vody Inlet part of nozzle VAMILA stainless steel 6 x Ø 10 mm, direct flow water			1 0,10 768,-	
3076102	B Vtoková část trysky VAMILA nerez 6 x Ø 8 mm, šikmý proud vody Inlet part of nozzle VAMILA stainless steel 6 x Ø 8 mm, angled water flow			1 0,30 1 655,-	
307021	B Podlahová tryska VAMILA nerez Bottom closing nozzle VAMILA stainless steel			1 0,20 1 019,-	
0235623807	B Trn hadicový 38 x 1/2" transparentní Hose adaptor 38 x 1/2" transparent			1 0,10 157,-	
30702	X Montážní klíč VAMILA nerez – univerzál Assembly spanner for VAMILA stainless. steel – universal			1 0,30 312,-	
30705	B Nerezový rámeček trysky VAMILA – hranatý Stainless steel nozzle frame VAMILA – square			1 0,50 913,-	

**Tryskový komplet VA**

- Kontramatka vždy součástí
- Tělo závit 2" ext.
- Napojení lepením 50 mm

**Nozzle set VA**

- Counter-nut included
- Nozzle body with 2" ext. thread
- Connection with glue 50 mm

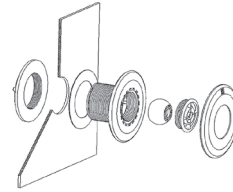
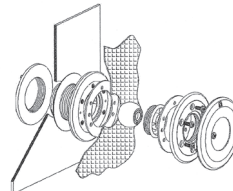
Předvyrobené bazény  
Prefabricated poolsFóliové bazény  
Liner poolsMosazné zástříky  
With brass inserts

Tryskový komplet VA   Nozzle set VA				KG	cena Kč	€
313153	B	Tryskový set Eco, připojení hadicí 32/38 mm, pro předvyrobené bazény, bílá ABS Nozzle set Eco, connect by hose 32/38 mm, for prefabricated pools, white ABS		80	0,25	187,-
3131294	B	Mřížka do vtokové trysky VA Grille for nozzle VA		1	0,10	48,-
313143	B	Uzávěr pro tryskový set VA, bílá ABS Cap for Nozzle set VA, white ABS		1	0,03	46,-
313140	B	Tryskový set VA, pro předvyrobené bazény, připojení lepením 50 mm, bílá ABS Nozzle set VA, for prefabricated pools, connect with glue 50 mm, white ABS	 	24	0,25	399,-
3131404	B	Tryskový set VA pro předvyrobené bazény, připojení lepením 50 mm, světle šedá, RAL 7004 Nozzle set VA for prefabricated pools, connect with glue 50 mm, light grey, RAL 7004		24	0,25	429,-
3131405	B	Tryskový set VA pro předvyrobené bazény, připojení lepením 50 mm, tmavě šedá, RAL 7016 Nozzle set VA for prefabricated pools, connect with glue 50 mm, dark grey, RAL 7016		24	0,25	429,-
313141	B	Tryskový set VA, s mosaznými zástříky, pro fólii, připojení lepením 50 mm, bílá ABS Nozzle set VA, with brass inserts, for liner, connect with glue 50 mm, white ABS	 	12	0,25	612,-
3131414	B	Tryskový set VA, s mosaznými zástříky, pro fólii, připojení lepením 50 mm, světle šedá, RAL 7004 Nozzle set VA, with brass inserts, for liner, connect with glue 50 mm, light grey, RAL 7004		12	0,25	618,-
3131415	B	Tryskový set VA, s mosaznými zástříky, pro fólii, připojení lepením 50 mm, tmavě šedá, RAL 7016 Nozzle set VA, with brass inserts, for liner, connect with glue 50 mm, dark grey, RAL 7016		12	0,25	618,-

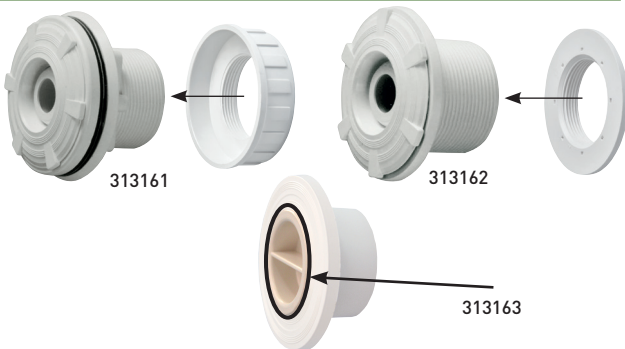
**Tryskový komplet**

- Trysky jsou vyrobeny z bílého ABS
- Kontramatka vždy součástí
- Tělo závit 2" ext.
- Napojení lepením 50 mm

**Nozzle set**

- Made of white ABS
- Counter-nut included
- Nozzle body with 2" ext. thread
- Connection with glue 50 mm



Tryskový komplet   Nozzle set				KG	cena Kč	€
313161	B	Tryskový komplet, 20 mm (5 m³/h), pro fólii, připojení lepením 50 mm Nozzle set, 20 mm (5 m³/h), for liner, connect with glue 50 mm	 	12	0,30	407,-
313162	B	Tryskový komplet, 20 mm (5 m³/h), pro předvyr. bazény, připojení lep. 50 mm Nozzle set, 20 mm (5 m³/h), for prefabricated pools, connect with glue 50 mm	 	12	0,25	351,-
313163	B	Uzávěr pro trysky Cap for Nozzles		1	0,02	161,-



Tryskový komplet Cofies/Hayward   Nozzle set Cofie/Hayward				KG	cena Kč	€
313151	B	Tryskový komplet Cofies, 21 mm (6 m³/h), pro fólii, včetně kontramátky, připojení lepením 50 mm Nozzle set Cofies, 21 mm (6 m³/h), for liner, contra nut included, connect with glue 50 mm		1	0,25	684,-
HSP1408E19	B	Tryskový komplet Hayward, 19 mm (5-6 m³/h), pro fólii, včetně kontramátky, připojení lepením 50 mm Nozzle set Hayward, 19 mm (5-6 m³/h), for liner, contra nut included, connect with glue 50 mm		1	0,25	617,-

**Přísávací díl k trysece VA**

Hydromasážní nástavec

Sada obsahuje pohonnou trysku (2) a pouzdro (1), které je opatřeno přívodem vzduchu a tryskou venturi. Souprava smíchává vzduch s vodou a vytváří bubliny, které poskytují jemnou masáž.

**Charakteristika:**

- Instalace 300–500 mm pod hladinou vody
- Minimální průtok 5 m<sup>3</sup>/h pro každou tryšku
- Maximální průtok 10 m<sup>3</sup>/h pro každou tryšku
- Vyrobeno z plastu ABS

**Pozor:** pokud je umístěna hlouběji, je potřeba vzduchové čerpadlo.

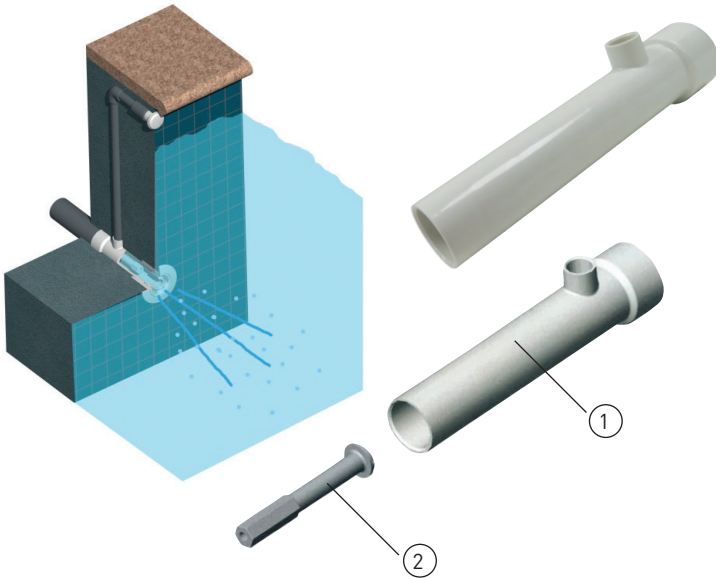

**Air mix part of nozzle VA**

Hydromassage Kit

The Kit includes a drive nozzle (2) and a bushing (1), which is provided with an air intake and venturi nozzle. The Kit mixes air with water to provide bubbles, which give a gentle massage.

**Characteristics:**

- Installation depth: 300–500 mm Underneath the level of the water
- The minimum flow rate of 5 m<sup>3</sup>/h by each nozzle
- The maximum flow rate of 10 m<sup>3</sup>/h by each nozzle
- Material: ABS plastic

**Attention:** if it is placed deeper an air pump is needed.

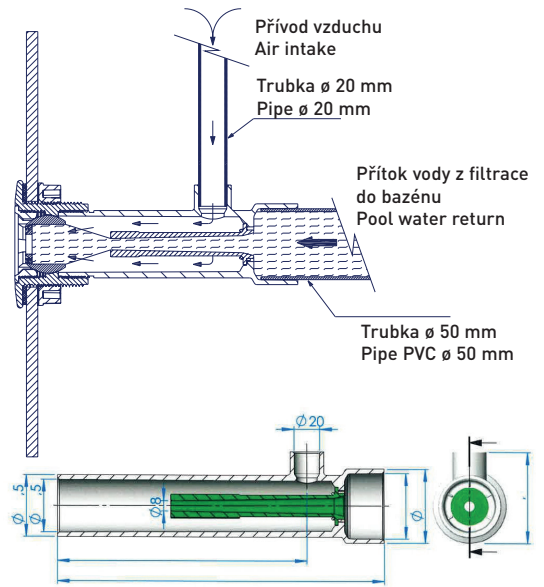

Přísávací díl k trysece VA   Air mix part of nozzle VA						cena Kč	€
31188771	B	Přísávací díl k trysece VA Ø 47 mm, včetně redukce 50–47 mm Air mix part of nozzle VA Ø 47 mm, reduction socket 50–47 mm included		65	0,35	474,-	



31200

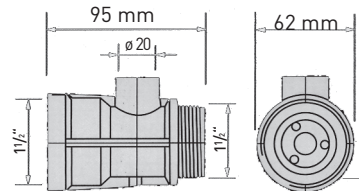

Vzduchovací mixační nástavec   Air-mixing part						cena Kč	€
31200	B	Vzduchovací mixační nástavec, pro přísávání vzduchu do proudu vody vtokovou tryškou Air-mixing part of nozzle sucking air into the water stream coming out of the inlet nozzle		1	0,30	219,-	

**Průchod stěnou**

**Poolwall lead through**

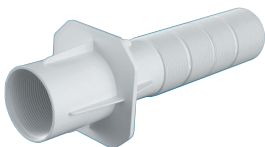

3151



3152

Pro trysku 313161  
For nozzle 313161



3115663

Pro trysku 313141  
For nozzle 313141



311A029

Průchod stěnou bazénu   Poolwall lead-through						cena Kč	€
3151	B	Průchod stěnou Kripsol R 2" x 50 mm, délka 300 mm Poolwall lead-through Kripsol R 2" x 50 mm, length 300 mm		1	0,34	280,-	
3152	B	Průchod stěnou Kripsol R 2" x 50 mm s hrdlem, délka 300 mm Poolwall lead-through Kripsol R 2" x 50 mm with a throat, length 300 mm		12	0,35	280,-	
3115663	B	Průchod stěnou VA R 2" x 50 mm, délka 300 mm Poolwall lead-through VA R 2" x 50 mm, length 300 mm		12	0,35	211,-	
311A029	B	Průchod stěnou R 2" x 50 mm, délka 246 mm Poolwall lead through R 2" x 50 mm, length 246 mm		24	0,41	182,-	



31244



312445

RAL7037



31247

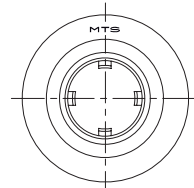
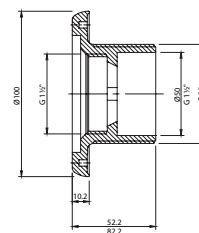

Tryska MTS   Nozzle MTS				KG	cena Kč	€	
31244	B	Základní prvek R 2" připojení lepením 50 mm ABS – délka 40 mm Basic element R 2" to connect with glue 50 mm ABS – length 40 mm			250	0,10	323,-
312441	B	Základní prvek R 2" připojení lepením 50 mm ABS – délka 40 mm, bílá barva Basic element R 2" to connect with glue 50 mm ABS – length 40 mm, white color			250	0,10	350,-
31247	B	Základní prvek R 2" připojení lepením 50 mm ABS – délka 70 mm Basic element R 2" to connect with glue 50 mm ABS – length 70 mm			180	0,10	384,-
31254	B	Základní prvek R 2" připojení závitem AG 2" x 1 1/2" ABS – délka 40 mm Basic element R 2" to connect with thread AG 2" x 1 1/2" ABS – length 40 mm			250	0,10	416,-
31257	B	Základní prvek R 2" připojení závitem AG 2" x 1 1/2" ABS – délka 70 mm Basic element R 2" to connect with thread AG 2" x 1 1/2" ABS – length 70 mm			180	0,10	478,-
312445	B	Základní prvek R 2" připojení lepením 50 mm šedá – délka 40 mm Basic element R 2" to connect with glue 50 mm grey – length 40 mm				0,10	381,-
312545	B	Základní prvek R 2" připojení závitem AG 2" x 1 1/2" šedá – délka 40 mm Basic element R 2" to connect with thread AG 2" x 1 1/2" grey – length 40 mm				0,10	462,-



36244

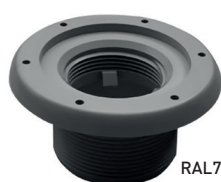

362445

RAL7037



31241

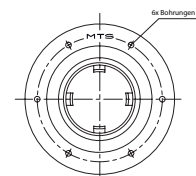
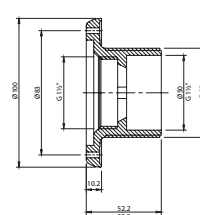

Tryska MTS   Nozzle MTS				KG	cena Kč	€	
36244	B	Základní prvek R 2" připojení lepením 50 mm – délka 40 mm, ABS, 6 děr pro přírubovou sadu. Pro fóliové bazény. Basic element R 2" to connect with glue 50 mm – length 40 mm, ABS, 6 openings for flange set. For liner pools.			250	0,10	375,-
36254	B	Základní prvek R 2" připojení závitem AG 2" x 1 1/2" ABS – délka 40 mm, 6 děr pro přírubovou sadu. Pro fóliové bazény. Basic element R 2" to connect with thread AG 2" x 1 1/2" ABS – length 40 mm, 6 openings for flange set. For liner pools.			250	0,10	458,-
362445	B	Základní prvek R 2" připojení lepením 50 mm – délka 40 mm, šedá, 6 děr pro přírubovou sadu. Pro fóliové bazény. Basic element R 2" to connect with glue 50 mm – length 40 mm, grey, 6 openings for flange set. For liner pools.				0,10	431,-
362545	B	Základní prvek R 2" připojení závitem AG 2" x 1 1/2" šedá – délka 40 mm, 6 děr pro přírubovou sadu. Pro fóliové bazény. Basic element R 2" to connect with thread AG 2" x 1 1/2" grey – length 40 mm, 6 openings for flange set. For liner pools.				0,10	537,-
31241	B	Prodloužení základního prvku 50 mm – AG 2" x 50 mm, připojení lepením – vnější Extention of basic element 50 mm – AG 2" x 50 mm, to connect with glue – ext.			100	0,10	271,-



36532



3653215

RAL7037



36533



365335

RAL7037



36536

Rámečky trysek MTS   Frame for MTS nozzles				KG	cena Kč	€	
36532	B	Krycí rámeček pro přírubovou sadu ABS – kulatý Cover frame for flange set ABS – round			200	0,10	200,-
365321	B	Krycí rámeček pro přírubovou sadu ABS – kulatý, bílá Cover frame for flange set ABS – round, white			200	0,10	200,-
3653215	B	Krycí rámeček pro přírubovou sadu ABS – kulatý, šedá Cover frame for flange set ABS – round, grey				0,10	221,-
36533	B	Hranatý krycí rámeček pro základní prvek ABS Square cover frame for basic element ABS				0,10	279,-
365331	B	Hranatý krycí rámeček pro základní prvek ABS, bílá Square cover frame for basic element ABS, white				0,10	279,-
365335	B	Hranatý krycí rámeček pro základní prvek ABS, šedá Square cover frame for basic element ABS, grey				0,10	339,-
36536	B	Kulatý krycí rámeček pro základní prvek ABS Round cover frame for basic element ABS				0,10	279,-
365361	B	Kulatý krycí rámeček pro základní prvek ABS, bílá Round cover frame for basic element ABS, white				0,10	279,-
365365	B	Kulatý krycí rámeček pro základní prvek ABS, šedá Round cover frame for basic element ABS, grey				0,10	339,-



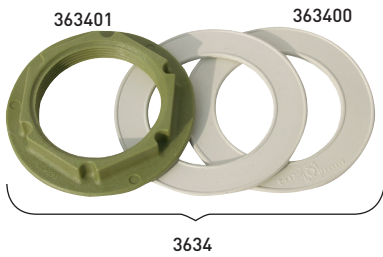

3634

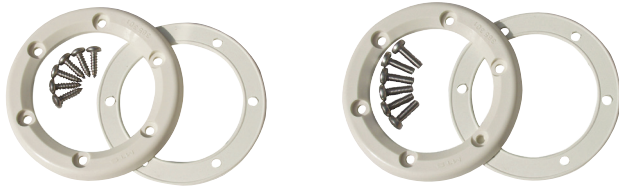
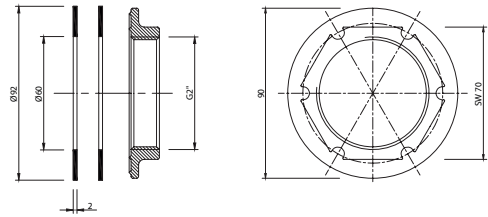

3653

3652

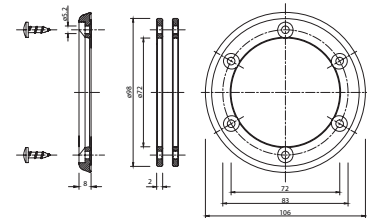

Příslušenství MTS   Accessories MTS					cena Kč	€
363401	B	Kontramatka R 2" PA 6,6 Reverse-nut R 2" PA 6,6		100	0,10	165,-
E3534011	B	Těsnění EPDM R 2", 1 ks Washers EPDM R 2", 1 pc		100	0,10	231,-
3634	B	Kontramatka R 2" PA 6,6 + dvě těsnění EPDM Reverse-nut R 2" PA 6,6 + two washers EPDM		400	0,10	296,-
3653	B	Přírubová sada ABS Pa 6,6 – příruba, 6 x samořez. šroub, těsnění Flange set ABS Pa 6,6 – flange, 6 x selfdrilling screw, washer		250	0,10	478,-
3652	B	Přírubová sada ABS Pa 6,6 – příruba, 6 x šroub M5, těsnění EPDM Flange set ABS Pa 6,6 – flange, 6 x screw M5, washer EPDM		250	0,10	537,-

s mosaznými zástříky  
with brass inserts

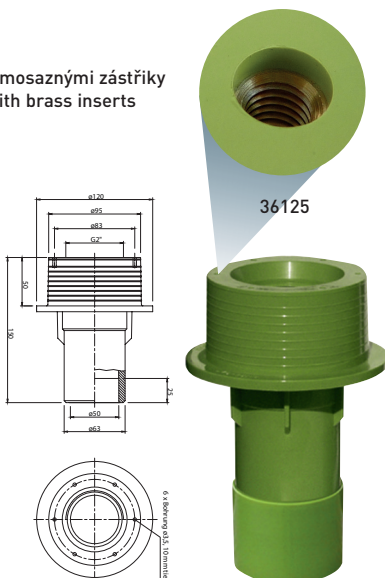

36125

31125

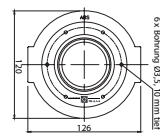
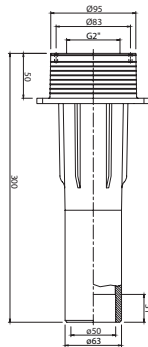

3113

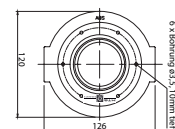
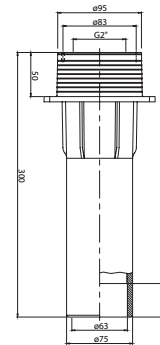

3114

Průchod stěnou bazénu MTS   Pool wall lead-through MTS					cena Kč	€
31125	B	Průchod stěnou bazénu R 2", připojení lepením 50 mm, 63 mm, délka 150 mm Pool wall lead-through R 2", to connect with glue 50 mm, 63 mm, length 150 mm		40	0,15	801,-
36125	B	Průchod stěnou bazénu R 2" s mosaznými zástříky, připojení lepením 50 mm, 63 mm, délka 150 mm Pool wall lead-through R 2" with brass inserts, to connect with glue 50 mm, 63 mm, length 150 mm		40	0,15	937,-
3113	B	Průchod stěnou bazénu R 2", připojení lepením 50 mm, 63 mm, délka 300 mm Pool wall lead-through R 2", to connect with glue 50 mm, 63 mm, length 300 mm		35	0,19	1 169,-
3114	B	Průchod stěnou bazénu R 2", připojení lepením 63 mm, 75 mm, délka 300 mm Pool wall lead-through R 2", to connect with glue 63 mm, 75 mm, length 300 mm		35	0,40	1 201,-

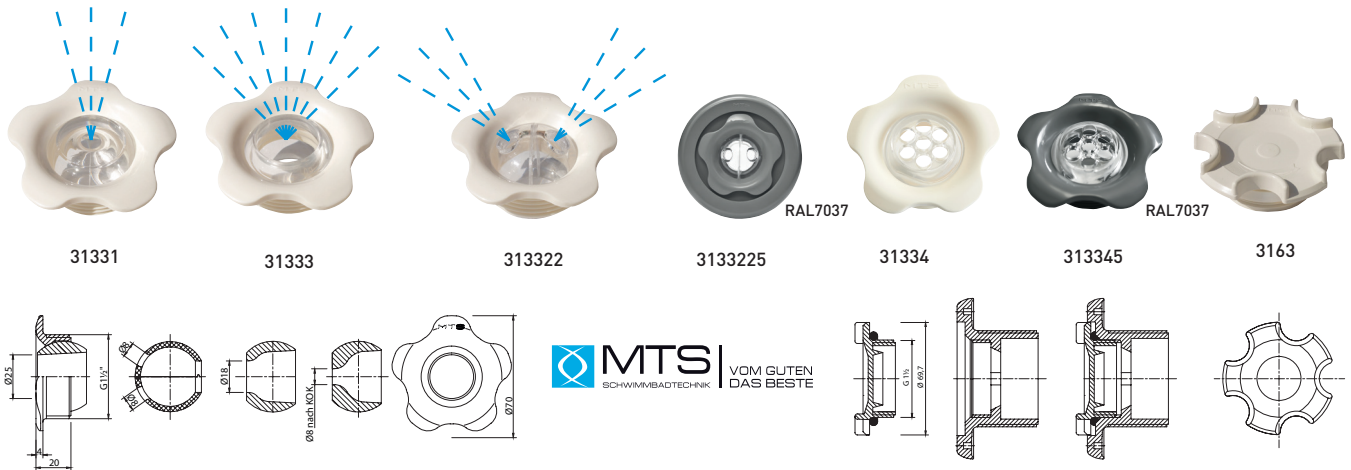

## Vtoková tryska MTS | Inlet nozzle MTS

				cena Kč	€			
31331	B	Vtoková tryska 9 mm – objímka R 1½", koule akryl Inlet nozzle 9 mm – socket R 1½", acrylic ball	 oběbné	 sádkem	250	0,03	252,-	
31333	B	Vtoková tryska 25 mm – objímka R 1½", koule akryl Inlet nozzle 25 mm – socket R 1½", acrylic ball	 oběbné	 sádkem	250	0,03	252,-	
313322	B	Vtoková tryska duo 2 x 8 mm – objímka R 1½", koule akryl Inlet nozzle duble 2 x 8 mm – socket R 1½", acrylic ball		 sádkem	300	0,03	282,-	
3133225	B	Vtoková tryska duo 2 x 8 mm – objímka R 1½", koule akryl, šedá barva Inlet nozzle duble 2 x 8 mm – socket R 1½", acrylic ball, grey color		 sádkem		0,03	308,-	
31334	B	Vtoková tryska 7 x 7 mm ABS – objímka R 1½", koule akryl Inlet nozzle 7 x 7 mm ABS – socket R 1½", acrylic ball		 sádkem		0,03	267,-	
313341	B	Vtoková tryska 7 x 7 mm ABS – objímka R 1½", koule akryl, bílá Inlet nozzle 7 x 7 mm ABS – socket R 1½", acrylic ball, white		 sádkem		0,03	230,-	
313345	B	Vtoková tryska 7 x 7 mm ABS – objímka R 1½", koule akryl, šedá barva Inlet nozzle 7 x 7 mm ABS – socket R 1½", acrylic ball, grey color		 sádkem		0,03	265,-	
3163	B	Uzávěr pro základní prvky R 1½" ABS – s O-kroužkem Cap for basic elements R 1½" ABS – with O-ring	 oběbné	 sádkem	300	0,03	269,-	
3263	B	Uzávěr Transparentní R 1½" pro základní prvky Cap Transparent R 1½" for basic elements		 sádkem	250	0,03	339,-	



3401



3402

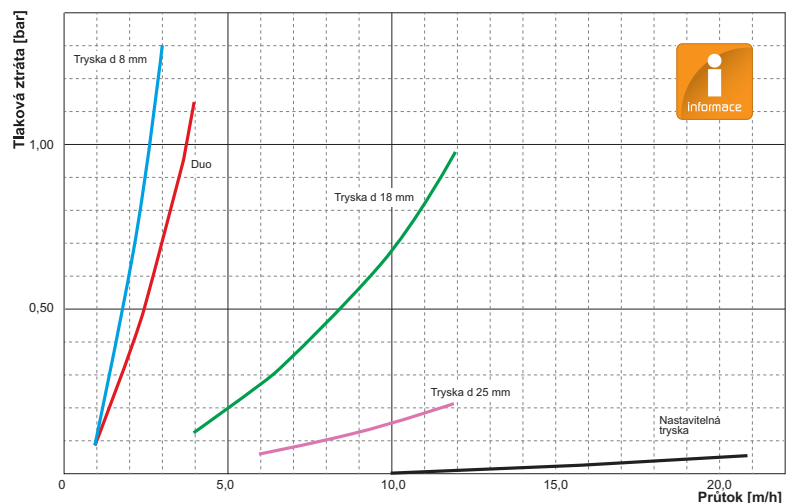

**MTS**  
SCHWIMMBAUTECHNIK

VOM GUTEN  
DAS BESTE

## Příslušenství MTS | Accessories MTS

				cena Kč	€		
3401	X	Montážní klíč – pro základní prvky a vtokové trysky Assembly wrench – for basic elements and inlet nozzles	 sádkem	10	0,05	569,-	
3402	X	Víceúčelový montážní klíč Multi – purpose assembly wrench	 sádkem	10	0,07	367,-	



3143



3243

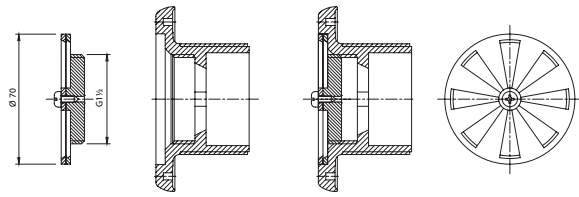

Stavitelný regulátor   Adjustable grate						cena Kč	€
3143	B	Stavitelný regulátor R 1 1/2" ABS – nastavení regulace průtoku vody v základním prvku Adjustable grate R 1 1/2" ABS – water flow regulation in the basic element		40	0,03	259,-	
3243	B	Stavitelný regulátor množství vody, transparentní, 1 1/2" Adjustable grate, controlling water flow, transparent, 1 1/2"		40	0,03	265,-	



3173



3273



31735

RAL7037

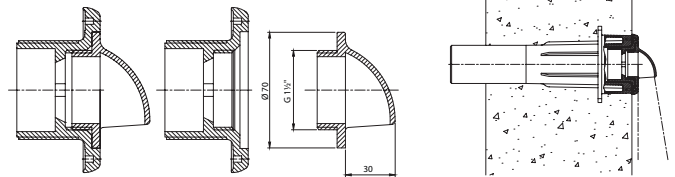

Vtoková mušle   Inlet shell						cena Kč	€
3173	B	Vtoková mušle R 1 1/2" ABS Inlet shell R 1 1/2" ABS		15	0,04	347,-	
3273	B	Vtoková mušle transparentní, R 1 1/2" Inlet shell transparent, R 1 1/2"		15	0,04	395,-	
31735	B	Vtoková mušle šedá R 1 1/2" Inlet shell grey, R 1 1/2"		15	0,04	385,-	



3183



3283

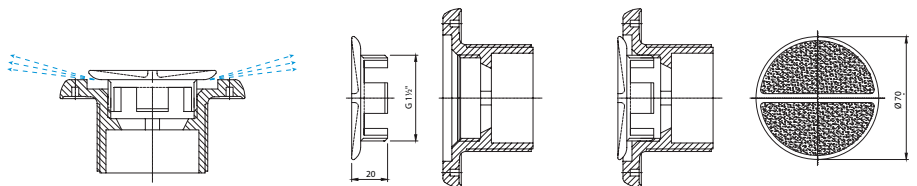

Podlahová tryska   Floor nozzle						cena Kč	€
3183	B	Podlahová tryska R 1 1/2" ABS Floor nozzle R 1 1/2" ABS		40	0,02	167,-	
3283	B	Podlahová tryska transparentní, 1 1/2" Floor nozzle transparent 1 1/2"		40	0,06	188,-	



6313

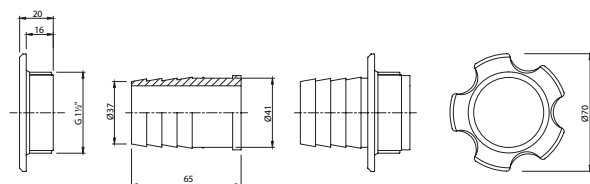

Hubice pro vysavačovou hadici   Nozzle for pool-cleaner hose						cena Kč	€
6313	B	Hubice pro vysavačovou hadici 38 mm s převlečnou matkou ABS – nástavec do základního prvku (např. pro bazén s přelivem) Nozzle for pool-cleaner hose 38 mm with slip nut ABS – extention for basic element (e.g. for overflow pools)		100	0,04	416,-	



3VHY0704



3VHY0705



3VHY0706

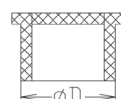

Záslepka   Plug						cena Kč	€
3VHY0704	A	Záslepka D 15 mm Plug D 15 mm		1	0,01	15,-	
3VHY0705	A	Záslepka D 20 mm Plug D 20 mm		1	0,01	19,-	
3VHY0706	A	Záslepka D 32 mm Plug D 32 mm		1	0,01	24,-	

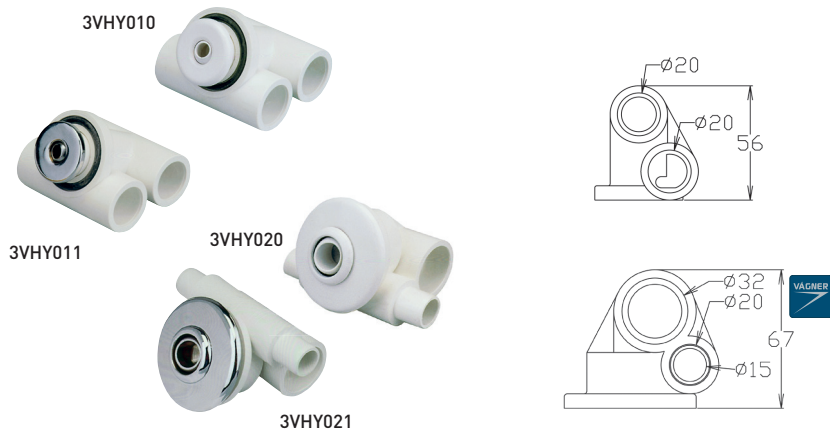

Osazení mikrotrysky  
přírubou pro fólii.  
Liner micronozzle fitted  
with flange.

Hydromasážní tryska pro předvyrobené bazény   Hydromassage nozzle for prefabricated pools			📦	KG	cena Kč	€	
3VHY010	A	Mikrotryska ABS bílá, Ø otvoru 12 mm, vzduch Ø 20 mm, voda Ø 20 mm Micronozzle ABS white, orifice Ø 12 mm, air Ø 20 mm, water Ø 20 mm		1	0,08	270,-	
3VHY011	A	Mikrotryska ABS chrom, Ø otvoru 12 mm, vzduch Ø 20 mm, voda Ø 20 mm Micronozzle ABS chrome, orifice Ø 12 mm, air Ø 20 mm, water Ø 20 mm		1	0,10	301,-	
3VHY020	A	Minitryska 24 ABS bílá, délka 24 mm, Ø otvoru 23 mm, vzduch Ø 20 mm, voda Ø 32 mm Mininozzle 24 ABS white, length 24 mm, orifice Ø 23 mm, air Ø 20 mm, water Ø 32 mm		1	0,28	382,-	
3VHY021	A	Minitryska 24 ABS chrom, délka 24 mm, Ø otvoru 23 mm, vzduch Ø 20 mm, voda Ø 32 mm Mininozzle 24 ABS chrome, length 24 mm, orifice Ø 23 mm, air Ø 20 mm, water Ø 32 mm		1	0,28	431,-	
3VHY002	A	Nerezová příruba + plastový kroužek pro minitrysku do fólie Stainless steel flange + plastic ring for mini nozzle for liner		1	0,15	845,-	



3VHY042



3VHY043

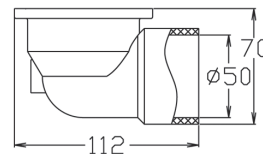

Sání ABS   Suction ABS			📦	KG	cena Kč	€	
3VHY042	A	Sání ABS bílá, pro předvyrobené bazény Suction ABS white, for prefabricated pools		1	0,25	527,-	
3VHY043	A	Sání ABS chrom pro, předvyrobené bazény Suction ABS chrome, for prefabricated pools		1	0,25	543,-	



3VHY071

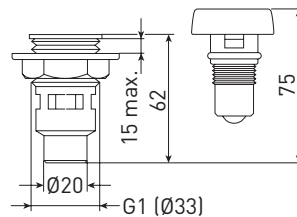

Vzduchový regulátor   Air regulator			📦	KG	cena Kč	€	
3VHY070	A	Vzduchový regulátor bílý se zpětným ventilem, pro předvyrobené bazény Air regulator white with check valve, for prefabricated pools		1	0,12	661,-	
3VHY071	A	Vzduchový regulátor chrom se zpětným ventilem, pro předvyrobené bazény Air regulator chrome with check valve, for prefabricated pools		1	0,12	687,-	



3VHY031

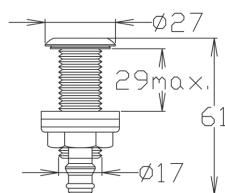

3VHY033

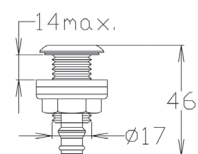

Vzduchová tryska pro předvyrobené bazény   Air-mixing nozzle for prefabricated pools			📦	KG	cena Kč	€	
3VHY031	A	Vzduchová tryska 61 chrom, s krytkou Ø 27 mm, délka 61 mm, Ø otvoru 17 mm Air-mixing nozzle 61 chrome, with cover Ø 27 mm, length 61 mm, orifice Ø 17 mm		1	0,10	636,-	
3VHY033	A	Vzduchová tryska 46 chrom, s krytkou Ø 27 mm, délka 46 mm, Ø otvoru 17 mm Air-mixing nozzle 46 chrome, with cover Ø 27 mm, length 46 mm, orifice Ø 17 mm		1	0,10	619,-	



3VHY0501

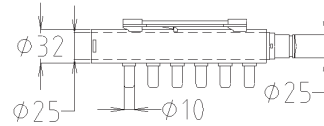

Distributor vzduchu   Air distributor						cena Kč	€
3VHY0501	A	Distributor vzduchu výstup 6 x 10 mm, vstup 32 mm Air distributor 6 x 10 mm outlet, 32 mm inlet		1	0,37	301,-	



3VHY0701



3VHY0509

Příslušenství   Accessories						cena Kč	€
3VHY0701	A	Hadice transparentní 18/23 mm, balení 25 m Transparent hose 18/23 mm, 25 m in packaging		1	0,30	88,-	
3VHY0702	A	T-kus na hadici 20 mm, 90° Hose nozzle - T-piece 20 mm, 90°		1	0,01	74,-	
3VHY0703	A	Stahovací pásek na hadice 22-26 mm Hose clamp 22-26 mm		1	0,01	14,-	
3VHY0506	A	Koleno ke vzduchové trysce Air-mixing nozzle elbow		1	0,01	25,-	
3VHY0507	A	T-kus ke vzduchové trysce Air-mixing nozzle T-piece		1	0,01	29,-	
3VHY0508	A	Stahovací pásek 12-14 mm Fastening belt 12-14 mm		1	0,01	13,-	
3VHY0509	A	Hadice bílá PVC 9/12 mm White PVC hose 9/12 mm		1	0,20	30,-	



3VHY050

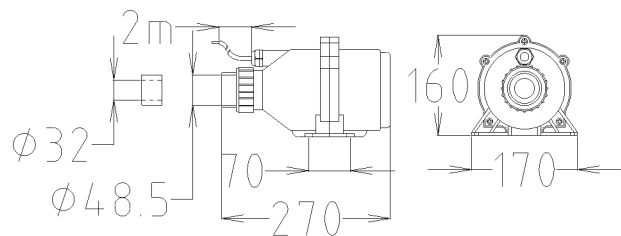

Kompresor – vzduchovač   Air blower compressor						cena Kč	€
3VHY050	A	Kompresor – vzduchovač 400 W/230 V Air blower – compressor 400 W/230 V		1	2,35	3 992,-	
3VHY051	A	Kompresor – vzduchovač 700 W/230 V Air blower – compressor 700 W/230 V		1	2,00	5 772,-	
3VHY059	A	Napojení kompresoru Ø 32 mm, s odvodněním Compressor connection Ø 32 mm, with drainage		1	0,50	166,-	

### Masážní tryska Turbo Jet

- Pro zajištění maximální účinnosti turbo trysky nikdy nepoužívejte čerpadlo o výkonu nižším než 6 m<sup>3</sup>/h nebo vyšším než 15 m<sup>3</sup>/h



HSP1450TVE

### Massage nozzle Turbo Jet

- For best Turbo Jet performance, never use a pump with output lower than 6 m<sup>3</sup>/h or higher than 15 m<sup>3</sup>/h

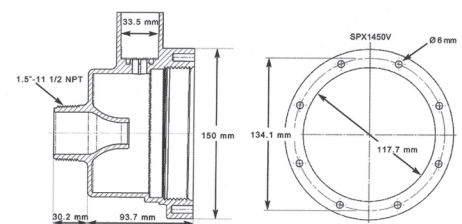

Masážní tryska Turbo Jet   Massage nozzle Turbo Jet						cena Kč	€
HSP1450TVE	B	Masážní tryska Turbo Jet pro fólii Massage nozzle Turbo Jet for liner		1	2,00	1 801,-	

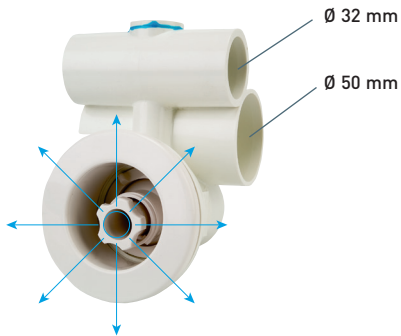

31318

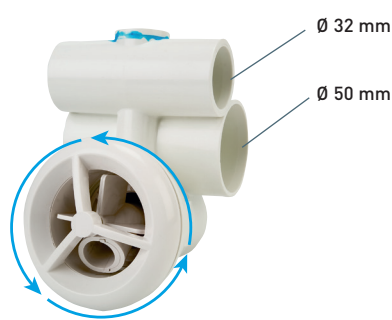

31319

Hydromasážní tryska pro předvyrobené bazény   Hydromassage nozzle for prefabricated pools					cena Kč	€
31318	A	Hydromasážní tryska ABS, směrová Hydromassage nozzle ABS, directional		1	0,40	1 240,-
31319	A	Hydromasážní tryska ABS, rotační Hydromassage nozzle ABS, twisting		1	0,40	1 460,-

### Rotační tryska VA

- Hydromasážní rotační tryska
- Efektivní masáž
- Závit 1½" Ext.

### Rotary nozzle VA

- Hydromassage rotary nozzle
- Effective massage
- Thread 1½" Ext.



31314WH



31314LG



31314DG

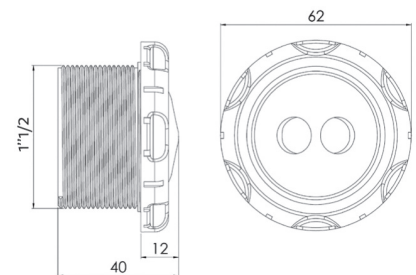

313120 ... - pro fólii / for liner  
313123 ... - pro předvyrobené / for prefabricated



313121 ... - pro fólii / for liner  
313124 ... - pro předvyrobené / for prefabricated



313122 ... - pro fólii / for liner  
313125 ... - pro předvyrobené / for prefabricated

Rotační masážní tryska VA   Rotary massage nozzle VA					cena Kč	€	
31314WH	B	Rotační část masážní trysky - Bílá Rotary part of the massage nozzle VA - White			1	0,15	2 407,-
31314LG	B	Rotační část masážní trysky - Světlé šedá Rotary part of the massage nozzle VA - Light gray			1	0,15	2 407,-
31314DG	B	Rotační část masážní trysky - Tmavě šedá Rotary part of the massage nozzle VA - Dark gray			1	0,15	2 407,-

Rotační masážní tryska VA - KIT   Rotary massage nozzle VA - KIT					cena Kč	€		
		Type of pool						
		Liner	Prefabr.					
313120	B	KIT - Rotační masážní tryska VA - bílá, pro fóliové bazény KIT - Rotary massage nozzle VA - white, for liner pools	✓		1	0,75	4 260,-	
313121	B	KIT - Rotační masážní tryska VA - světlé šedá, pro fóliové bazény KIT - Rotary massage nozzle VA - light grey, for liner pools	✓		1	0,75	4 387,-	
313122	B	KIT - Rotační masážní tryska VA - tmavě šedá, pro fóliové bazény KIT - Rotary massage nozzle VA - dark grey, for liner pools	✓		1	0,75	4 387,-	
313123	B	KIT - Rotační masážní tryska VA - bílá, pro předvyrobené bazény KIT - Rotary massage nozzle VA - white, for prefabricated pools		✓		1	0,75	3 628,-
313124	B	KIT - Rotační masážní tryska VA - světlé šedá, pro předvyrobené bazény KIT - Rotary massage nozzle VA - light grey, for prefabricated pools		✓		1	0,75	3 755,-
313125	B	KIT - Rotační masážní tryska VA - tmavě šedá, pro předvyrobené bazény KIT - Rotary massage nozzle VA - dark grey, for prefabricated pools		✓		1	3 755,-	

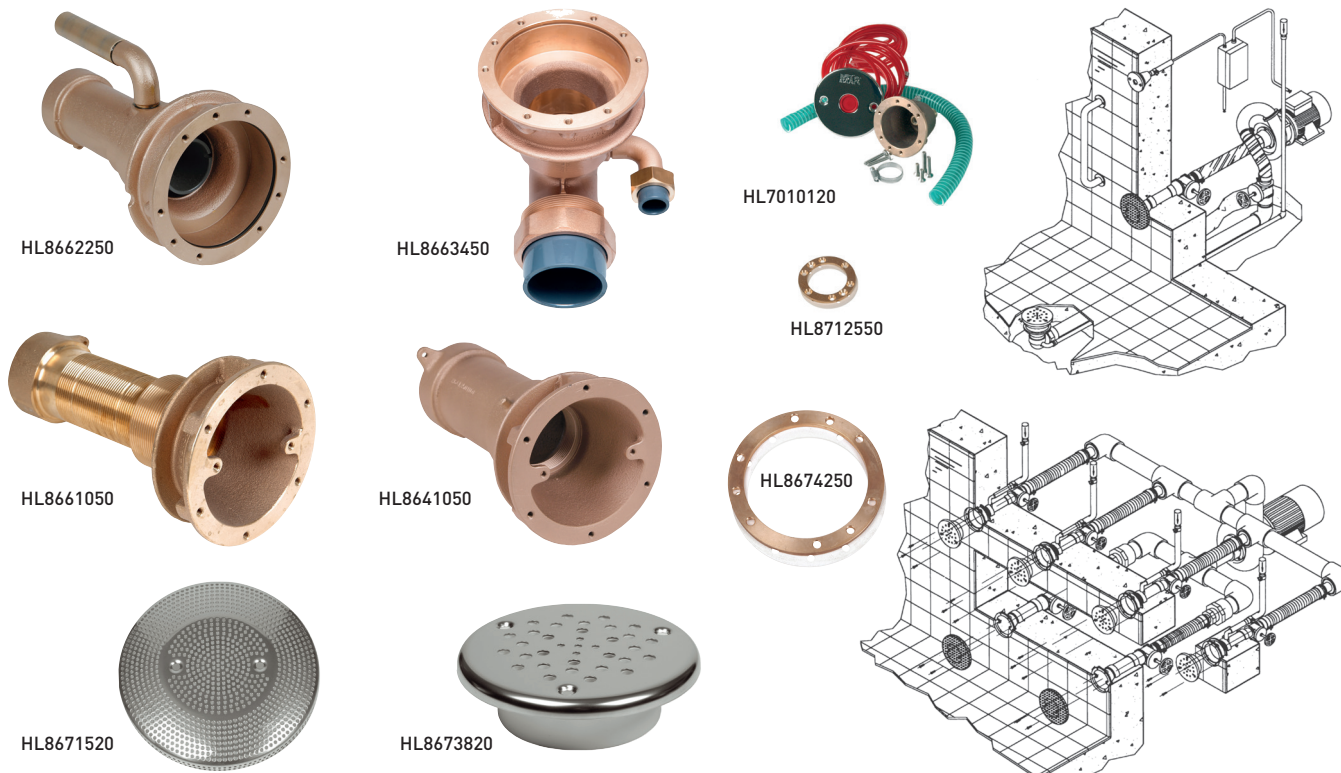

Hydromasážní tryska   Hydro massage nozzle				cena Kč	€
HL8662250	D Hydromasážní tryska s přísávaním vzduchu, hloubka 240 mm, napojení 2" int. a 1/2" int. Hydromassage nozzle with air intake, depth 240 mm, connection 2" int. and 1/2" int.		1	1,5	9 625,-
HL8663450	D Hydromasážní tryska 90° s přísávaním vzduchu, napojení d 63 mm a d 20 mm Hydromassage nozzle 90° with air intake connection d 63 mm and d 20 mm		1	0,9	10 611,-
HL8673820	D Kryt masážní trysky s 8 mm vyvrtanými otvory pro 8662250 a 8663450 Covering of hydro massage nozzle with 8 mm drilled holes for 8662250 and 8663450		1	0,2	4 190,-
HL8661050	D Sání hydromasáže, hloubka 240 mm, napojení 2" int. Suction of massage nozzle, depth 240 mm, connection 2" int.		1	5,0	6 740,-
HL8641050	D Sání hydromasáže, hloubka 240 mm, napojení 2 1/2" int. Suction of massage nozzle, depth 240 mm, connection 2 1/2" int.		1	4,2	7 312,-
HL8671520	D Kryt sání Ø 200 mm pro 8661050 a 8641050 Covering of suction Ø 200 mm for 8661050 and 8641050		1	0,3	2 792,-
HL8674250	D Přírubová sada k hydromasáži 8661050, 8641050, 8662250 a 8663450 Flange set for massage nozzle 8661050, 8641050, 8662250 and 8663450		1	0,5	1 169,-
HL7010120	D Pneumatický spínač pro vzduchovou masáž Pneumatic switch for air massage		1	1,4	6 923,-
HL8712550	D Přírubová sada pro piezo elektrický spínač Flange set for piezo electric switch		1	0,2	1 046,-



Hydromasážní tryska   Hydro massage nozzle				cena Kč	€
HL8669850	D Průchod stěnou 1 1/2" int. pro hydromasážní trysku - hloubka 240 mm, napojení 1" int. a 1/2" int. Poolwall lead-through 1 1/2" int. for hydro massage nozzle - depth 240 mm, connection 1" int. and 1/2" int.		1	2,7	6 619,-
HL8669220	D Tryska s jedním otvorem - závit 1 1/2" ext. Nozzle with one opening - thread 1 1/2" ext.		1	0,3	3 008,-
HL8669420	D Tryska s více otvory - závit 1 1/2" ext. Nozzle with multiple openings - thread 1 1/2" ext.		1	0,4	3 438,-
HL8669550	D Přírubová sada pro průchod stěnou 8669850 Flange set for poolwall lead-through 8669850		1	0,5	641,-

**Odstředivé pumpy EVOLUX**

jsou navrženy pro instalace do hydromasážních systémů.

- Tělo pumpy je z polypropylénu
- Krytí motoru: IP44
- Napojení: 50 mm
- Hlučnost: 70 dB

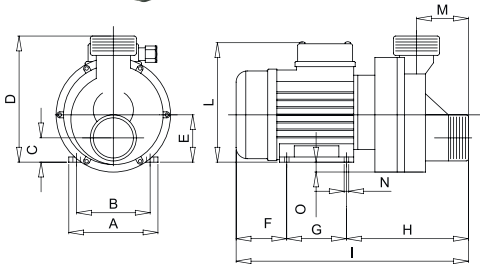
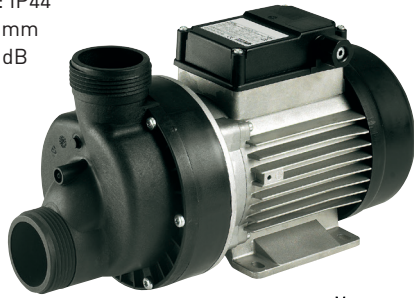
**Centrifugal swimming pool pumps EVOLUX**

are designed for hydromassage systems.

- Body of the pump is made of polypropylene
- Protection of engine: IP44
- Connection: 50 mm
- Noise level: 70 dB

**Průtok m³/h | Flow m³/h**

	4 m	6 m	8 m	10 m	12 m
EVOLUX 700	12,8	9,8	6,0	1,6	
EVOLUX 1000	15,2	12,0	8,2	3,4	
EVOLUX 1500		17,6	14,4	9,4	0,8
EVOLUX 2000			16,6	12,2	5,0

	A	B	C	D	E	F	G	H	I	L	M	N	O
EVOLUX 700	119	99	32,7	169	63	68	80	135	313	157	72	6,2	14
EVOLUX 1000	119	99	32,7	169	63	68	80	135	313	157	72	6,2	14
EVOLUX 1500	135	112	38	178	71	75	90	175	340	177	72	7,0	8
EVOLUX 2000	135	112	38	178	71	75	90	175	340	177	72	7,0	8

**Masážní pumpa | Massage pump**

3400700	B	Pumpa EVOLUX 700, 19,2 m³/h, 230 V, 0,55 kW – napojení 50 mm Pump EVOLUX 700, 19,2 m³/h, 230 V, 0,55 kW – connection 50 mm		1	7,90	6 739,-			
3401000	B	Pumpa EVOLUX 1000, 22,6 m³/h, 230 V, 0,75 kW – napojení 50 mm Pump EVOLUX 1000, 22,6 m³/h, 230 V, 0,75 kW – connection 50 mm		1	8,10	7 575,-			
3401500	B	Pumpa EVOLUX 1500, 25,5 m³/h, 230 V, 0,90 kW – napojení 50 mm Pump EVOLUX 1500, 25,5 m³/h, 230 V, 0,90 kW – connection 50 mm		1	8,30	9 051,-			
3402000	B	Pumpa EVOLUX 2000, 28,4 m³/h, 230 V, 1,10 kW – napojení 50 mm Pump EVOLUX 2000, 28,4 m³/h, 230 V, 1,10 kW – connection 50 mm		1	8,50	10 822,-			



Pumpu nelze použít pro slanou a mořskou vodu.

Not suitable for use in saltwater/seawater.

**Odstředivé pumpy CALA**

jsou navrženy pro instalace do hydromasážních systémů.

- Tělo pumpy je z polypropylénu
- Krytí motoru: IP55
- Napojení: 63 mm
- Hlučnost: 70 dB

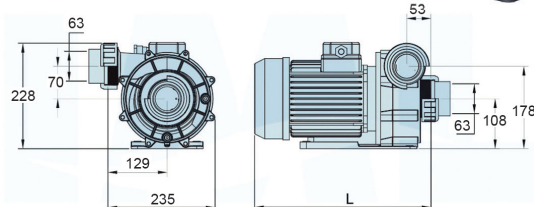

	L
CALA 200	365
CALA 300	385
CALA 450	415

**Centrifugal swimming pool pumps CALA**

are designed for hydromassage systems.

- Body of the pump is made of polypropylene
- Protection of engine: IP55
- Connection: 63 mm
- Noise level: 70 dB

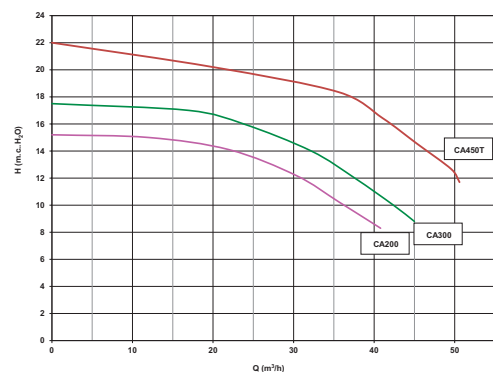
**Masážní pumpa | Massage pump**

34CA200M	B	Pumpa CALA 200M, 35,6 m³/h, 230 V, 1,50 kW – napojení 63 mm Pump CALA 200M, 35,6 m³/h, 230 V, 1,50 kW – connection 63 mm		1	16,5	12 023,-		
34CA300M	B	Pumpa CALA 300M, 40,8 m³/h, 230 V, 2,20 kW – napojení 63 mm Pump CALA 300M, 40,8 m³/h, 230 V, 2,20 kW – connection 63 mm		1	19,5	13 342,-		
34CA300T	B	Pumpa CALA 300T, 40,8 m³/h, 400 V, 2,20 kW – napojení 63 mm Pump CALA 300T, 40,8 m³/h, 400 V, 2,20 kW – connection 63 mm		1	19,5	13 031,-		
34CA450T	B	Pumpa CALA 450T, 55,4 m³/h, 400 V, 3,30 kW – napojení 63 mm Pump CALA 450T, 55,4 m³/h, 400 V, 3,30 kW – connection 63 mm		1	22,5	19 547,-		



Pumpu lze použít pro slanou a mořskou vodu.

Suitable for use in saltwater/seawater.