

Schwimmbadbeleuchtung	70	Rasvjeta za bazene	70
Schwimmbadbeleuchtung Adagio Pro	78	Rasvjeta za bazene Adagio Pro	78
Schwimmbadbeleuchtung MTS	80	Rasvjeta za bazene MTS	80
Sicherheitstransformatoren	81	Sigurnosni transformatori	81
Zubehör	82	Oprema	82
Schwimmbadbeleuchtung Hugo Lahme	83	Rasvjeta za bazene Hugo Lahme	83
Schwimmbadbeleuchtung	84	Rasvjeta za bazene	84

4

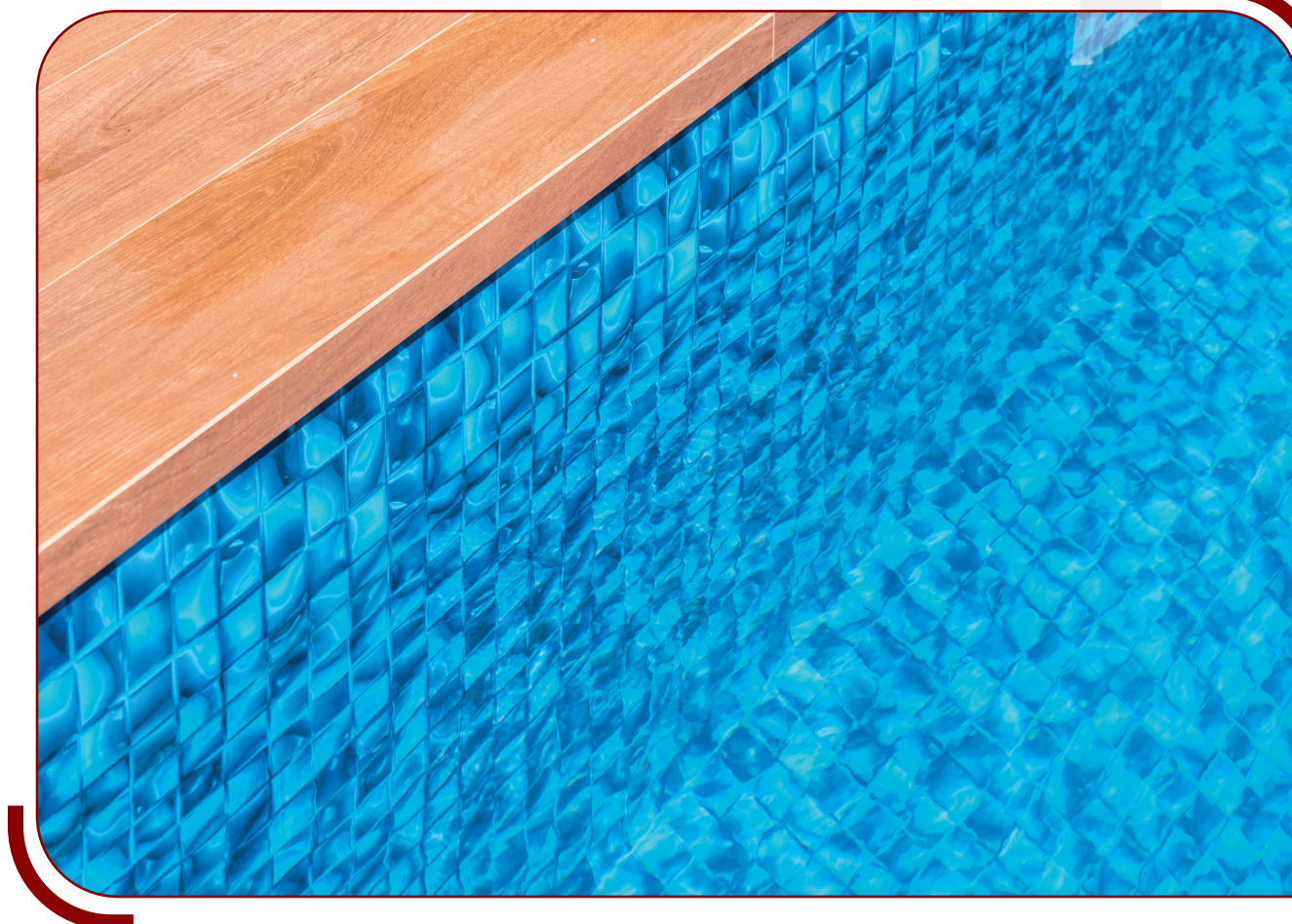

KIT für Installation von Lichtern – Folienbecken

- Dieses KIT ist für verschiedene Lichtarten konzipiert – genauer für Lichter, die eine R1-Installation haben. Ext Gewinde
- Kann sowohl für Folien-/Betonbecken als auch für Fertigbecken verwendet werden

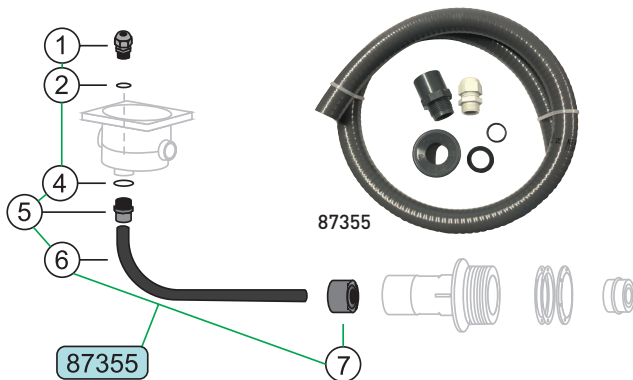

KIT za instalaciju rasvjetnih tijela – za folijske bazene

- Ovaj KIT je dizajniran za korištenje kod različitih vrsta svjetala – točnije za svjetla koja imaju instalaciju R 1. Vanjski navoj
- Može se koristiti i za folijske/betonske bazene i za montažne bazene

N°	REF	Product description
1	5209013	Entrance PG 13,5 grey
2	5191301903	Flat sealing (30 x 20 x 3)
3	873495V	Cable interconnecting box VA
3	873495	Cable interconnecting box HAYWARD-COFFIES
4	51901825	O-ring 18 x 2,5 mm for glove finger/fl. switch
5	02036025041	Adapter 32–25 x 3/4" Ext. modified
6	0317643025	PVC hose PVC 25 mm Ex
7	0225605025	Reduction – short 50–25 mm



Abzweigdosenet für Unterwasserlichter | Komplet razvodne kutije za rasvjetno tijelo

87355	B	Abzweigdosenet für Unterwasserlichter Komplet razvodne kutije za rasvjetno tijelo			Price
				1	0,3

Lichteinbau in VA / VAMILA-Düse

- Für Lichter mit R1. Ext-Gewinde haben wir im Angebot speziell angepasste Düsen VA und VAMILA
- Falls Sie sich für die Installation des Lichts in der VA-Düse entscheiden, können Sie aus 3 Farbvarianten wählen: Weißes ABS/Hellgrau/Dunkelgrau
- VAMILA Grundelement ist für Fertigbecken bestimmt. Für den Einsatz in Folienbecken ist es notwendig, den Flanschsetz 3575 zu kaufen.

Für Fertigbecken / Za kompozitne bazene



3131451

3131454

3131455

Für Folienbecken / Za folijske bazene



3131453

3131457

3131458

Instalacija svjetla u mlaznicu VA / VAMILA

- Za svjetla s R 1" vanjskim navojem nudimo posebno modificirane VA i VAMILA mlaznice
- Ako se odlučite za ugradnju svjetla u VA mlaznicu, možete birati između 3 varijante boja: Bijela ABS/Svijetlo siva/Tamno siva
- Osnovni element VAMILA namijenjen je za montažne bazene. Za korištenje na bazenima od folije potrebno je kupiti set prirubnica 3575.

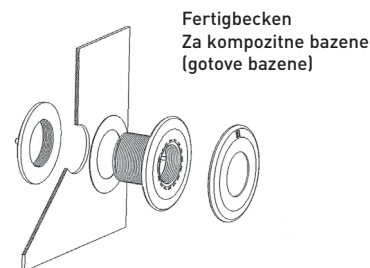

Für Grundelement VAMILA
Za osnovni element VAMILA



3575

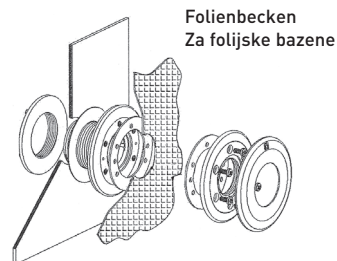

85032

Liner	Prefabricated	Zubehör Pribor			Price	Price
3131453	3131451	VA-Düse – gedreht für Licht 1 1/2" – weiß ABS Mlaznica VA – obradena za svjetla 1 1/2" – bijela ABS		1	0,30	
3131457	3131454	VA-Düse – gedreht für Licht 1 1/2" – hellgrau Mlaznica VA – obradena za svjetla 1 1/2" – svijetlo siva		1	0,30	
3131458	3131455	VA-Düse – gedreht für Licht 1 1/2" – dunkelgrau Mlaznica VA – obradena za svjetla 1 1/2" – tamno siva		1	0,30	
	85032A	Grundelement VAMILA für Licht 1 1/2" VAMILA osnovni element za svjetla 1 1/2"		1	0,30	

LED Schwimmbadbeleuchtung SeaMAID Mini-Tube

- RGB; max. 320 lm, 9 LED, 8,2 W, 50 mm; 1,5" ext.
- Weiß; 630 lm, 18 LED, 6 W, 50 mm; 1,5" ext.
- Einbau in Düsen
- Lichtkonus 120°
- Kabel 2 m
- RGB – 11 statische Farben und 5 Programme

LED rasvjete za bazene SeaMAID Mini-Tube

- RGB; maks. 320 lm, 9 LED, 8,2 W, 50 mm; 1,5" ext.
- Bijelo; 630 lm, 18 LED, 6 W, 50 mm; 1,5" ext.
- Ugradnja u mlaznicu
- Kut difuzije svjetla 120°
- Kabel 2 m
- RGB – 11 statičnih boja i 5 programa

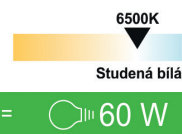
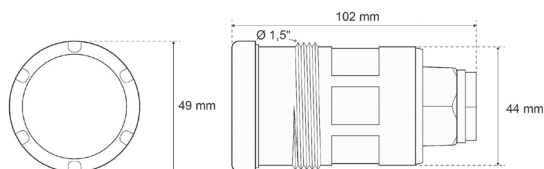

LED Schwimmbadbeleuchtung SeaMAID Mini-Tube LED rasvjete za bazene SeaMAID Mini-Tube		Box	KG	Price
81502778	Schwimmbadbeleuchtung SeaMAID MINI-Tube, 18 LED weiß, 6 W/12 V, 630 lm, 50 mm; 1,5" ext. Rasvjete za bazene SeaMAID MINI-Tube, 18 LED bijelo, 6 W/12 V, 630 lm, 50 mm; 1,5" ext.		12	0,58
81502785	Schwimmbadbeleuchtung SeaMAID MINI-Tube, 9 LED RGB, 8,2 W/12 V, 320 lm, 50 mm; 1,5" ext. Rasvjete za bazene SeaMAID MINI-Tube, 9 LED RGB, 8,2 W/12 V, 320 lm, 50 mm; 1,5" ext.		12	0,58

		LED MINI TUBE		Düsenfarbe / Boja mlaznica				Type of pool		Box	KG	Price
		White	RGB	White	Light grey	Dark grey	VAMILA	Liner	Prefabr.			
85133W	9 LED, 6 W, 630 lm			○				✓			1	
85134W	9 LED, 6 W, 630 lm				○			✓			1	
85135W	9 LED, 6 W, 630 lm					●		✓			1	
85133R	18 LED, 8,2 W, 320 lm			○				✓			1	
85134R	18 LED, 8,2 W, 320 lm				○			✓			1	
85135R	18 LED, 8,2 W, 320 lm					●		✓			1	
85033W	9 LED, 6 W, 630 lm			○					✓		1	
85034W	9 LED, 6 W, 630 lm				○				✓		1	
85035W	9 LED, 6 W, 630 lm					●			✓		1	
85033R	18 LED, 8,2 W, 320 lm			○					✓		1	
85034R	18 LED, 8,2 W, 320 lm				○				✓		1	
85035R	18 LED, 8,2 W, 320 lm					●			✓		1	
85032W	9 LED, 6 W, 630 lm						AISI 316		✓		1	
85032R	18 LED, 8,2 W, 320 lm						AISI 316		✓		1	

LED Schwimmbadbeleuchtung SeaMAID Mini

- Transparentes Polycarbonat-Gehäuse
- 2-m-Kabel ist im Lieferumfang enthalten
- Einbau 1,5" ext.
- RGB – 11 statische Farben und 5 Programme



8550859

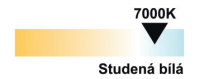
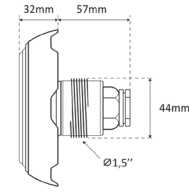
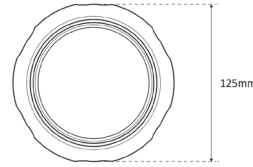

6 W = 60 W

LED Schwimmbadbeleuchtung SeaMAID Mini LED rasvjete za bazene SeaMAID Mini				Price
8550866	Schwimmbadbeleuchtung SeaMAID Mini, 36 LED RGB, 7 W/12 V, 222 lm Rasvjete za bazene SeaMAID Mini, 36 LED RGB, 7 W/12 V, 222 lm			1 0,60
8550859	Schwimmbadbeleuchtung SeaMAID Mini, 12 LED weiß, 5,2 W/12 V, 540 lm, 7 500 K Rasvjete za bazene SeaMAID Mini, 12 LED bijelo, 5,2 W/12 V, 540 lm, 7 500 K			1 0,60

LED Schwimmbadbeleuchtung SeaMAID, flach

- 2-m-Kabel ist im Lieferumfang enthalten
- Einbau 1,5" Außengewinde
- RGB – 11 statische Farben und 5 Programme



85501191



85501160

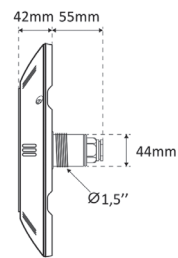
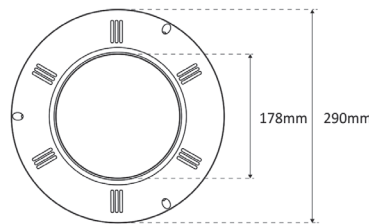

13,5 W = 135 W

LED Schwimmbadbeleuchtung SeaMAID LED rasvjete za bazene SeaMAID				Price
85501191	Schwimmbadbeleuchtung SeaMAID, flach, 90 LED RGB, 16 W/12 V, 510 lm Rasvjete za bazene SeaMAID, ravno, 90 LED RGB, 16 W/12 V, 510 lm			1 1,5
85501160	Schwimmbadbeleuchtung SeaMAID, flach, 60 LED weiß, 13,5 W/12 V, 1 650 lm Rasvjete za bazene SeaMAID, ravno, 60 LED bijelo, 13,5 W/12 V, 1 650 lm			1 1,5



81501801



81501474



81501412

Zubehör Oprema				Price
81501801	Fernbedienung SeaMAID – 1 Kanal Daljinsko upravljanje SeaMAID – jednokanalno			1 0,50
81501474	Mini-Fernbedienung zur Fernsteuerung SeaMAID On/Off Mini daljinski upravljač za daljinsko upravljanje SeaMAID On/Off			1 0,10
81501412	Antenne – Verstärkung der Reichweite des Funksignals Antena – pojačavanje dometa radijskog signala			1 0,50

LED Schwimmbadbeleuchtung Horizont

- Dieses schwimmbadbeleuchtung wird mit Fassung geliefert
- Das Paket enthält ein 4-Meter-Kabel
- Einbau 1,5" Außengewinde

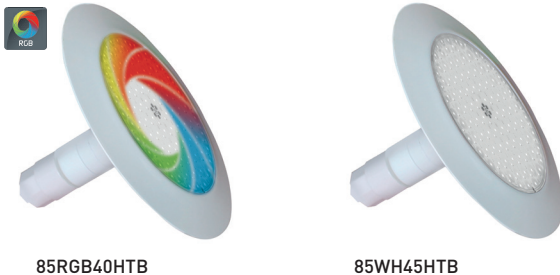

85RGB40HTB

85WH45HTB

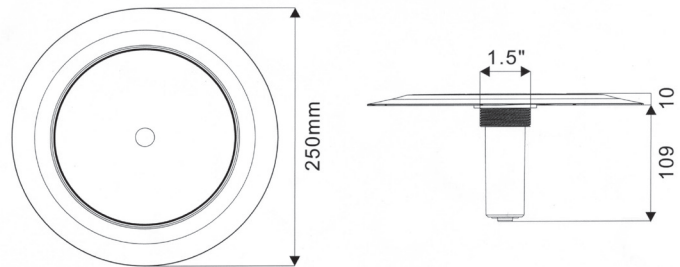

LED rasvjete za bazene Horizont

- Rasvjete za bazene isporučuje s okvirom
- Dolazi u paketu s kablom duljine 4 metra
- Ugradnja 1,5" vanjski navoj

LED Schwimmbadbeleuchtung Horizont LED rasvjete za bazene Horizont		📦	⚖️ KG	Price
85RGB40HTB	Schwimmbadbeleuchtung Horizont, 630 LED RGB, 30 W/12 V, 2 000 lm Rasvjete za bazene Horizont, 630 LED RGB, 30 W/12 V, 2 000 lm			1, 1,4
85WH45HTB	Schwimmbadbeleuchtung Horizont, 630 LED biĉe, 33 W/12 V, 4 500 lm, 6 500 K Rasvjete za bazene Horizont, 630 LED bijelo, 33 W/12 V, 4 500 lm, 6 500 K			1, 1,4

Mini LED Schwimmbadbeleuchtung ZODIAC

- 9 statische Farben
- 5 im Voraus eingestellte Farbschemas
- Farbwechsel:
Manuell: EIN/AUS Ferngesteuert
(Verbindung mit der PlattformExo® iQ)
- Kabellänge: 3 m



Mini LED rasvjete za bazene ZODIAC

- 9 statičnih boja
- 5 unaprijed postavljenih shema boja
- Promjena boje:
Ručno: ON/OFF
Na daljinu (spajanje s Exo® iQ)
- Duljina kabela: 3 m



Inklusive weißer und grauer Frontabdeckung
Bijeli i sivi okvir su uključeni u pakiranje

Mini LED Schwimmbadbeleuchtung ZODIAC Mini LED rasvjete za bazene ZODIAC		📦	⚖️ KG	Price
8WT000233	Schwimmbadbeleuchtung ZODIAC RGBW, 6 W, 160 lm – 1,5" ext. Rasvjete za bazene ZODIAC RGBW 6 W, 160 lm – 1,5" ext.			1, 0,90
8WT000234	Schwimmbadbeleuchtung ZODIAC RGBW 12 W, 340 lm – 1,5" ext. Rasvjete za bazene ZODIAC RGBW 12 W, 340 lm – 1,5" ext.			1, 1,00
8WT000235	Schwimmbadbeleuchtung ZODIAC RGBW 24 W, 505 lm – 1,5" ext. Rasvjete za bazene ZODIAC RGBW 24 W, 505 lm – 1,5" ext.			1, 1,00

Schwimmbadbeleuchtung VA weiß, 50 W

- Farbe: weiß
- Leistung: 50 W/12 V

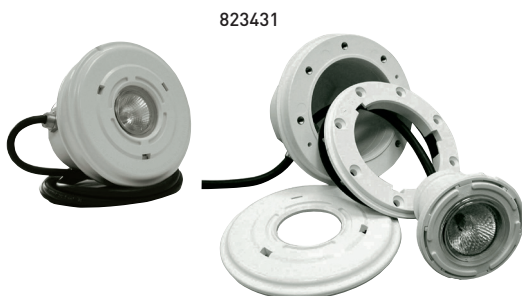

823431

Rasvjete za bazene VA bijelo, 50 W

- Boja: bijela
- Snaga: 50 W/12 V

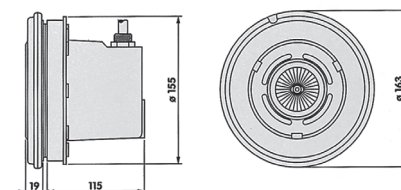

Schwimmbadbeleuchtung VA Rasvjete za bazene VA		📦	⚖️ KG	Price
823431	Schwimmbadbeleuchtung VA 50 W, weiß, mit Anschlussdose und Flansch, für Folienpools Rasvjetno tijelo VA 50 W, bijelo, s priključnom kutijom i prirubnicom, za folijske bazene			4, 1,5

Renovierungs-Kit für Unterwasserlichter



81502372



81502374



81502375

81512372

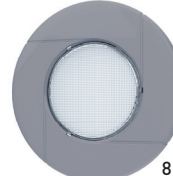
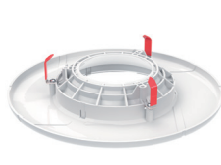

81512374

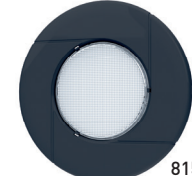

81512375

Zubehör | Oprema

Zubehör Oprema				Price
81502372	Reparatursatz für Beleuchtung, Leuchtmittel 300 W – weiße Fassung Kit za renoviranje rasvjetnog tijela, svjetlo 300 W – bijeli okvir		1	0,30
81502374	Reparatursatz für Beleuchtung, Leuchtmittel 300 W – hellgraue Fassung Kit za renoviranje rasvjetnog tijela, svjetlo 300 W – svijetlosivi okvir		1	0,30
81502375	Reparatursatz für Beleuchtung, Leuchtmittel 300 W – dunkelgraue Fassung Kit za renoviranje rasvjetnog tijela, svjetlo 300 W – tamnosivi okvir		1	0,30
81512372	Set „Click“ für die Renovierung des 300W-Lichts – weißer Rahmen Komplet „Click“ za reparaciju 300W svjetla – bijeli okvir		1	0,30
81512374	Set „Click“ für die Renovierung des 300W-Lichts – hellgrauer Rahmen Komplet „Click“ za reparaciju 300W svjetla – svijetlo sivi okvir		1	0,30
81512375	Set „Click“ für die Renovierung des 300W-Lichts – dunkelgrauer Rahmen Komplet „Click“ za reparaciju 300W svjetla – tamno sivi okvir		1	0,30

„Satz zur Anpassung des Unterwasserlichts“ inkl. Fassung, Schrauben und Metallverbinder.

„Kit za renoviranje rasvjetnog tijela“ sadrži okvir, vijke i metalne kopče.

Glühlampe LED SeaMAID

- RGB – 11 statische Farben und 5 Programme
- Kompatibel mit dem „Renovierungs-Kit“



81502655



81502679

Die Kabeleinführung wird mitgeliefert
Uvodnica za kabel dio je pakiranja

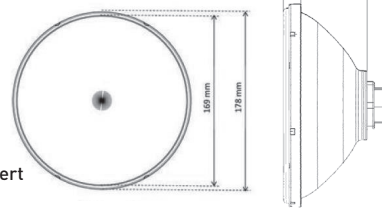

6500K
Studená bílá

13,5 W = 135 W

Glühlampe LED SeaMAID | Žarulja LED SeaMAID

Glühlampe LED SeaMAID Žarulja LED SeaMAID				Price
81502655	LED SeaMAID, PAR 56, 90 LED RGB, 16 W, 510 lm, mit Kabeleinführung LED SeaMAID, PAR 56, 90 LED RGB, 16 W, 510 lm, s uvodnicom za kabel		6	0,70
81502679	LED, SeaMAID, PAR 56, 60 LED weiß, 13,5 W, 1 650 lm, mit Kabeleinführung LED SeaMAID, PAR 56, 60 LED bijelo, 13,5 W, 1 650 lm, s uvodnicom za kabel		6	0,70

Glühlampe LED-IN SeaMAID

- RGB – 11 statische Farben und 5 Programme
- Kann durch die Lampe 300 W PAR56 ersetzt werden



81501535



81501542

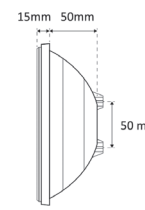
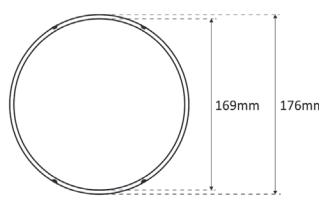

6500K
Studená bílá

13,5 W = 135 W

Glühlampe LED IN | Žarulja LED IN

Glühlampe LED IN Žarulja LED IN				Price
81501535	LED IN, PAR 56 flaches Licht, 90 LED RGB, 16 W/12 V, 510 lm LED IN, PAR 56 ravno staklo, 90 LED RGB, 16 W/12 V, 510 lm		6	0,95
81501542	LED IN, PAR 56 flaches Licht, 60 LED weiß, 13,5 W/12 V, 1 650 lm LED IN, PAR 56 ravno staklo, 60 LED bijelo, 13,5 W/12 V, 1 650 lm		6	0,95

LED Schwimmbadbeleuchtung Flat

- LED-Schwimmbadbeleuchtung
- Kompatibel mit der Lampe 300W (austauschbar)
- RGB – 16 statische Farben
- 4m Kabel



LED rasvjete za bazene Flat

- LED rasvjeta za bazene
- Kompatibilno sa žaruljom 300W (može se zamijeniti)
- RGB – 16 statičnih boja
- Kabel od 4m

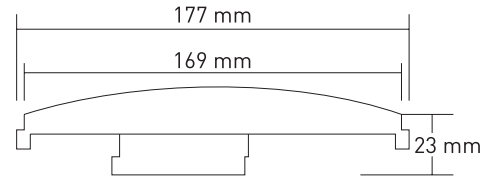

LED Schwimmbadbeleuchtung Flat RGB LED rasvjete za bazene Flat RGB						📦	🏋️	Price
81HTS301B	LED Flat 300, 324 LED RGB, 23 W/12 V, max. Stromverbrauch 23 W, 1 150 lm LED Flat 300, 324 LED RGB, 23 W/12 V, maks. potrošnja 23 W, 1 150 lm				6	0,60		
81HTS701B	LED Flat 700, 531 LED RGB, 33 W/12 V, max. Stromverbrauch 33 W, 1 650 lm LED Flat 700, 531 LED RGB, 33 W/12 V, maks. potrošnja 33 W, 1 650 lm				6	0,60		

LED Schwimmbadbeleuchtung Flat, weiß LED rasvjete za bazene Flat, bijelo						📦	🏋️	Price
81HTW301B	LED Flat 300, 252 LED weiß, 21 W/12 V, max. Stromverbrauch 21 W, 2 100 lm, 6 500 K LED Flat 300, 252 LED bijelo, 21 W/12 V, maks. potrošnja 21 W, 2 100 lm, 6 500 K			6	0,60			
81HTW701B	LED Flat 700, 432 LED weiß, 33 W/12 V, max. Stromverbrauch 33 W, 3 300 lm, 6 500 K LED Flat 700, 432 LED bijelo, 33 W/12 V, maks. potrošnja 33 W, 3 300 lm, 6 500 K			6	0,60			

LED Schwimmbadbeleuchtung Flat – DMX

- LED Schwimmbadbeleuchtung
- Kompatibel mit 300W Glühbirne (austauschbar)
- RGB – 16 statische Farben
- DMX-Kommunikation (intelligente Lichtsteuerung)
- 4m Kabel



VARIO

LED rasvjete za bazene Flat – DMX

- LED rasvjete za bazene
- Kompatibilno sa žaruljom od 300 W (može se zamijeniti)
- RGB – 16 statičnih boja
- DMX komunikacija (inteligentna kontrola svjetla)
- Kabel od 4m

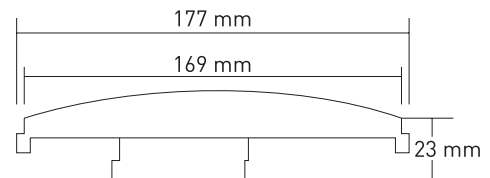

DMX protocol

Kann mit dem VARIO DIN LIGHTS Modul verbunden und gesteuert werden
Može se spojiti i kontrolirati pomoću VARIO DIN LIGHTS modula

LED Flat DMX – RGB LED Flat DMX – RGB						📦	🏋️	Price
81HTX301B	LED Flat 300 DMX, 324 LED RGB, 23 W/12 V, max. Leistung 23 W, 1 150 lm LED Flat 300 DMX, 324 LED RGB, 23 W/12 V, maks. potrošnja 23 W, 1 150 lm					6	0,60	
81HTX701B	LED Flat 700 DMX, 531 LED RGB, 33 W/12 V, max. Leistung 33 W, 1 650 lm LED Flat 700 DMX, 531 LED RGB, 33 W/12 V, maks. potrošnja 33 W, 1 650 lm					6	0,60	
81HTX901B	LED Flat 900 DMX, 630 LED RGB, 55 W/12 V, max. Leistung 55 W, 2 750 lm LED Flat 900 DMX, 630 LED RGB, 55 W/12 V, maks. potrošnja 55 W, 2 750 lm					6	0,60	



81PLSREM

Fernbedienung Daljinsko upravljanje						📦	🏋️	Price
81PLSREM	Fernbedienung + 1 Mini-Fernbedienung für Licht Flat Daljinsko upravljanje + 1 mini daljinski upravljač za svjetla Flat		1	0,5				

Kann durch die Lampe 300 W PAR56 ersetzt werden

Moguće je zamijeniti žaruljom 300 W PAR56

Schwimmbadbeleuchtung Hayward

- Für Folienpools – umfasst Flansche und zwei Dichtungen
- Schutzschlauch für Stromkabel
- Selbstschneidende Schrauben
- Kabel 3 m

Rasvjete za bazene Hayward

- Za folijske bazene – uključuje prirubnice i dvije brtve
- Zaštitno crijevo električnog kabla
- Samorezni vijci
- Kabel 3 m

HAYWARD

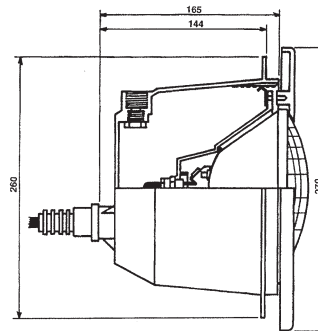

853481

Schwimmbadbeleuchtung Design | Rasvjete za bazene Design

853481	Schwimmbadbeleuchtung Design 300 W – für Folienpools Rasvjete za bazene Design 300 W – za folijske bazene	KG	Price
		3,0	

DESIGN LED	Glühbirne Žarulja	Farbe / Boja		Lichtstärke Iluminacija	Leistung Kapacitet	Spannung Napajanje	KG	Price
		White	RGB					
853481LED13W	LED – Original	☐		1 450 lm	13 W	12 V	3,0	
853481LED16W	LED PAR 56 – 81501542	☐		1 650 lm	13,5 W	12 V	3,0	
853481LED21W	LED Flat – 81HTW301B	☐		2 100 lm	21 W	12 V	3,0	
853481LED33W	LED Flat – 81HTW701B	☐		3 300 lm	33 W	12 V	3,0	
853481LED16R	LED PAR 56 – 81501535		☐	510 lm	16 W	12 V	3,0	
853481LED17R	LED – Original		☐	600 lm	16 W	12 V	3,0	
853481LED23R	LED Flat – 81HTS301B		☐	1 150 lm	23 W	12 V	3,0	
853481LED33R	LED Flat – 81HTS701B		☐	1 650 lm	33 W	12 V	3,0	

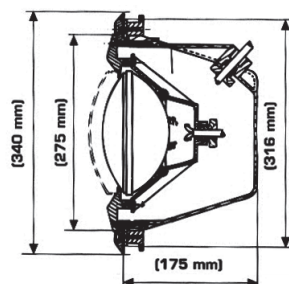

LED HAYWARD	Glühbirne Žarulja	Farbe / Boja		Lichtstärke Iluminacija	Leistung Kapacitet	Spannung Napajanje	KG	Price
		White	RGB					
840512LED16W	LED PAR 56 – 81501542	☐		1 650 lm	13,5 W	12 V	3,0	
840512LED16R	LED PAR 56 – 81501535		☐	510 lm	16 W	12 V	3,0	

Beim Einsatz von flachen LED-Lampen wird die Verwendung von Abstandshaltern empfohlen: 03016125480045

Kada koristite ravnu LED žarulju, preporučuje se uporaba držača razmaka: 03016125480045

Schwimmbadbeleuchtung VA

- Für Folienpools – umfasst Flansch und zwei Dichtungen
- Schutzschlauch für Stromkabel
- Edelstahl-Einsätze

Rasvjete za bazene VA

- Za folijske bazene – uključuje prirubnice i dvije brtve
- Zaštitno crijevo električnog kabela
- Umetci od nehrdajućeg čelika

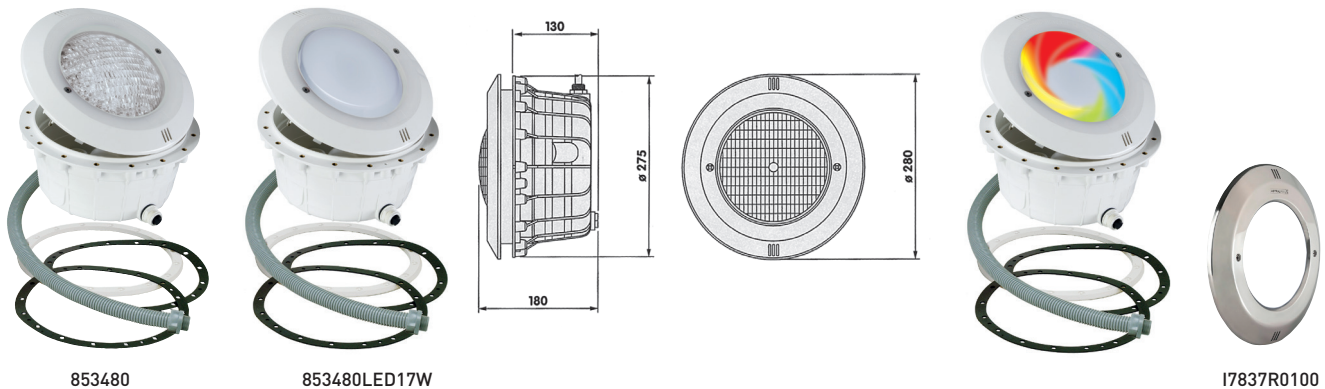

Schwimmbadbeleuchtung VA Rasvjete za bazene VA		KG	Price
853480	Schwimmbadbeleuchtung VA 300 W – für Folienpools Rasvjete za bazene VA 300 W – za folijske bazene	3,5	
17837R0100	Edelstahlfassung für Schwimmbadbeleuchtung VA 300 W Okvir od nehrdajućeg čelika, Rasvjete za bazene VA 300 W	0,5	

VA LED	Glühbirne Žarulja	Farbe / Boja		Lichtstärke Iluminacija	Leistung Kapacitet	Spannung Napajanje		KG	Price
		White	RGB						
853480LED16W	LED PAR 56 – 81501542	☐		1 650 lm	13,5 W	12 V		3,0	
853480LED17W	LED – Original	☐		1 458 lm	16 W	12 V		3,0	
853480LED21W	LED Flat – 81HTW301B	☐		2 100 lm	21 W	12 V		3,0	
853480LED33W	LED Flat – 81HTW701B	☐		3 300 lm	33 W	12 V		3,0	
853480LED16R	LED – Original		🌈	510 lm	16 W	12 V		3,0	
853480LED23R	LED Flat – 81HTS301B		🌈	1 150 lm	23 W	12 V		3,0	
853480LED33R	LED Flat – 81HTS701B		🌈	1 650 lm	33 W	12 V		3,0	

Schwimmbadbeleuchtung VA, flach

- Kabellänge 3 m
- Befestigung mithilfe eines tragbaren T-Form-Werkzeugs



Rasvjete za bazene VA, ravno

- Duljina kabela 3 m
- Učvršćivanje uz pomoć nosivog križa

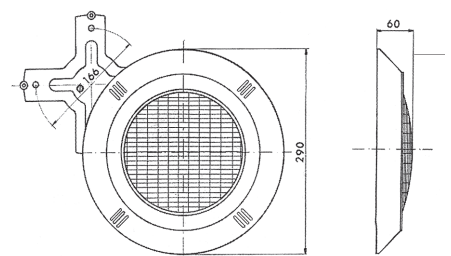

LED VA flach LED VA ravno	Glühbirne Žarulja	Farbe / Boja		Lichtstärke Iluminacija	Leistung Kapacitet	Spannung Napajanje		KG	Price
		White	RGB						
80500LED21W	LED Flat – 81HTW301B	☐		2 100 lm	21 W	12 V		3,0	
80500LED33W	LED Flat – 81HTW701B	☐		3 300 lm	33 W	12 V		3,0	
80500LED23R	LED Flat – 81HTS301B		🌈	1 150 lm	21 W	12 V		3,0	
80500LED33R	LED Flat – 81HTS701B		🌈	1 650 lm	33 W	12 V		3,0	

Beim Einsatz von flachen LED-Lampen wird die Verwendung von Abstandshaltern empfohlen: 03016125480045

Kada koristite ravnu LED žarulju, preporučuje se uporaba držača razmaka: 03016125480045

LED Schwimmbadbeleuchtung Adagio PRO

- Große Lichtintensität (weiß 2 600 do 5 500 lm, farbig 1 700 bis 3 000 lm)
- 3 Weiß-Nuancen: (sonnig-weiß, neutralweiß und warm-weiss - nur für RGB-Leuchten)
- 11 farbige Lichter
- 4 Meter langes Kabel wird mitgeliefert
- Einbau mithilfe eines Montageelements 1,5"
- Adagio 170 entspricht den Leuchtmitteln PAR56 (60 W, 75 W)
- Für die Speisung soll der Ringkerntransformator verwendet werden
- Der Überspannungsschutz wird empfohlen



85170RAWH



85170RASS



85WH60PRO



85RGB75PRO

Fassungen können beliebig miteinander kombiniert werden
Ovkiri se mogu proizvoljno kombinirati

LED Schwimmbadbeleuchtung Adagio PRO 170 kann durch die Lampe PAR56 300 W ersetzt werden.

LED rasvjete za bazene Adagio PRO

- Velik intenzitet svjetlosti (bijelo 2 600 do 5 500 lm, u boji 1 700 do 3 000 lm)
- 3 nijanse bijele: (sunčano bijela, neutralno bijela i i topla bijela - samo za RGB svjetla)
- 11 svjetala u boji
- Kabel duljine 4 metra uključen u rasvjetu
- Ugradnja uz pomoć montažnog elementa 1,5"
- Adagio 170 odgovara svjetlima PAR56 (60 W, 75 W)
- Za napajanje je potrebno koristiti toroidni transformator
- Preporučujemo uporabu zaštite od prenapona

LED rasvjete za bazene Adagio PRO 170 moguće je zamijeniti žaruljom PAR56, 300 W.

LED Schwimmbadbeleuchtung Adagio PRO 170 LED rasvjete za bazene Adagio PRO 170		📦	⚖️	Price
85WH60PRO	LED weißes Licht 60 W, Lichtintensität 5 500 lm, Ø 17 cm, 5 000 K LED bijelo svjetlo 60 W, intenzitet svjetlosti 5 500 lm, Ø 17 cm, 5 000 K		1	1,0
85RGB75PRO	LED RGB farbiges Licht 75 W, Lichtintensität 3 000 lm, Ø 17 cm LED RGB svjetlo u boji 75 W, intenzitet svjetlosti 3 000 lm, Ø 17 cm		1	1,0
85170RASS	Fassung des Unterwasserlichts aus Edelstahl, Ø 17/25 cm Ovkir za rasvjetno tijelo od nehrđajućeg čelika, Ø 17/25 cm		1	0,3
85170RAWH	Fassung des Unterwasserlichts weiß, Ø 17/25 cm Ovkir za rasvjetno tijelo, bijeli, Ø 17/25 cm		1	0,3



85100RAWH



85100RASS



85WH30PRO



85RGB45PRO

Fassungen können beliebig miteinander kombiniert werden
Ovkiri se mogu proizvoljno kombinirati

LED Schwimmbadbeleuchtung Adagio PRO 100 LED rasvjete za bazene Adagio PRO 100		📦	⚖️	Price
85WH30PRO	LED weißes Licht 30 W, Lichtintensität 2 600 lm, Ø 10 cm, 5 000 K LED bijelo svjetlo 30 W, intenzitet svjetlosti 2 600 lm, Ø 10 cm, 5 000 K		1	0,60
85RGB45PRO	LED RGB farbiges Licht, 45 W, Lichtintensität 1 700 lm, Ø 10 cm LED RGB svjetlo u boji, 45 W, intenzitet svjetlosti 1 700 lm, Ø 10 cm		1	0,60
85100RASS	Fassung des Unterwasserlichts aus Edelstahl, Ø 10/17,5 cm Ovkir rasvjetnog tijela od nehrđajućeg čelika, Ø 10/17,5 cm		1	0,3
85100RAWH	Fassung des Unterwasserlichts weiß, Ø 10/17,5 cm Ovkir rasvjetnog tijela bijeli, Ø 10/17,5 cm		1	0,3

Fernbedienung und Zubehör

- Dimmfunktion (Nur 81PLPREM)
- Möglichkeit der Anbindung an das System des „intelligenten Hauses“



81PLSREM / 81PLPREM



855130151

Daljinski upravljač i pribor

- Funkcija prigušivanja svjetla (Samo 81PLPREM)
- Mogućnost povezivanja sa sustavom „pametne kuće“



85WTMS

Zubehör Oprema		📦	⚖️	Price
81PLSREM	Fernsteuerung + 1 Mini-Fernsteuerung Daljinsko upravljanje + 1 mini daljinski upravljač		1	0,5
81PLPREM	Fernbedienung + Schlüsselanhänger (mit Dimmfunktion) Daljinsko upravljanje + mini upravljač (s funkcijom zatamnjivanja)		1	0,5
85WTMS	Montageelement mit Flansch für Folienpools Montažni element s priрубnicom za folijske bazene		1	0,5
855130151	Montageschlüssel für Montageelement Montažni ključ za montažni element		1	

Wie kann man den Transformator für Adagio Pro auswählen

Für LED Schwimmbadbeleuchtung Adagio PRO soll der Ringkerntransformator verwendet werden.
Trafostation für Adagio PRO – wenn jede Lampe mit eigener Leitung/ eigenem Kabel an den Transformator angeschlossen ist.

Kako odabrati transformator za Adagio Pro

Za LED rasvjete za bazene Adagio PRO potrebno je koristiti toroidni transformator.
Transformatorska stanica za Adagio PRO – ako je svaka žarulja spojena na transformator s vlastitim vodičem/ kablom.

Trafostation für Schwimmbadbeleuchtung Adagio PRO | Transformator za rasvjete za bazene Adagio PRO

Beleuchtungsart Vrsta rasvjete		Draht-/Leiterquerschnitt Poprečni presjek žice/vodiča					Art der Trafostation Model transformatora	KG	Price
		1,5 mm ²	2,5 mm ²	4,0 mm ²	6,0 mm ²	10,0 mm ²			
85WH30PRO	B	21 m	35 m	57 m	85 m	142 m	50 W		
85RGB45PRO	B	12 m	20 m	33 m	50 m	80 m	50 W		
85WH60PRO	B	4 m	7 m	11 m	16 m	28 m	100 W		
85RGB75PRO	B	6 m	10 m	16 m	25 m	42 m	100 W		

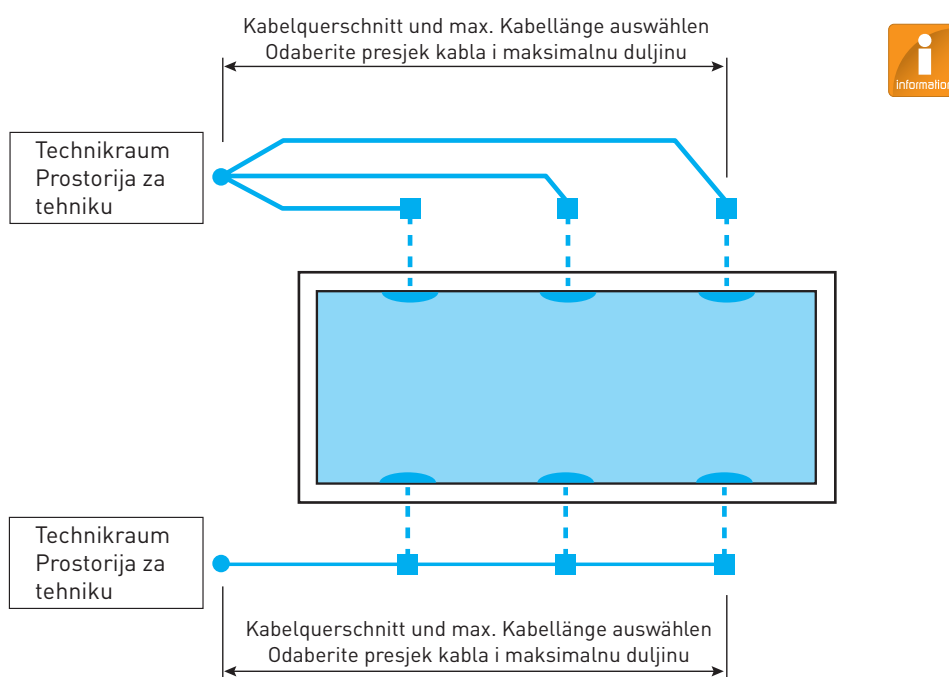

Trafostation für Adagio PRO – wenn alle Lampen mit einer Leitung/ einem Kabel an den Transformator angeschlossen sind.

Transformatori za Adagio PRO – ako su sve žarulje spojene na transformator s jednim vodičem/kablom.

Trafostation für Schwimmbadbeleuchtung Adagio PRO | Transformator za rasvjete za bazene Adagio PRO

Beleuchtungsart Broj žarulja	Leuchtenanzahl Broj žarulja	Draht-/Leiterquerschnitt/vodiče Poprečni presjek žice/vodiča				Art der Trafostation Model transformatora	KG	Price
		2,5 mm ²	4,0 mm ²	6,0 mm ²	10,0 mm ²			
85WH30PRO	B	1	35 m	57 m	85 m	142 m	100 W	
		2	17 m	28 m	42 m	71 m	200 W	
		3	11 m	19 m	28 m	47 m	200 W	
		4	8 m	14 m	21 m	35 m	300 W	
85RGB45PRO	B	1	20 m	33 m	50 m	80 m	100 W	
		2	10 m	16 m	25 m	40 m	100 W	
		3	-	11 m	16 m	26 m	200 W	
		4	-	8 m	12 m	20 m	200 W	
85WH60PRO	B	1	7 m	11 m	16 m	28 m	200 W	
		2	-	5 m	8 m	14 m	300 W	
		3	-	-	5 m	9 m	600 W	
		4	-	-	-	7 m	600 W	
85RGB75PRO	B	1	10 m	16 m	25 m	42 m	100 W	
		2	-	8 m	12 m	21 m	200 W	
		3	-	5 m	8 m	14 m	300 W	
		4	-	-	6 m	10 m	600 W	

Schwimmbadbeleuchtung MTS

Schwimmbadbeleuchtung MTS sind immer mit einstellbarem Scheinwerfer, Messinginsätzen und 3-m-Kabel ausgestattet.

MTS 300 W

- Lichtintensität 3 300 lm
- Leistung 300 W/12 V

MTS 300 W

- Intenzitet svjetlosti 3 300 lm
- Snaga 300 W/12 V

Lampe
Žarulja
300 W

**Schwimmbadbeleuchtung MTS 300 W | Rasvjete za bazene MTS 300 W**

	85535	8553	855358	8533
	weiß ABS / bijelo, ABS	ABS-Kunststoff / plastika ABS	grau ABS / sivo, ABS	Edelstahl / nehrđajući čelik
	3,10	3,10	3,10	3,50
Price				

MTS LED – weiß

- Leistung 13,5 W/12 V (SeaMAID 81501542)
- Lichtintensität 1 650 lm

MTS LED – bijelo

- Snaga 13,5 W/12 V (SeaMAID 81501542)
- Intenzitet svjetlosti 1 650 lm

LED
weiß
bijelo
13,5 W

**Schwimmbadbeleuchtung MTS LED – weiß | Rasvjete za bazene MTS LED – bijelo**

	85535LED16W	8553LED16W	855358LED16W	8533LED16W
	weiß ABS / bijelo, ABS	ABS-Kunststoff / plastika ABS	grau ABS / sivo, ABS	Edelstahl / nehrđajući čelik
	3,10	3,10	3,10	3,50
Price				

MTS LED – RGB

- Leistung LED 16 W/12 V (SeaMAID 81501535)
- Lichtintensität 510 lm

MTS LED – RGB

- Snaga 16 W/ 12 V (SeaMAID 81501535)
- Intenzitet svjetlosti 510 lm

LED
RGB
16 W

**Schwimmbadbeleuchtung MTS LED – RGB | Rasvjete za bazene MTS LED – RGB**

	85535LED16R	8553LED16R	855358LED16R	8533LED16R
	weiß ABS / bijelo, ABS	ABS-Kunststoff/plastika ABS	grau ABS / sivo, ABS	Edelstahl / nehrđajući čelik
	3,10	3,10	3,10	3,50
Price				

Sicherheitstransformatoren

Für Unterwasserlichter 50–300 W. Im Gehäuse aus speziellem, wärmebeständigem Kunststoff, 600 und 900 W im Stahlgehäuse mit einer hochwertigen Lackfläche.



Sigurnosni transformatori

Za rasvjetna tijela 50–300 W. Smješteni su u kućište od posebne plastike otporne na toplinu, 600 i 900 W nalaze se u čeličnom kućištu lakirane površine visoke kvalitete.

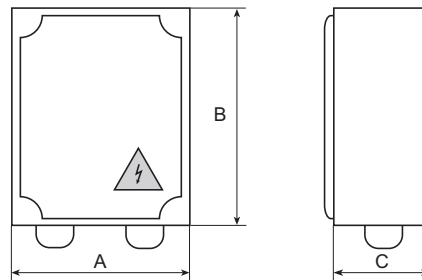

	A	B	C
50 W	140	175	115
100 W	140	175	115
200 W	140	175	155
300 W	140	175	155
600 W	200	220	175
900 W	200	220	175

Sicherheitstransformator Sigurnosni transformator				Price
890050	Sicherheitstransformator 230 V/12 V, 50 W, Schutzart IP65 Sigurnosni transformator 230 V/12 V, 50 W, zaštita IP65			1, 2,55
890100	Sicherheitstransformator 230 V/12 V, 100 W, Schutzart IP65 Sigurnosni transformator 230 V/12 V, 100 W, zaštita IP65			1, 2,82
890200	Sicherheitstransformator 230 V/12 V, 200 W, Schutzart P65 Sigurnosni transformator 230 V/12 V, 200 W, zaštita P65			1, 4,80
890300	Sicherheitstransformator 230 V/12 V, 300 W, Schutzart IP65 Sigurnosni transformator 230 V/12 V, 300 W, zaštita IP65			1, 5,63
890600	Sicherheitstransformator 230 V/12 V, 600 W(2 300 W, Schutzart IP65 Sigurnosni transformator 230 V/12 V, 600 W (2 x 300 W), zaštita IP65			1, 14,10
890900	Sicherheitstransformator 230 V/12 V, 900 W(3 x 300 W, Schutzart IP65 Sigurnosni transformator 230 V/12 V, 900 W (3 x 300 W), zaštita IP65			1, 15,20

Sicherheitstransformator, vollgegossen Sigurnosni transformator zaliveni				Price
8900501	Sicherheitstransformator 230 V/12 V, 50 W, Schutzart IP54 Sigurnosni transformator 230 V/12 V, 50 W, zaštita IP54			1, 1,8
8901001	Sicherheitstransformator 230 V/12 V, 100 W, Schutzart IP54 Sigurnosni transformator 230 V/12 V, 100 W, zaštita IP54			1, 2,2
8902001	Sicherheitstransformator 230 V/12 V, 200 W, Schutzart IP54 Sigurnosni transformator 230 V/12 V, 200 W, zaštita IP54			1, 3,5
8903001	Sicherheitstransformator 230 V/12 V, 300 W, Schutzart IP54 Sigurnosni transformator 230 V/12 V, 300 W, zaštita IP54			1, 5,5

Sicherheitstransformator Sigurnosni transformator				Price
890040	Sicherheitstransformator für LED 230 V/12 V, 40 W, Schutzart IP65 Sigurnosni transformator za LED 230 V/12 V, 40 W, zaštita IP65			1, 2,0
890080	Sicherheitstransformator für LED 230 V/12 V, 80 W, Schutzart IP65 Sigurnosni transformator za LED 230 V/12 V, 80 W, zaštita IP65			1, 2,5
890170	Sicherheitstransformator für LED 230 V/12 V, 170 W, Schutzart IP65 Sigurnosni transformator za LED 230 V/12 V, 170 W, zaštita IP65			1, 3,0

Sicherheitstransformator, vollgegossen Sigurnosni transformator zaliveni				Price
8900401	Sicherheitstransformator für LED 230 V/12 V, 40 W, Schutzart IP54 Sigurnosni transformator za LED 230 V/12 V, 40 W, zaštita IP54			1, 2,0
8900801	Sicherheitstransformator für LED 230 V/12 V, 80 W, Schutzart IP54 Sigurnosni transformator za LED 230 V/12 V, 80 W, zaštita IP54			1, 2,5
8901701	Sicherheitstransformator für LED 230 V/12 V, 170 W, Schutzart IP54 Sigurnosni transformator za LED 230 V/12 V, 170 W, zaštita IP54			1, 3,0

Sicherheitstransformator, Ringkern Sigurnosni transformator toroidni				Price
8901002	Sicherheitstransformator, Ringkern, 230 V/12 V, 100 W, Schutzart IP65 Sigurnosni transformator toroidni 230 V/12 V, 100 W, zaštita IP65			1, 2,0
8902002	Sicherheitstransformator, Ringkern, 230 V/12 V, 200 W, Schutzart IP65 Sigurnosni transformator toroidni 230 V/12 V, 200 W, zaštita IP65			1, 2,5
8903002	Sicherheitstransformator, Ringkern, 230 V/12 V, 300 W, Schutzart IP65 Sigurnosni transformator toroidni 230 V/12 V, 300 W, zaštita IP65			1, 3,2

Zubehör Schwimmbadbeleuchtung



873495V

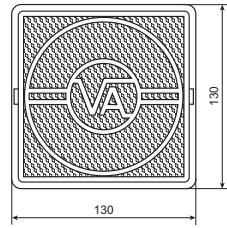

06109240081

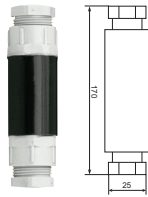

8705, 8707

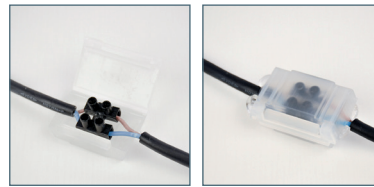

81500338



8701



8706

Oprema za rasvjetu bazena



HPR20018

Zubehör | Oprema

Zubehör Oprema				Price			
873495V	Abzweigdose für Kabel VA Razvodna kutija za kabel VA				1	0,34	
8705	Verlängerungskabel PG 16 Produžetak za kabel PG 16				1	0,10	
8701	Abzweigdose für Kabel MTS, PG 29/21/13,5 Razvodna kutija za kabel MTS, PG 29/21/13,5				60	0,30	
8707	Kabelverlängerung PG11 – für LED Produžni kabel PG11 – za LED				1	0,10	
HPR20018	Verbindungsschlauch zum Kabelanschluss Spojno crijevo za spajanje kabla				1	0,15	
06109240081	Silikonkabel 2 x 4 mm ² Silikonski kabel 2 x 4 mm ²					0,40	
8706	Abdichtungsmasse für Abzweigdose für Kabel Hidroizolacijska masa za brtvljenje kabelske razvodne kutije				18	0,60	
81500338	GEL BOX für Kabel 3 x 6 mm ² (IP68) GEL BOX za kabel 3 x 6 mm ² (IP68)				1	0,06	

Schwimmbadbeleuchtung SeaMAID mit Magnet

- Magnethintergrund
- Der Einbau unter dem Wasserspiegel ist nicht notwendig
- Es kann im Garten oder im Maschinenraum platziert werden
- 18 LED
- Batterie: 3 200 mAh

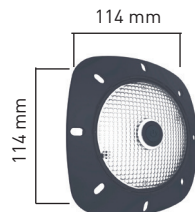

Rasvjete za bazene SeaMAID s magnetom

- Magnetska pozadina
- Nije potrebna ugradnja ispod razine vode
- Može se postaviti u vrt, u strojarnici
- 18 LED
- Baterija: 3 200 mAh

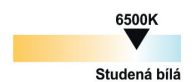
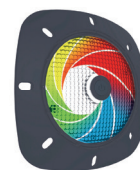

2 W = 20 W

Magnetlicht | Svjetlo s magnetom

Magnetlicht Svjetlo s magnetom				Price		
85502013	Schwimmbadbeleuchtung mit Magnet SeaMAID – graue Fassung, 18 LED weiß, 2 W, 200 lm Rasvjete za bazene s magnetom SeaMAID – sivi okvir, 18 LED bijelo, 2 W, 200 lm			1	0,30	
85502112	Schwimmbadbeleuchtung mit Magnet SeaMAID – graue Fassung, 18 LED RGB, 4 W, 100 lm Rasvjete za bazene s magnetom SeaMAID – sivi okvir, 18 LED RGB, 4 W, 100 lm			1	0,30	

Schwimmbadbeleuchtung Hugo Lahme

- Bei allen Schwimmbadbeleuchtung Hugo Lahme müssen stets die Trafos von Hugo Lahme verwendet werden
- Weißes Licht – 6 000 K
- RGBW ist eine neue Art von Licht, das sowohl eine weiße Farbe sowie das gesamte Farbspektrum ausstrahlen kann

Rasvjete za bazene Hugo Lahme

- Za sva rasvjeta za bazene Hugo Lahme uvijek treba koristiti napajanje Hugo Lahme
- Bijelo svjetlo – 6 000 K
- RGBW nova je vrsta rasvjete koja može emitirati oboje, čistu bijelu i cijeli spektar boja



HL4.4000



HL4.402.. / HL4.403..



HL4.404..



Schwimmbadbeleuchtung Hugo Lahme Rasvjete za bazene Hugo Lahme				Price
HL4.4000020	Kräftiges LED Leuchtmittel, 28 LED – 14 900 lm, 24 V, Farbe weiß 6 000 K, Ø 270 mm Snažno LED svjetlo, 28 LED – 14 900 lm, 24 V, boja bijela 6 000 K, Ø 270 mm		1	
HL4.4000220	Kräftiges LED Leuchtmittel, 28 LED – 11 100 lm, 24 V, RGBW - farbig + weiß 6 000 K, Ø 270 mm Snažno LED svjetlo, 28 LED – 11 100 lm, 24 V, RGBW – u boji + bijelo, Ø 270 mm		1	
HL4.4020020	Kräftiges LED Leuchtmittel, 16 LED – 7 900 lm, 24 V, Farbe weiß 6 000 K, Ø 146 mm Snažno LED svjetlo, 16 LED – 7 900 lm, 24 V, boja bijela 6 000 K, Ø 146 mm		1	
HL4.4020220	Kräftiges LED Leuchtmittel, 16 LED – 5 500 lm, 24 V, RGBW - farbig + weiß 6 000 K, Ø 146 mm Snažno LED svjetlo, 16 LED – 5 500 lm, 24 V, RGBW – u boji + bijelo, Ø 146 mm		1	
HL4.4030020	Kräftiges LED Leuchtmittel, 8 LED – 4 300 lm, 24 V, Farbe weiß 6 000 K, Ø 146 mm Snažno LED svjetlo, 8 LED – 4 300 lm, 24 V, boja bijela 6 000 K, Ø 146 mm		1	
HL4.4030220	Kräftiges LED Leuchtmittel, 8 LED – 3 000 lm, 24 V, RGBW - farbig + weiß 6 000 K, Ø 146 mm Snažno LED svjetlo, 8 LED, 3 000 lm, 24 V, RGBW – u boji + bijelo, Ø 146 mm		1	
HL4.4040020	Kräftiges LED Leuchtmittel, 4 LED – 1 890 lm, 24 V, Farbe weiß 6 000 K, Ø 110 mm Snažno LED svjetlo, 4 LED – 1 890 lm, 24 V, boja bijela 6 000 K, Ø 110 mm		1	
HL4.4040220	Kräftiges LED Leuchtmittel, 4 LED – 1 220 lm, 24 V, RGBW - farbig + weiß 6 000 K, Ø 110 mm Snažno LED svjetlo, 4 LED – 1 220 lm, 24 V, RGBW – u boji + bijelo, Ø 110 mm		1	



HL4100050

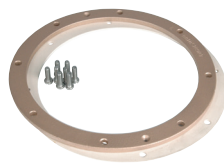

















HL4060050



HL4400320

Zubehör- einzubauende Elemente Oprema – elementi za ugradnju				Price
HL4100050	Anschlussdose für Unterwasserlichter mit Kabelschutz, für Keramik- und Folienpools Priključna kutija za rasvjetna tijela sa zaštitom kabla, za keramičke i folijske bazene		1	6,0
HL4060050	Flanschsatz für Folienpools, für die Anschlussdose 4100050 Komplet prilubnica za folijske bazene za priključnu kutiju 4100050		1	0,5
HL4400320	Lichtnische – zum Schweißen mit Kabelschutz Kućište za rasvjetno tijelo- za varenje, sa zaštitom za kabel		1	6,0

Zubehör Oprema				Price
HL40600050	Hauptstromquelle für 2-weiße-LED-Leuchten (24 VDC, LED 3,0) oder zusätzliche Stromquelle für weitere 2 RGB-Leuchten Glavni izvor za 2 bijela LED svjetla (24 VDC, LED 3,0) ili dodatni izvor za još 2 RGB svjetla		1	4,0
HL40600150	Hauptstromquelle für 2 RGB LED-Leuchten (24 VDC, LED 3,0) – Steuereinheit Glavni izvor za 2 RGB LED svjetla (24 VDC, LED 3,0) – upravljačka jedinica		1	10,0
HL40000050	Fernbedienung IP 65 mit Empfänger Daljinski upravljač IP 65 s prijammikom		1	0,4
HL576841	DMX-Modul (Leiterplatte) für die Hauptquelle 4380150 – für Computersteuerung DMX modul (tiskana pločica) za glavni izvor 4380150 – za upravljanje preko računala		1	0,2
HL4010020	Abzweigdose mit quadratischem Deckel Razvodna kutija s četvrtastim poklopcem		1	1,0

Glühlampe Žarulja				Price
801303	Glühlampe 300 W/12 V Žarulja 300 W/12 V		 12	0,60
Halogenlampe Halogena žarulja				 Price
808417	Halogenlampe HRFG 50 W/12 V – mit Frontglas, 50 mm Halogena žarulja HRFG 50 W/12 V – s prednjim staklom, 50 mm		 1	0,04
Halogenlampe Halogena žarulja				 Price
841407	Halogenlampe H2 50 W/12 V Halogena žarulja H2 50 W/12 V		 1	0,01
841607	Halogenlampe H2 100 W/12 V Halogena žarulja H2 100 W/12 V		 1	0,01



Beitrag zum Wettbewerb „Schwimmbad des Jahres 2022“ – Firma INOX SERVIS
Doprinos natjecanju „Bazen godine 2022“ – tvrtka INOX SERVIS