

Bazénové žebříky	112	Pool ladders	112
Madla	116	Handrails	116
Bazénové žebříky, příslušenství	118	Pool ladders, accessories	118

6



Žebříky

jsou určeny pro privátní a komerční bazény. Jsou vyrobeny z leštěné nerez oceli AISI 304 (AISI 316) o průměru 43 mm. Stupně jsou doplněny protiskluz. nášlapy. Každý žebřík je zakončen opěrným kloubem směrem ke stěně bazénu. Kotvení se dodává s pouzdem a svorkou pro uzemnění.



7012-5

Ladders

are designed for use in both private and public swimming pools. Ladders are made of glossy stainless steel AISI 304 (AISI 316) with diameter of 43 mm. Steps have anti slip parts from plastic. Every ladder is finished with a supporting joint to the pool wall. Ladders can be mounted on the pool edge via anchor socket or flange.

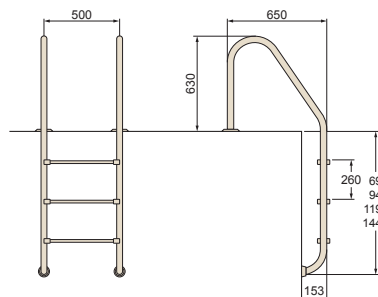

Technická data

- Protiskluzové nášlapy
- Kotvicí pouzdra
- + možno doplnit
- Dvojitý první stupeň
- Kotvicí příruby
- Opěrné klouby

Technical data

- Anti-slip steps
- Anchor sockets
- + available as spares
- Double first step
- Anchor flanges
- Supporting joints

Žebřík nerez Standard Ladder stainless steel Standard						KG	cena Kč	cena Kč	€
AISI 304 STAINLESS STEEL NEREZ	AISI 316 STAINLESS STEEL NEREZ						AISI 304 STAINLESS STEEL NEREZ	AISI 316 STAINLESS STEEL NEREZ	
7012	7312	B	Žebřík nerez Standard s pouzdem 2 stupňový Ladder – stainless steel – Standard – with anchor socket 2 stairs			10,0	5 851,-	8 179,-	
7013	7313	B	Žebřík nerez Standard s pouzdem 3 stupňový Ladder – stainless steel – Standard – with anchor socket 3 stairs			11,5	6 301,-	8 774,-	
7014	7314	B	Žebřík nerez Standard s pouzdem 4 stupňový Ladder – stainless steel – Standard – with anchor socket 4 stairs			13,5	7 418,-	10 055,-	
7015	7315	B	Žebřík nerez Standard s pouzdem 5 stupňový Ladder – stainless steel – Standard – with anchor socket 5 stairs			15,0	8 258,-	11 473,-	



7052-5

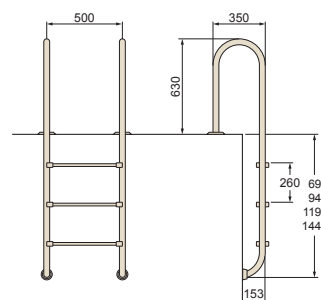

Technická data

- Protiskluzové nášlapy
- Kotvicí pouzdra
- + možno doplnit
- Dvojitý první stupeň
- Kotvicí příruby
- Opěrné klouby

Technical data

- Anti-slip steps
- Anchor sockets
- + available as spares
- Double first step
- Anchor flanges
- Supporting joints

Žebřík nerez Muro Ladder stainless steel Muro						KG	cena Kč	cena Kč	€
AISI 304 STAINLESS STEEL NEREZ	AISI 316 STAINLESS STEEL NEREZ						AISI 304 STAINLESS STEEL NEREZ	AISI 316 STAINLESS STEEL NEREZ	
7052	7352	B	Žebřík nerez Muro (Slim) s pouzdem 2 stupňový Ladder – stainless steel – Muro (Slim) – with anchor socket 2 stairs			9,50	6 158,-	8 297,-	
7053	7353	B	Žebřík nerez Muro (Slim) s pouzdem 3 stupňový Ladder – stainless steel – Muro (Slim) – with anchor socket 3 stairs			10,5	6 721,-	9 313,-	
7054	7354	B	Žebřík nerez Muro (Slim) s pouzdem 4 stupňový Ladder – stainless steel – Muro (Slim) – with anchor socket 4 stairs			12,5	7 908,-	10 460,-	
7055	7355	B	Žebřík nerez Muro (Slim) s pouzdem 5 stupňový Ladder – stainless steel – Muro (Slim) – with anchor socket 5 stairs			14,0	8 748,-	11 743,-	



7032-5

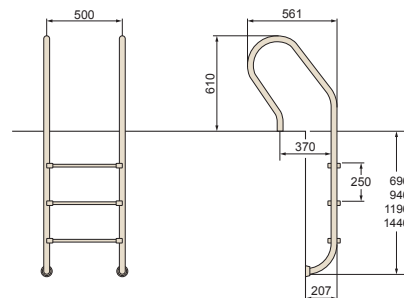
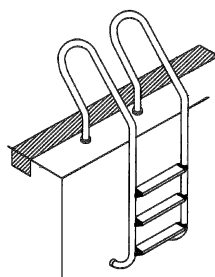

Technická data

- Protiskluzové nášlapy
- Kotvicí pouzdra
- + možno doplnit
- Dvojitý první stupeň
- Kotvicí příruby
- Opěrné klouby

Technical data

- Anti-slip steps
- Anchor sockets
- + available as spares
- Double first step
- Anchor flanges
- Supporting joints

Žebřík nerez Mixta Ladder stainless steel Mixta				KG	cena Kč	cena Kč	€
AISI 304 STAINLESS STEEL NEREZ	AISI 316 STAINLESS STEEL NEREZ				AISI 304 STAINLESS STEEL NEREZ	AISI 316 STAINLESS STEEL NEREZ	
7032	-	B	Žebřík nerez Mixta s pouzdrům 2 stupňový Ladder stainless steel Mixta with anchor socket 2 stairs		10,5	6 299,-	-
7033	7333	B	Žebřík nerez Mixta s pouzdrům 3 stupňový Ladder stainless steel Mixta with anchor socket 3 stairs		11,0	7 069,-	9 313,-
7034	7334	B	Žebřík nerez Mixta s pouzdrům 4 stupňový Ladder stainless steel Mixta with anchor socket 4 stairs		14,0	8 118,-	10 460,-
7035	7335	B	Žebřík nerez Mixta s pouzdrům 5 stupňový Ladder stainless steel Mixta with anchor socket 5 stairs		15,5	8 801,-	11 743,-

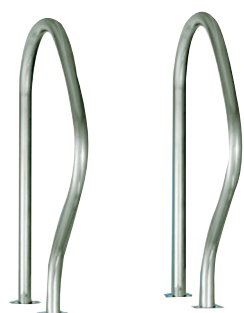

2x 7310 – strana 118



Spodní díl 739...

Dvoudílné bazénové žebříky jsou svojí konstrukcí určeny pro bazény, které jsou vybaveny rolovacím systémem pro krycí plachtu nebo krycí roletou apod.

Two parts pool ladders are constructed for swimming pools equipped with covering rolling system.

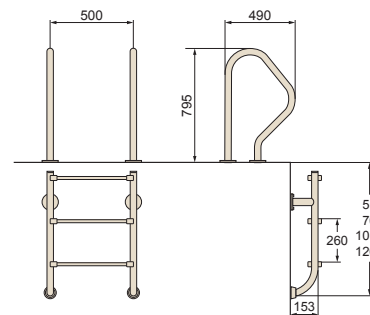

Technická data

- Protiskluzové nášlapy
- Kotvicí pouzdra
- + možno doplnit
- Dvojitý první stupeň
- Kotvicí příruby
- Opěrné klouby

Technical data

- Anti-slip steps
- Anchor sockets
- + available as spares
- Double first step
- Anchor flanges
- Supporting joints

Žebřík nerez dvoudílný Ladder stainless steel two-piece				KG	cena Kč	cena Kč	€
AISI 316 STAINLESS STEEL NEREZ					AISI 316 STAINLESS STEEL NEREZ		
7310	B	B	Žebříkové madlo s přírubou – 1 ks Ladder handrail with flange – 1 pc		3,75	3 931,-	
73921	B	B	Spodní díl nerezového žebříku – 2 stupně (kotvení přírubou), AISI 316 Bottom part of stainless steel ladder – 2 stairs (flange), AISI 316		9,50	12 171,-	
73931	B	B	Spodní díl nerezového žebříku – 3 stupně (kotvení přírubou), AISI 316 Bottom part of stainless steel ladder – 3 stairs (flange), AISI 316		11,0	14 042,-	
73941	B	B	Spodní díl nerezového žebříku – 4 stupně (kotvení přírubou), AISI 316 Bottom part of stainless steel ladder – 4 stairs (flange), AISI 316		12,5	15 747,-	
73951	B	B	Spodní díl nerezového žebříku – 5 stupňů (kotvení přírubou), AISI 316 Bottom part of stainless steel ladder – 5 stairs (flange), AISI 316		14,0	17 565,-	

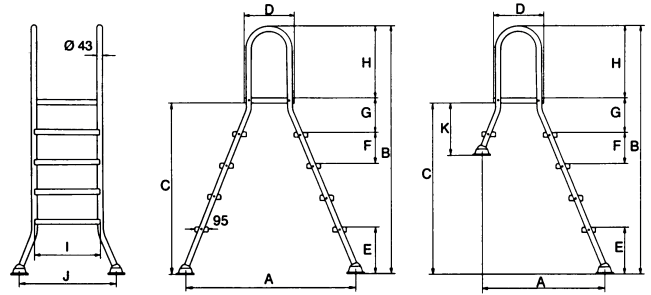

model	treads	platform	A	B	C	D	E	F	G	H	I	J	K
EEP-3	3 + 3	1	1 090	1 610	1 050	360	390	230	260	500	500	710	-
EEP-4	4 + 4	1	1 250	1 840	1 280	360	390	230	260	500	500	710	-
EEP-5	5 + 5	1	1 410	2 070	1 510	360	390	230	260	500	500	710	-
ESP-3	3 + 1	1	0890	1 610	1 050	360	390	230	260	500	500	710	480
ESP-4	4 + 1	1	0970	1 840	1 280	360	390	230	260	500	500	710	480
ESP-5	5 + 1	1	1 050	2 070	1 510	360	390	230	260	500	500	710	480

Žebřík nerez EEP | Ladder stainless steel EEP

				KG	cena Kč	cena Kč	€
AISI 304 STAINLESS STEEL NERAZ							
7083	B	Žebřík EEP pro nezapuštěné bazény – 3 + 3 stupně, pro bazény 1 m Stairs EEP for overground pools – 3 + 3 stairs, for pools higher than 1 m		20,0	10 887,-		
7084	B	Žebřík EEP pro nezapuštěné bazény – 4 + 4 stupně, pro bazény 1,2 m Stairs EEP for overground pools – 4 + 4 stairs, for pools higher than 1,2 m		21,5	13 384,-		
7085	B	Žebřík EEP pro nezapuštěné bazény – 5 + 5 stupňů, pro bazény 1,5 m Stairs EEP for overground pools – 5 + 5 stairs, for pools higher than 1,5 m		24,8	15 879,-		

Žebřík nerez ESP | Ladder stainless steel ESP

				KG	cena Kč	cena Kč	€
AISI 304 STAINLESS STEEL NERAZ							
7073	B	Žebřík ESP pro nezapuštěné bazény – 3 + 1 stupeň, pro bazény 1 m Stairs ESP for overground pools – 3 + 1 stairs, for pools higher than 1 m		17,5	10 072,-		
7074	B	Žebřík ESP pro nezapuštěné bazény – 4 + 1 stupeň, pro bazény 1,2 m Stairs ESP for overground pools – 4 + 1 stairs, for pools higher than 1,2 m		18,7	10 893,-		
7075	B	Žebřík ESP pro nezapuštěné bazény – 5 + 1 stupeň, pro bazény 1,5 m Stairs ESP for overground pools – 5 + 1 stairs, for pools higher than 1,5 m		19,8	11 567,-		



73221-5

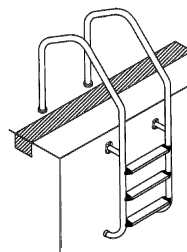

Technická data

- Protiskuzové nášlapy
- Kotvicí pouzdra
- + možno doplnit
- Dvojitý prvni stupeň
- Kotvicí příruby
- Opěrné klouby

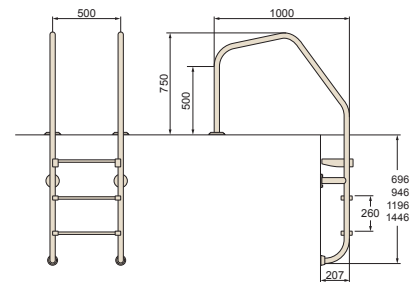

Technical data

- Anti-slip steps
- Anchor sockets
- + available as spares
- Double first step
- Anchor flanges
- Supporting joints

Žebřík nerez Munich | Ladder stainless steel Munich

				KG	cena Kč	cena Kč	€
AISI 316 STAINLESS STEEL NERAZ							
73221	B	Žebřík nerez série MUNICH s pouzdrům 2 stupňový pro komerční bazény s přelivem Ladder – st. steel – serie MUNICH with anchor socket 2 stairs for public pools with overflow		11,0	14 435,-		
73231	B	Žebřík nerez série MUNICH s pouzdrům 3 stupňový pro komerční bazény s přelivem Ladder – st. steel – serie MUNICH with anchor socket 3 stairs for public pools with overflow		13,0	16 681,-		
73241	B	Žebřík nerez série MUNICH s pouzdrům 4 stupňový pro komerční bazény s přelivem Ladder – st. steel – serie MUNICH with anchor socket 4 stairs for public pools with overflow		15,0	17 953,-		
73251	B	Žebřík nerez série MUNICH s pouzdrům 5 stupňový pro komerční bazény s přelivem Ladder – st. steel – serie MUNICH with anchor socket 5 stairs for public pools with overflow		15,0	18 880,-		



Technická data

- Protiskluzové nášlapy
- Kotvicí pouzdra
- + možno doplnit
- Kotvicí příruby
- Opěrné klouby

Technical data

- Anti-slip steps
- Anchor sockets
- + available as spares
- Anchor flanges
- Supporting joints

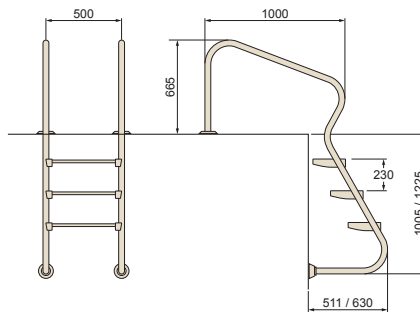

Žebřík nerez Ergo Ladder st. steel Ergo				KG	cena Kč	cena Kč	€
	AISI 316 STAINLESS STEEL NEREZ					AISI 316 STAINLESS STEEL NEREZ	
73113	B	Žebřík nerez Ergo s pouzdem 3 stupňový Ladder stainless steel Ergo with anchor socket 3 stairs		16,0		23 613,-	
73114	B	Žebřík nerez Ergo s pouzdem 4 stupňový Ladder stainless steel Ergo with anchor socket 4 stairs		18,0		28 580,-	

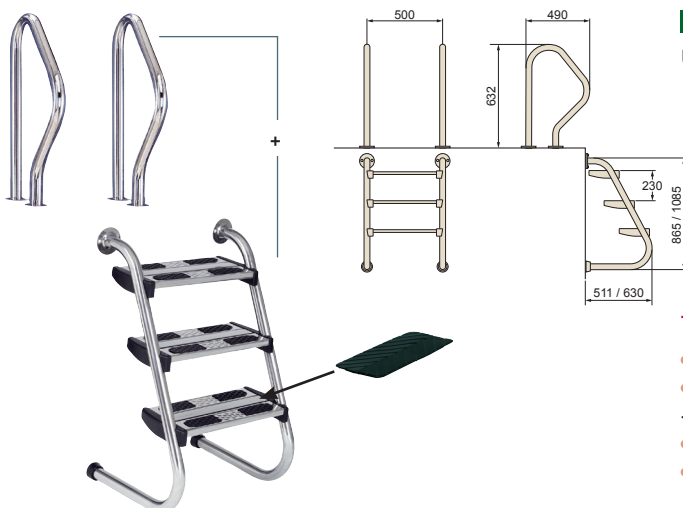

Žebřík nerez Ergo

Určeno pro bazény se zakrytím

Ladder stainless steel Ergo

Pool ladders constructed for swimming pools equipped with covering rolling system.

Technická data

- Protiskluzové nášlapy
- Kotvicí pouzdra
- + možno doplnit
- Kotvicí příruby
- Opěrné klouby

Technical data

- Anti-slip steps
- Anchor sockets
- + available as spares
- Anchor flanges
- Supporting joints

Žebřík nerez dvoudílný Ergo Ladder st. steel two-piece Ergo				KG	cena Kč	cena Kč	€
	AISI 316 STAINLESS STEEL NEREZ					AISI 316 STAINLESS STEEL NEREZ	
7310	B	Žebříkové madlo s přírubou – 1 ks Ladder handrail with flange – 1 pcs		3,75		3 931,-	
73913	B	Spodní díl nerezového žebříku ERGO – 3 stupně (kotvení přírubou) Bottom part of stainless steel ladder ERGO – 3 stairs, (flange)		18,0		22 464,-	
73914	B	Spodní díl nerezového žebříku ERGO – 4 stupně (kotvení přírubou) Bottom part of stainless steel ladder ERGO – 4 stairs, (flange)		18,0		29 940,-	

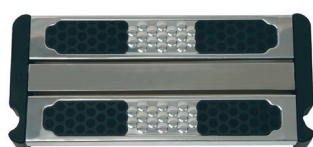

F87101606

Dvojitý stupeň lze namontovat na jakýkoli bazénový žebřík s kolmým madlem.

Double step can be used on any swimming pool ladder with vertical handrail.

Dvojitý stupeň Double step				KG	cena Kč	€
F87101606	B	Rozšířený (dvojitý) stupeň pro žebřík – NEREZ AISI 316 Double step for stairs – STAINLESS STEEL AISI 316		0,30		4 029,-



70BP1200, 70BP1500



75BP1201, 75BP1501

AISI 316
STAINLESS STEEL
N E R Ž

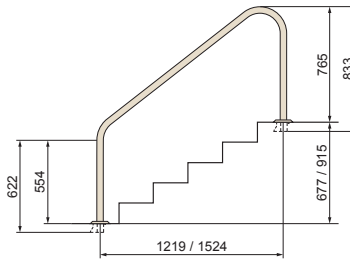

70BP1200, 70BP1500

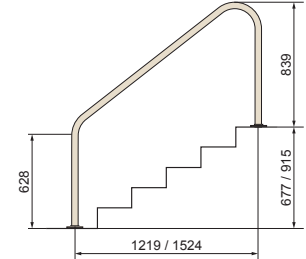

75BP1201, 75BP1501

Zábradlí | Handrail

			KG	cena Kč	€
70BP1200	B	Zábradlí ke schodům Handrail for staircase	8,20	6 418,-	
70BP1500	B	Zábradlí ke schodům Handrail for staircase	9,10	6 903,-	
75BP1201	B	Zábradlí s pevnou přírubou Handrail with flange	8,20	7 064,-	
75BP1501	B	Zábradlí s pevnou přírubou Handrail with flange	9,10	7 416,-	



7310

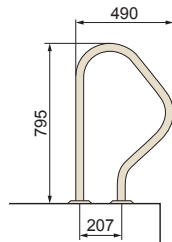

73011

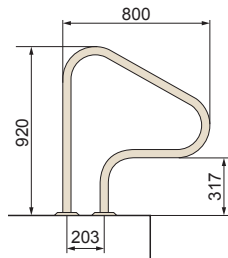

73013

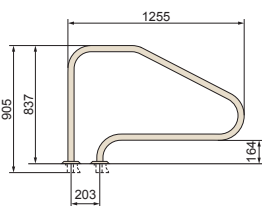

73014

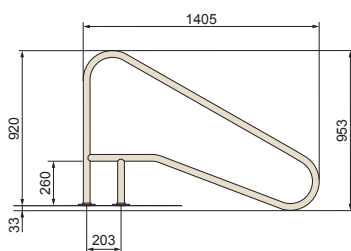

73012

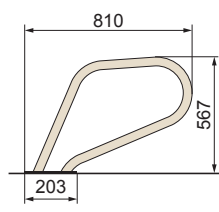

Žebříkové madlo | Ladder handrail

			KG	cena Kč	€
7310	B	Žebříkové madlo s přírubou - 1 ks Ladder handrail with flange - 1 pc	3,75	3 931,-	



Žebříkové madlo | Ladder handrail

			KG	cena Kč	€
73011	B	Žebříkové madlo s pouzdem - 1 ks Ladder handrail with anchor - 1 pc	3,20	4 550,-	



Žebříkové madlo | Ladder handrail

			KG	cena Kč	€
73013	B	Žebříkové madlo s pouzdem - 1 ks Ladder handrail with anchor - 1 pc	4,60	6 131,-	



Žebříkové madlo | Ladder handrail

			KG	cena Kč	€
73014	B	Žebříkové madlo s pouzdem - 1 ks Ladder handrail with anchor - 1 pc	5,40	8 008,-	



Žebříkové madlo | Ladder handrail

			KG	cena Kč	€
73012	B	Žebříkové madlo s přírubou - 1 ks Ladder handrail with flange - 1 pc	7,50	5 633,-	



713005-20

AISI 316
STAINLESS STEEL
N E R E Z

Madlo Handrail			KG	cena Kč	€
713005	B	Madlo 0,4 m (AISI 316) Handrail 0,4 m (AISI 316)	0,60	5 312,-	
713010	B	Madlo 1 m (AISI 316) Handrail 1 m (AISI 316)	1,20	7 544,-	
713015	B	Madlo 1,5 m (AISI 316) Handrail 1,5 m (AISI 316)	1,80	9 276,-	
713020	B	Madlo 2 m (AISI 316) Handrail 2 m (AISI 316)	2,40	12 471,-	



AISI 316
STAINLESS STEEL
N E R E Z

Madlo Handrail			KG	cena Kč	€
713105	B	Madlo 0,5 m (AISI 316) Handrail 0,5 m (AISI 316)	0,60	3 277,-	
713110	B	Madlo 1 m (AISI 316) Handrail 1 m (AISI 316)	1,20	3 749,-	
713115	B	Madlo 1,5 m (AISI 316) Handrail 1,5 m (AISI 316)	1,80	4 601,-	
713120	B	Madlo 2 m (AISI 316) Handrail 2 m (AISI 316)	2,40	5 246,-	
713130	B	Madlo 3 m (AISI 316) Handrail 3 m (AISI 316)	3,60	7 192,-	













AISI 304
STAINLESS STEEL
N E R E Z

VAGNER
POOL

Příslušenství Accessories			KG	cena Kč	€
713505	B	Nerez trubka pro zábradlí - Ø 35 mm, délka 0,5 m Stainless steel tube for staircase - Ø 35 mm, length 0,5 m	0,40	619,-	
713510	B	Nerez trubka pro zábradlí - Ø 35 mm, délka 1 m Stainless steel tube for staircase - Ø 35 mm, length 1 m	0,80	777,-	
713515	B	Nerez trubka pro zábradlí - Ø 35 mm, délka 1,5 m Stainless steel tube for staircase - Ø 35 mm, length 1,5 m	1,20	1 014,-	
713520	B	Nerez trubka pro zábradlí - Ø 35 mm, délka 2 m Stainless steel tube for staircase - Ø 35 mm, length 2 m	1,60	1 248,-	
713501	B	Nerez přírubové úchyty zábradlí - průběžný Stainless steel flange fittings for staircase - connecting piece	0,30	857,-	
713502P	B	Nerez přírubové úchyty zábradlí - koncový zaslepený pravý Stainless steel flange fittings for staircase - end blinder right	0,35	1 112,-	
713502L	B	Nerez přírubové úchyty zábradlí - koncový zaslepený levý Stainless steel flange fittings for staircase - end blinder left	0,35	1 112,-	
713504	B	Kotvení do betonu, nerez - pro úchyt zábradlí Anchoring for betton, stainless steel - for staircase fitting	0,15	718,-	
713000	B	Sada šroubů pro uchycení Set of screws for fixing		42,-	



Příslušenství Accessories			KG	cena Kč	€
70100	B	Kotvení – plastové pouzdro – 1 ks Anchor plastic socket – 1 pc	 0,30	278,-/ks	
75100	B	Kotvení – nerez příruba – 1 ks Anchor stainless steel flange – 1 pc	 1,10	967,-/ks	
751003	B	Úchyt do betonu pro kotvení žebříku, nerez – 1 ks Fitting to concrete for anchoring ladders, stainless steel, 1 pc	 0,10	1 217,-/ks	
70101	B	Sklápěcí kloub do pouzdra pro žebříky – 1 ks Tip-up joint in to socket for ladders, 1 pc	 0,50	5 642,-/ks	
70102	B	Sklápěcí kloub s přírubou pro žebříky – 1 ks Tip-up joint with flange for ladders – 1 pc	 1,50	2 200,-/ks	
KRES050A	B	Krytka kotvení (rozeta), nerez – 1 ks Cover of anchor, stainless steel – 1 pc	 0,20	524,-/ks	
KRES031A	B	Opěrný kloub k žebříku – 1 ks Rubber joint – 1 pc	 0,30	269,-/ks	
7135022	B	Sada pro fólii – 1 ks Kit for liner – 1 pc	 0,40	1 569,-/ks	
512120	B	Pospojení Titan – uzemnění Earth connection Titan	 0,30	804,-	
F87170020	B	Anoda pro žebřík Anode for ladders	 0,20	383,-	
F87170034	B	Anoda pro madla Anode for handrails	 0,20	771,-	



Príspevek do súťaže „Bazén roku 2022“ – firma František Mašek
Participant of the „Pool of the Year 2022“ competition – company František Mašek