

# TRYSKY VAMILA VAMILA NOZZLE

# VAGNER POOL

SWIMMING POOL TECHNOLOGY



## VAMILA

**AISI 316**  
STAINLESS STEEL  
NEREZ

## Program VAMILA NEREZ Program VAMILA STAINLESS STEEL

### Základní prvek VAMILA

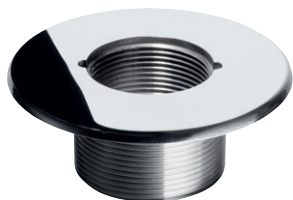

### Basic element VAMILA

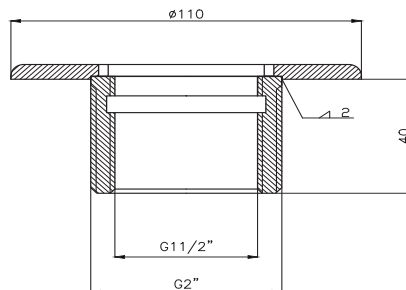

**AISI 316**  
STAINLESS STEEL  
NEREZ

### Sání pro atrakce VAMILA | Suction for attraction VAMILA

3070 Základní prvek VAMILA

Basic element VAMILA

### Nerezový rámeček trysky VAMILA



30705



Použití rámečku s tryskou VAMILA  
Example of using the VAMILA frame

### Stainless steel nozzle frame VAMILA

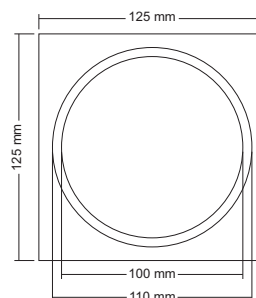

### Nerezový rámeček trysky VAMILA | Stainless steel nozzle frame VAMILA

30705 Nerezový rámeček trysky VAMILA - hranatý

Stainless steel nozzle frame VAMILA - square

**VAGNER**  
POOL

**VAMILA**

Montážní klíč  
Assembly spanner



30702



3072783



3077683



307253



30765



3070



3072781



3077681

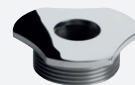

307251



307042



307278



307768

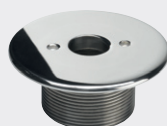

30725



307510

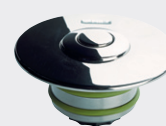

30760



30761

Trysky VAMILA mají vnější závit 2", který pasuje do většiny průchodů betonem pro trysky.  
The VAMILA nozzles have a 2" EX thread, which is compatible with most of the poolwall lead-throughs.

**AISI 316**  
STAINLESS STEEL  
NEREZ



3575

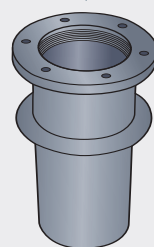

Průchod betonem  
Poolwall lead-through



31191



31190

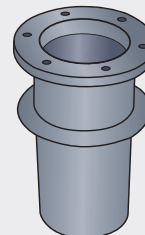

Průchod betonem  
Poolwall lead-through

Elektronické spínání  
PROPIEZO  
Electronic switch  
PROPIEZO

**Tryska VAMILA nerez | Nozzle stainless steel VAMILA**

307278	Vtoková tryska VAMILA nerez 2 x 7,8 mm AG R 2" x R 1/2" IG závit 40 mm	Inlet nozzle VAMILA stainless steel 2 x 7,8 mm AG R 2" x R 1/2" IG thread 40 mm
307768	Vtoková tryska VAMILA nerez 7 x 6,8 mm AG R 2" x R 1/2" IG závit 40 mm	Inlet nozzle VAMILA stainless steel 7 x 6,8 mm AG R 2" x R 1/2" IG thread 40 mm
30725	Vtoková tryska VAMILA nerez Ø 25 mm AG R 2" x R 1 1/2" IG závit 40 mm	Inlet nozzle VAMILA stainless steel Ø 25 mm AG R 2" x R 1 1/2" IG thread 40 mm
307510	Vtoková tryska VAMILA nerez 5 x Ø 10 mm AG R 2" x R 1 1/2" IG závit 40 mm	Inlet nozzle VAMILA stainless steel 5 x Ø 10 mm AG R 2" x R 1 1/2" IG thread 40 mm
30760	Pneumatické tlačítko VAMILA	Pneumatic button VAMILA
30761	Piezoelektrické tlačítko VAMILA	Piezoelectric button VAMILA
3575	Přírubová sada VAMILA k sání pro fólii (s použitím průchodu stěnou)	Flange set VAMILA for suction for liner (using pool wall lead-through)
31190	Průchod stěnou bazény nerez R 2", délka 300 mm	Poolwall lead-through stainless steel R 2", length 300 mm
31191	Průchod stěnou bazény pro fólii nerez R 2", délka 300 mm	Poolwall lead-through for liner stainless steel R 2", length 300 mm

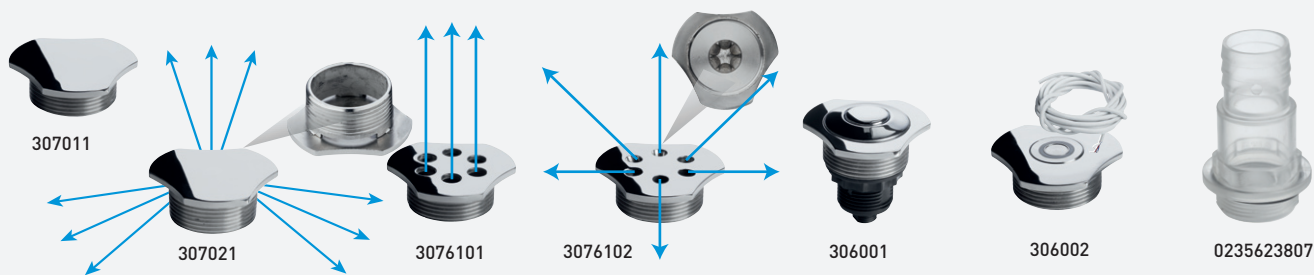

Vtokové části mají vnější závit 1½", který pasuje na základní prvky i u některých dalších výrobců trysek.

Inlet part of have thread 1½" EX, which is also applicable on basic elements of some others producers.

### Tryska VAMILA nerez | Nozzle stainless steel VAMILA

3070	Základní prvek VAMILA nerez	Basic element VAMILA stainless steel
30702	Montážní klíč VAMILA nerez – univerzál	Assembly spanner for VAMILA stainless steel – universal
3072781	Vtoková část trysky VAMILA nerez 2 x 7,8 mm	Inlet part of nozzle VAMILA stainless steel with ball 2 x 7,8 mm
3077681	Vtoková část trysky VAMILA nerez 7 x 6,8 mm	Inlet part of nozzle VAMILA stainless steel with ball 7 x 6,8 mm
307251	Vtoková část trysky VAMILA nerez Ø 25 mm	Inlet part of nozzle VAMILA stainless steel Ø 25 mm
3072783	Vtoková tryska VAMILA nerez s kuličkou 2 x 7,8 mm	Inlet nozzle VAMILA stainless steel with ball 2 x 7,8 mm
3077683	Vtoková tryska VAMILA nerez s kuličkou 7 x 6,8 mm	Inlet nozzle VAMILA stainless steel with ball 7 x 6,8 mm
307253	Vtoková tryska VAMILA nerez s kuličkou Ø 25 mm	Inlet nozzle VAMILA stainless steel with ball Ø 25 mm
307011	Uzávěr trysky VAMILA nerez	Cap nozzle VAMILA stainless steel
307021	Podlahová tryska VAMILA nerez	Bottom closing nozzle VAMILA stainless steel
307042	Vtoková mušle VAMILA nerez	Inlet shell VAMILA stainless steel
3076101	Vtoková část trysky VAMILA nerez 6 x Ø 10 mm, kolmý proud vody	Inlet part of nozzle VAMILA stainless steel 6 x Ø 10 mm, direct flow water
3076102	Vtoková část trysky VAMILA nerez 6 x Ø 8 mm, šikmý proud vody	Inlet part of nozzle VAMILA stainless steel 6 x Ø 8 mm, angled water flow
306001	Pneumatické tlačítko do základního prvku VAMILA	Pneumatic button to basic element VAMILA
306002	Piezoelektrické tlačítko do základního prvku VAMILA	Piezoelectric button to basic element VAMILA
0235623807	Trn hadicový 38 x ½" transparentní	Hose adaptor 38 x ½" transparent
30765	Vzduchový regulátor VAMILA	Air regulator VAMILA

### Trysky VAMILA ECO nerez

- ▶ Tryska je vyrobena z nerezové oceli AISI 316
- ▶ Tělo – plast PVC

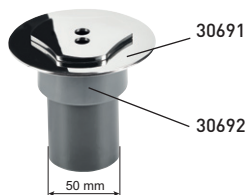

### Nozzle stainless steel VAMILA ECO

- ▶ Nozzles are made of AISI 316 stainless steel
- ▶ Body – PVC plastic



3072781



3077681

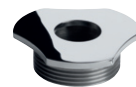

307251

### Tryska VAMILA ECO nerez | Nozzle stainless steel VAMILA ECO

30691	Nerez podložka pro vtokovou část VAMILA	Stainless steel washer for inlet nozzle VAMILA
30692	PVC přechodka k trysce VAMILA ECO – tělo, napojení 50 mm	PVC adaptor socket for inlet nozzle VAMILA ECO – body, connection 50 mm

### Sání VAMILA NEREZ

- ▶ Mřížka je vyrobena z nerezové oceli AISI 316, tělo ABS
- ▶ Napojení Ø 63 mm in/2½" ext.



313194

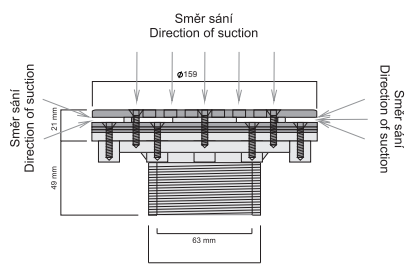

### Suction STAINLESS STEEL VAMILA

- ▶ Grating is made from stainless steel AISI 316, body ABS
- ▶ Connection glue Ø 63 mm in/2½" ext.



313196

AISI 316  
STAINLESS STEEL  
N E R E Z

### Sání VAMILA nerez | Suction stainless steel VAMILA

fólie liner	beton concrete		
313194	313195	Sání VAMILA nerez, 30 m <sup>3</sup> /h	Suction VAMILA st. steel, 30 m <sup>3</sup> /h
313196	313197	Sání VAMILA nerez, napojení Ø 63 mm in/2½" ext., 30 m <sup>3</sup> /h – jemná mřížka	Suction VAMILA st. steel, connection glue Ø 63 mm in/2½" ext., 30 m <sup>3</sup> /h – thin grating

### Podlahová výpust VAMILA NEREZ

- ▶ Mřížka nerez AISI 316
- ▶ Tělo ABS



4800273

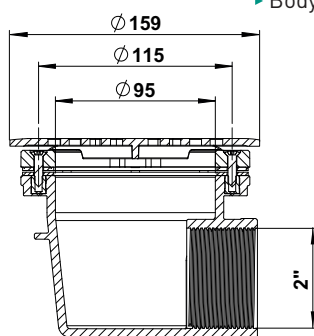

### Main drain STAINLESS STEEL VAMILA

- ▶ Grating stainless steel AISI 316
- ▶ Body ABS



4800275

AISI 316  
STAINLESS STEEL  
N E R E Z

### Podlahová výpust VAMILA nerez | Main drain stainless steel VAMILA

fólie liner		
4827814	Podlahová výpust VA, pro fólii, mosazné zástřiky M6, napojení 2" in, malá	Main drain VA, for liner pools, brass inserts M6, connection 2" in, small
4800273	Podlahová výpust VAMILA nerez, napojení 2", mosazné zástřiky	Bottom outlet VAMILA st. steel, connection 2", with brass inserts
4800275	Podlahová výpust VAMILA nerez, napojení 2", mosazné zástřiky – jemná mřížka	Bottom outlet VAMILA st. steel, connection 2", with brass inserts – thin grating

### Sání pro atrakce VAMILA



3102711



AISI 316  
STAINLESS STEEL  
N E R E Z

### Intake for attraction VAMILA

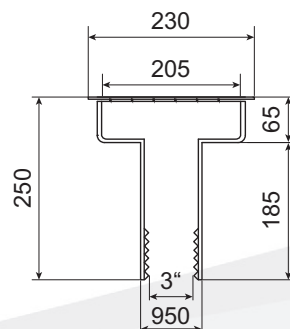

### Sání pro atrakce VAMILA | Suction for attraction VAMILA

3102711	Sání pro atrakce VAMILA, nerez	Suction for attraction VAMILA, stainless steel
---------	--------------------------------	--