

EN



---

# INSTALLATION AND USER MANUAL

---

INVERTER SWIMMING POOL HEAT PUMP

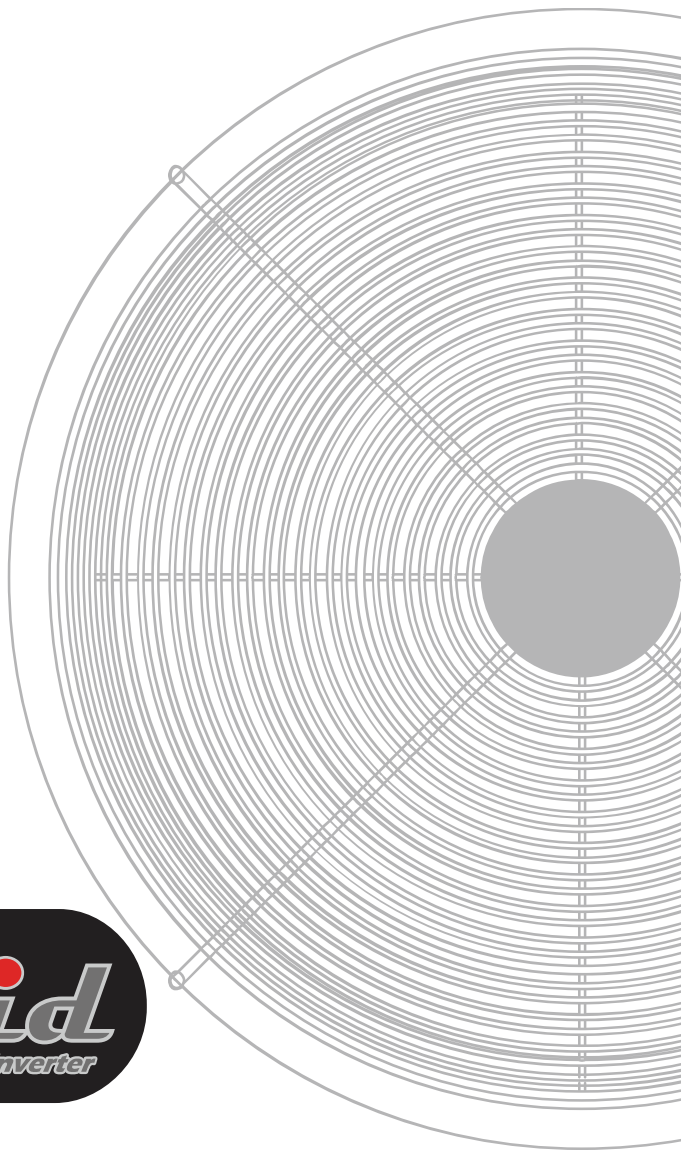

# Content

I.	Application .....	4
II.	Features .....	4
III.	Technical Parameter .....	5
IV.	Dimension .....	6
V.	Installation instruction .....	7
VI.	Operation instruction.....	11
VII.	Testing .....	13
VIII.	Precautions .....	13
IX.	Maintenance .....	15
X.	Trouble shooting for common faults .....	16
XI.	Appendix 1: Heating priority (Optional) .....	18
XII.	Appendix 2: Heating priority (Optional) .....	19



**Warning:**

- a. Please read the following tips before installation, use and maintenance.
- b. Installation, removal and maintenance must be carried out by professional personnel in accordance with the instructions.
- c. Gas leakage test must be done before and after installation.

**1. Use**

- a. It must be installed or removed by professionals, and it is forbidden to dismantle and refit without permission.
- b. **Don't put obstacles before the air inlet and outlet of the heat pump.**

**2. Installation**

- a. This product must be kept away from any source of fire.

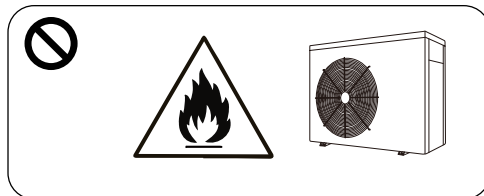

- b. The installation can't be in a closed environment or indoors, and must be kept well ventilated.

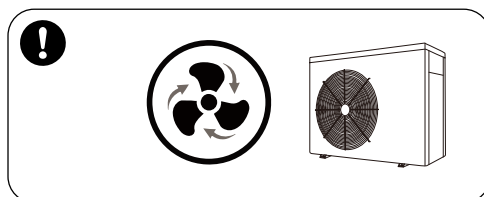

- c. Vacuum completely before welding, field welding is not allowed, welding can only be performed by professional personnel in professional maintenance center.

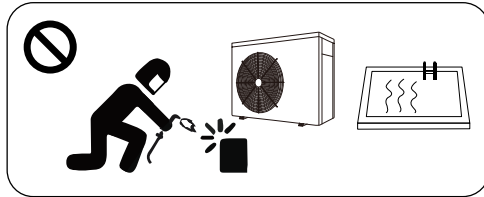

- d. Installation must be stopped if any gas leakage, and the unit must be returned to professional maintenance center.

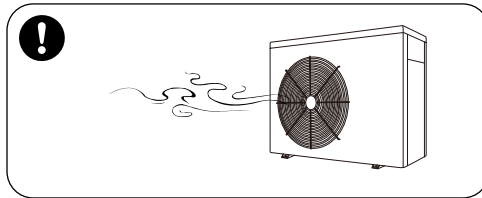

### 3. Transportation & Storage

- a. Sealing is not allowed during transportation
- b. Transporting goods at a constant speed is needed to avoid sudden acceleration or sudden braking, so as to reduce the collision of goods.
- c. The unit must be far away from any source of fire.
- d. Storage place must be bright, wide, open and good ventilation, ventilation equipment is required.

### 4. Maintenance Notice

- a. If maintenance or scrap is required, contact an authorized service center nearby
- b. Qualification requirement  
All operators who dispose gas must be qualified by valid certification which issued by professional agency.
- c. Please strictly comply with the requirement from manufacturer when maintenance or filling gas. please refer to the technical service manual.

Thank your choosing our product and your trust in our company. To help you get maximum pleasure from using this product, please read this instruction manual carefully and operate strictly according to the user manual before starting the machine, otherwise the machine may be damaged or cause you unnecessary harm.

## **I. Application**

- 1- Set swimming pool water temp efficiently and economically to provide you comfort and pleasure.
- 2- User may choose the model technical parameter according to professional guide, this series of swimming pool heater has been optimized in factory (refer to technical parameter table).

## **II. Features**

- 1- High efficient titanium heat exchanger.
- 2- Sensitive and accurate temp control and water temp display.
- 3- High pressure and low pressure protection.
- 4- Exceeding low temp auto stop protection.
- 5- Temp control compulsory defrosting.
- 6- International brand compressor.
- 7- Easy installation and operation.

### III. Technical Parameter

Model	BPNCR06	BPNCR08	BPNCR10	BPNCR13	BPNCR17	BPNCR21	BPNCR25
Advised pool volume (m <sup>3</sup> )	14~28	20~35	20~40	30~55	35~70	45~85	55~100
Operating air temperature (°C)	0~43						
<b>Performance Condition: Air 26°C, Water 26°C, Humidity 80%</b>							
Heating capacity (kW)	6.0	8.0	9.5	12.5	16.5	20.0	25.0
<b>Performance Condition: Air 15°C, Water 26°C, Humidity 70%</b>							
Heating capacity (kW)	4.3	6.0	7.0	9.0	11.5	14.0	17.0
<b>Performance Condition: Air 35°C, Water 28°C, Humidity 70%</b>							
Cooling capacity (kW)	2.2	3.3	3.8	4.9	6.3	7.7	9.5
Rated input power at air 15°C (kW)	0.29~1.0	0.34~1.4	0.35~1.6	0.36~2.1	0.57~2.7	0.62~3.4	0.70~3.95
Rated input current at air 15°C (A)	1.26~4.2	1.48~6.0	1.52~7.0	1.57~8.7	2.48~11.7	2.7~15.0	3.04~17.1
Max input current (A)	6.0	8.0	9.5	12.5	15.0	19.5	21.5
Power supply	230V/1 Ph/50Hz						
Advised water flux (m <sup>3</sup> /h)	2~4	2~4	3~4	4~6	6~8	8~10	10~12
Water pipe in-out Spec (mm)	50						
Net Dimension LxWxH (mm)	744x359x 648	864x359x 648	864x359x 648	864x359x 648	954x359x 648	954x359x 748	1084x429x 948
Net Weight (kg)	42	46	47	49	60	68	90

#### Notice:

1. This product can work well under air temp 0°C ~ +43°C, efficiency will not be guaranteed out of this range. Please take into consideration that the pool heater performance and parameters are different under various conditions.
2. Related parameters are subject to adjustment periodically for technical improvement without further notice. For details please refer to nameplate.

## IV. Dimension

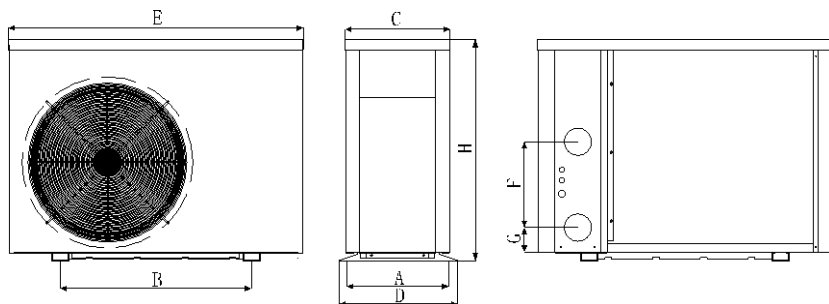

UNIT=MM		A	B	C	D	E	F	G	H
<b>MODEL</b>	<b>BPNCR06</b>	334	490	318	359	744	330	74	648
	<b>BPNCR08</b>	334	560	318	359	864	250	74	648
	<b>BPNCR10</b>	334	560	318	359	864	250	74	648
	<b>BPNCR13</b>	334	560	318	359	864	290	74	648
	<b>BPNCR17</b>	334	590	318	359	954	350	74	648
	<b>BPNCR21</b>	334	590	318	359	954	390	74	748
	<b>BPNCR25</b>	395	720	392	420	1092	620	74	958

※ Above data is subject to modification without notice.

### Note:

The picture above is the specification diagram of the pool heater, for technician's installation and layout reference only. The product is subject to adjustment periodically for improvement without further notice.

# V. Installation instruction

## 1. Drawing for water pipes connection

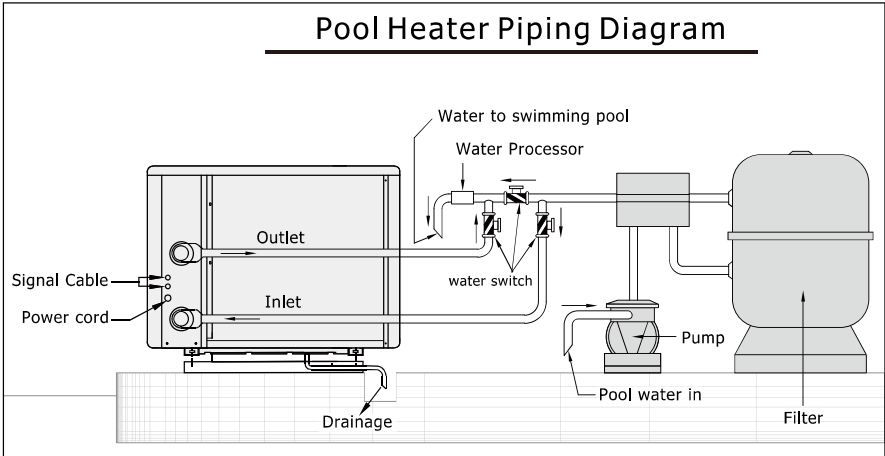

*(Notice: The drawing is just for demonstration, and layout of the pipes is only for reference.)*

## 2. Connecting your power wire

The diagrams show the following steps:

1. The heater is shown with the right side panel being tilted away from the unit.
2. The right side panel is fully detached, revealing the internal electrical components.
3. The lower half of the right side panel is removed, showing the electrical box cover.
4. The electrical box cover is unscrewed, revealing the terminal block.

**1 2 3**

- ① Please use cross screwdriver to take off the 2 screws at the bottom of the right side panel. Take off the lower half of the panel.
- ② Unscrew the 3 screws on the cover of the electrical box.
- ③ Connect the terminals according to the electrical diagram.

*(Note: please open the back panel for power connection. The operation is the same as above.)*



For power supply: 230V 50Hz

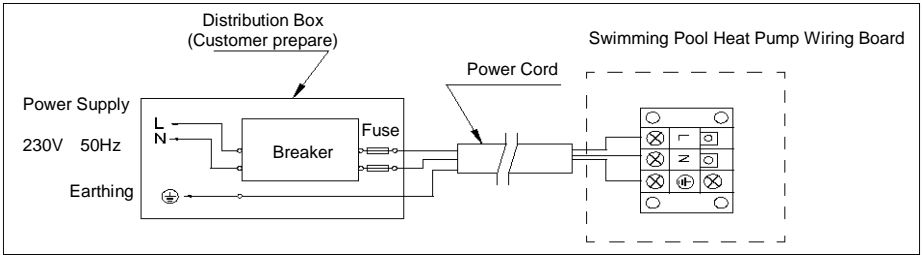

Note:

- ⚠ Must be hard wired, no plug allowed
- ⚠ The swimming pool heater must be earthed well.

### 3. Electric Wiring Diagram

#### Options for protecting devices and cable specification

MODEL		BPNCR06	BPNCR08	BPNCR10	BPNCR13	BPNCR17	BPNCR21	BPNCR25
Breaker	Rated Current A	8.0	9.5	11.5	15.0	18.0	23.0	25.0
	Rated Residual Action Current mA	30	30	30	30	30	30	30
Fuse	A	8.0	9.5	11.5	15.0	18.0	23.0	25.0
Power Cord	(mm <sup>2</sup> )	3×1.5	3×1.5	3×2.5	3×2.5	3×4	3×4	3×6
Signal cable	(mm <sup>2</sup> )	3×0.5	3×0.5	3×0.5	3×0.5	3×0.5	3×0.5	3×0.5

※ Above data is subject to modification without notice.

**Note:** The above data is adapted to power cord ≤ 10m. If power cord is > 10m, wire diameter must be increased. The signal cable can be extended to 50m at most.

### 4. Installation instruction and requirement

The heat pump must be installed by a professional team. The users are not qualified to install by themselves, otherwise the heat pump might be damaged and risky for users' safety.

## A. Installation

1) The inlet and outlet water unions can't bear the weight of soft pipes. The heat pump must be connected with hard pipes!

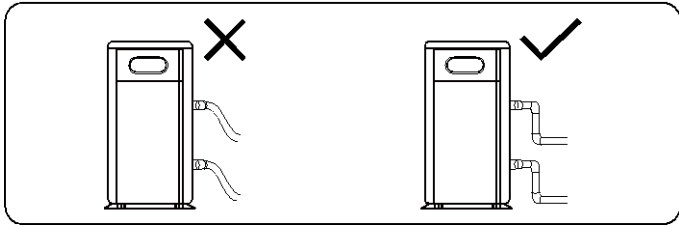

2) In order to guarantee the heating efficiency, the water pipe length should be  $\leq 10\text{m}$  between the pool and the heat pump.

## B. Installation instruction

1) Location and size

**⚠** The heat pump should be installed in a place with good ventilation

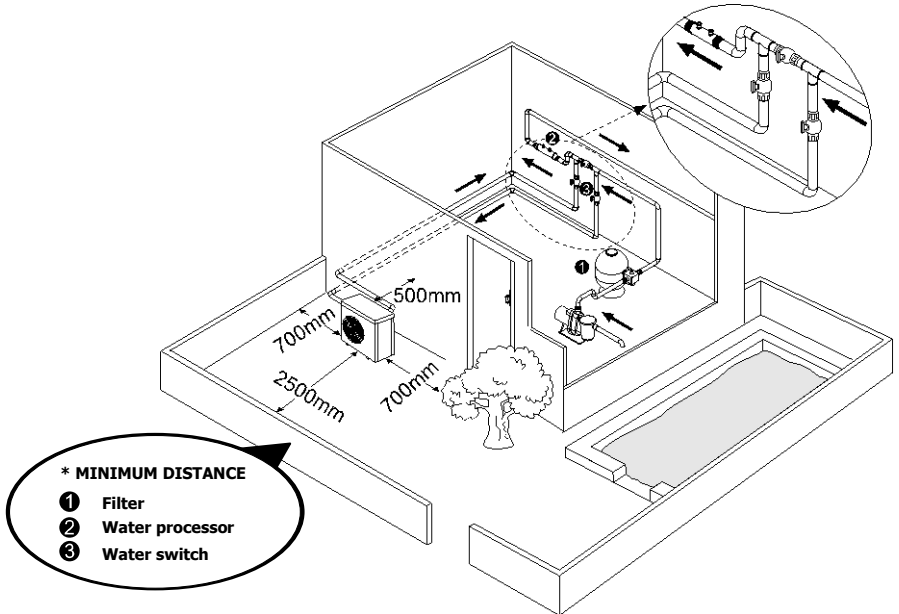

2) The frame must be fixed by bolts (M10) to concrete foundation or brackets. The concrete foundation must be solid and fastened; the

bracket must be strong enough antirust treated;

3) Please don't stack substances that will block air flow near inlet or outlet area, and there is no barrier within 50cm behind the main machine, or the efficiency of the heater will be reduced or even stopped;

4) The machine needs an appended pump (Supplied by the user). The recommended pump specification-flux: refer to Technical Parameter, Max. lift  $\geq 10\text{m}$ ;

5) When the machine is running, there will be condensation water discharged from the bottom, please pay attention to it. Please hold the drainage nozzle (accessory) into the hole and clip it well, and then connect a pipe to drain the condensation water out.

### **C. Wiring**

- 1) Connect to appropriate power supply, the voltage should comply with the rated voltage of the products.
- 2) Earth the machine well.
- 3) Wiring must be handled by a professional technician according to the circuit diagram.
- 4) Set leakage protector according to the local code for wiring (leakage operating current  $\leq 30\text{mA}$ ).
- 5) The layout of power cable and signal cable should be orderly and not affecting each other.

### **D. Switch on after finishing all wiring construction and re-checking.**

# VI. Operation instruction

## Picture for keys

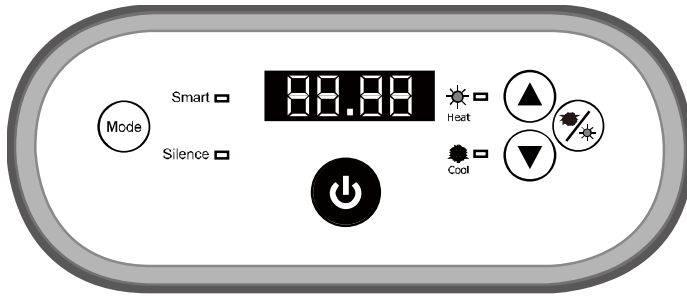





SYMBOL	DESIGNATION	OPERATION
	Power ON/OFF	Press to power on or off the heat pump
	Mode	Press to select Smart/Silence mode
	Heat/Cool/Auto	Press to shift among cooling, heating and auto
	Up/ Down	Press to set desired water temperature

### Note:



- ✧ You may set the desired water temperature from 12 to 35°C.
- ✧ The on the right shows the inlet water temperature. The on the left shows the set temperature by pressing or button.
- ✧ After you turn on the heat pump, the fan will start to run in 3 minutes. In another 30 seconds, the compressor will start to run.
- ✧ During heating, the will be light. During cooling, will be light. During auto heating cooling, and will be both light.

### 2.2.1. Mode selections

- ✧ Smart  will be light as standard when you turn on the heat pump.
- ✧ Press the  button to enter the Silence mode, the Silence  will be light.

Press the  button again to exit and enter the SMART mode.

### 2.2.2. Compulsory defrosting

- ✧ When the heat pump is heating and the compressor is working continuously for 10 minutes, press both "" and "" buttons for 5 seconds to start compulsory defrosting. (Note: the interval between compulsory defrosting should be more than 30 minutes.)
- ✧ The heating light will be twinkling when heat pump is in compulsory or auto defrosting.
- ✧ The running process and ending of compulsory defrosting are the same as auto-defrosting.

## **VII. Testing**

### **1. Inspection before use**

- A. Check installation of the whole machine and the pipe connections according to the pipe connecting drawing;
- B. Check the electric wiring according to the electric wiring diagram and earthing connection;
- C. Make sure that the main machine power switch is off;
- D. Check the temperature setting;
- E. Check the air inlet and outlet.

### **2. Trial**

- A. The user must "Start the Pump before the Machine, and Turn off the Machine before the Pump", or the machine will be damaged;
- B. The user should start the pump, check for any leakage of water; and then set suitable temperature in the thermostat, and then switch on power supply;
- C. In order to protect the swimming pool heater, the machine is equipped with a time lag starting function, when starting the machine, the blower will run 1 minutes earlier than the compressor;
- D. After the swimming pool heater starts up, check for any abnormal noise from the machine.

## **VIII. Precautions**

### **1. Attention**

- A. Set proper temperature in order to get comfortable water temperature to avoid overheating or overcooling;
- B. Please don't stack substances that can block air flow near inlet or outlet area, or the efficiency of the heater will be reduced or even

stopped;

- C. Please don't put hands into outlet of the swimming pool heater, and don't remove the screen of the fan at any time;
- D. If there are abnormal conditions such as noise, smell, smoke and electrical leakage, please switch off the machine immediately and contact the local dealer. Don't try to repair it yourself;
- E. Don't use or stock combustible gas or liquid such as thinners, paint and fuel to avoid fire;
- F. In order to optimize the heating effect, please install heat preservation insulation on pipes between swimming pool and the heater. During running period of the swimming pool heater, please use a recommended cover on the swimming pool;
- G. Connecting pipes of the swimming pool and the heater should be  $\leq 10\text{m}$ , or the heating effect of the heater cannot be ensured;
- H. This series of machines can achieve high efficiency under air temperature of  $+15^{\circ}\text{C}\sim+25^{\circ}\text{C}$ .

## **2. Safety**

- A. Please keep the main power supply switch far away from the children;
- B. When a power cut happens during running, and later the power is restored, the heater will start up automatically. So please switch off the power supply when there is a power cut, and reset temp when power is restored;
- C. Please switch off the main power supply in lightning and storm weather to prevent from machine damage that caused by lightning;
- D. If the machine is stopped for a long time, please cut off the power supply and drain water clear of the machine by opening the tap of inlet pipe.

## IX. Maintenance

### Caution: Danger of electric shock

“Cut off” power supply of the heater before cleaning, examination and repairing

- A. In winter season when you don't swim:
1. Cut off power supply to prevent any machine damage
  2. Drain water clear of the machine.

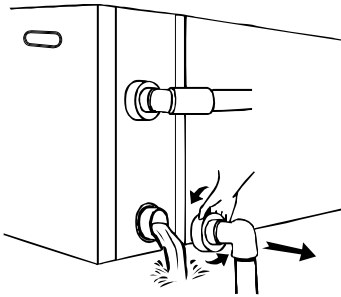

### **!!Important:**

Unscrew the water nozzle of inlet pipe to let the water flow out.

*When the water in machine freezes in winter season, the titanium heat exchanger may be damaged.*

3. Cover the machine body when not in use.
- B. Please clean this machine with household detergents or clean water, NEVER use gasoline, thinners or any similar fuel.
- C. Check bolts, cables and connections regularly.



## X. Trouble shooting for common faults

FAILURE	REASON	SOLUTION
<b>Heat pump doesn't run</b>	No power	Wait until the power recovers
	Power switch is off	Switch on the power
	Fuse burned	Check and change the fuse
	The breaker is off	Check and turn on the breaker
<b>Fan running but with insufficient heating</b>	evaporator blocked	Remove the obstacles
	Air outlet blocked	Remove the obstacles
	3 minutes start delay	Wait patiently
<b>Display normal, but no heating</b>	Set temp. too low	Set proper heating temp.
	3 minutes start delay	Wait patiently
If above solutions don't work, please contact your installer with detailed information and your model number. Don't try to repair it yourself.		

**Note:** If the following conditions happen, please stop the machine immediately, and cut off the power supply immediately, then contact your dealer:

- a) Inaccurate switch action;
- b) The fuse is frequently broken or leakage circuit breaker jumped.

## Failure code

NO.	DISPLAY	NOT FAILURE DESCRIPTION
1	E3	No water protection
2	E5	Power supply excesses operation range
3	E6	Excessive temp difference between inlet and outlet water(Insufficient water flow protection)
4	Eb	Ambient temperature too high or too low protection
5	Ed	Anti-freezing reminder
NO.	DISPLAY	FAILURE DESCRIPTION
1	E1	High pressure protection
2	E2	Low pressure protection
3	E4	3 phase sequence protection (three phase only)
4	E7	Water outlet temp too high or too low protection
5	E8	High exhaust temp protection
6	EA	Evaporator overheat protection (only at cooling mode)
7	P0	Controller communication failure
8	P1	Water inlet temp sensor failure
9	P2	Water outlet temp sensor failure
10	P3	Gas exhaust temp sensor failure
11	P4	Evaporator coil pipe temp sensor failure
12	P5	Gas return temp sensor failure
13	P6	Cooling coil pipe temp sensor failure
14	P7	Ambient temp sensor failure
15	P8	Cooling plate sensor failure
16	P9	Current sensor failure
17	PA	Restart memory failure
18	F1	Compressor drive module failure
19	F2	PFC module failure
20	F3	Compressor start failure
21	F4	Compressor running failure
22	F5	Inverter board over current protection
23	F6	Inverter board overheat protection
24	F7	Current protection
25	F8	Cooling plate overheat protection
26	F9	Fan motor failure
27	Fb	Power filter plate No-power protection
28	FA	PFC module over current protection

# XI. Appendix 1: Heating priority (Optional)

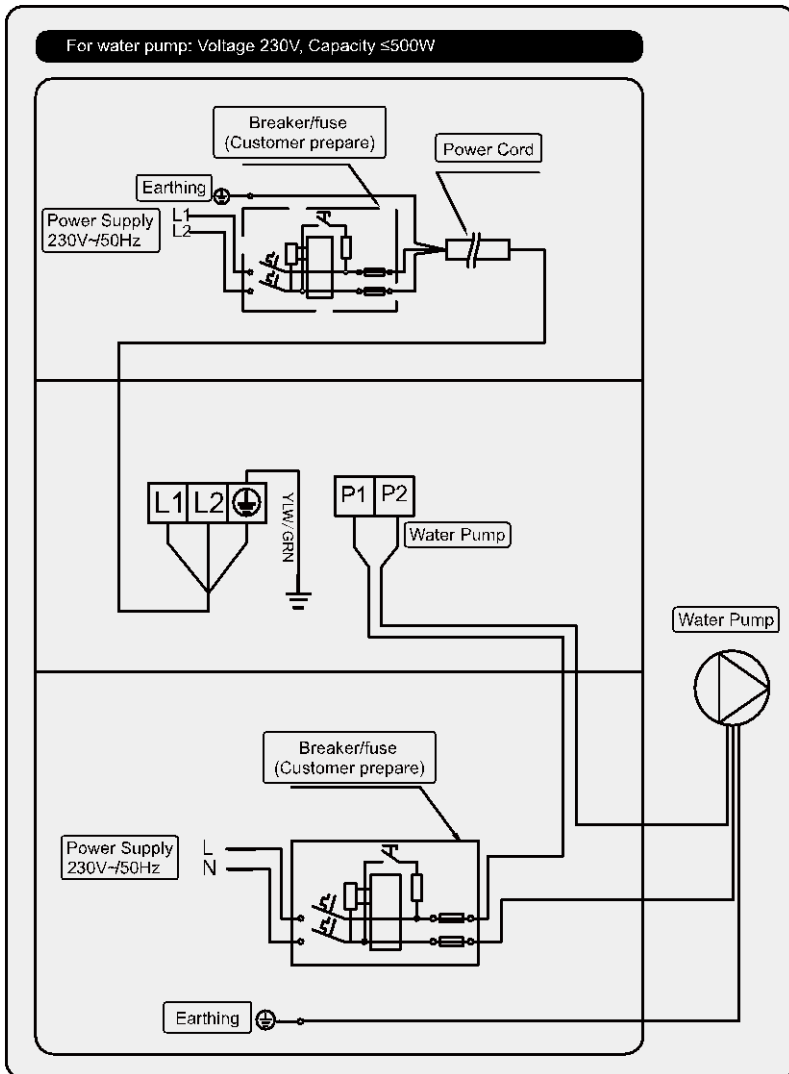

## XII. Appendix 2: Heating priority (Optional)

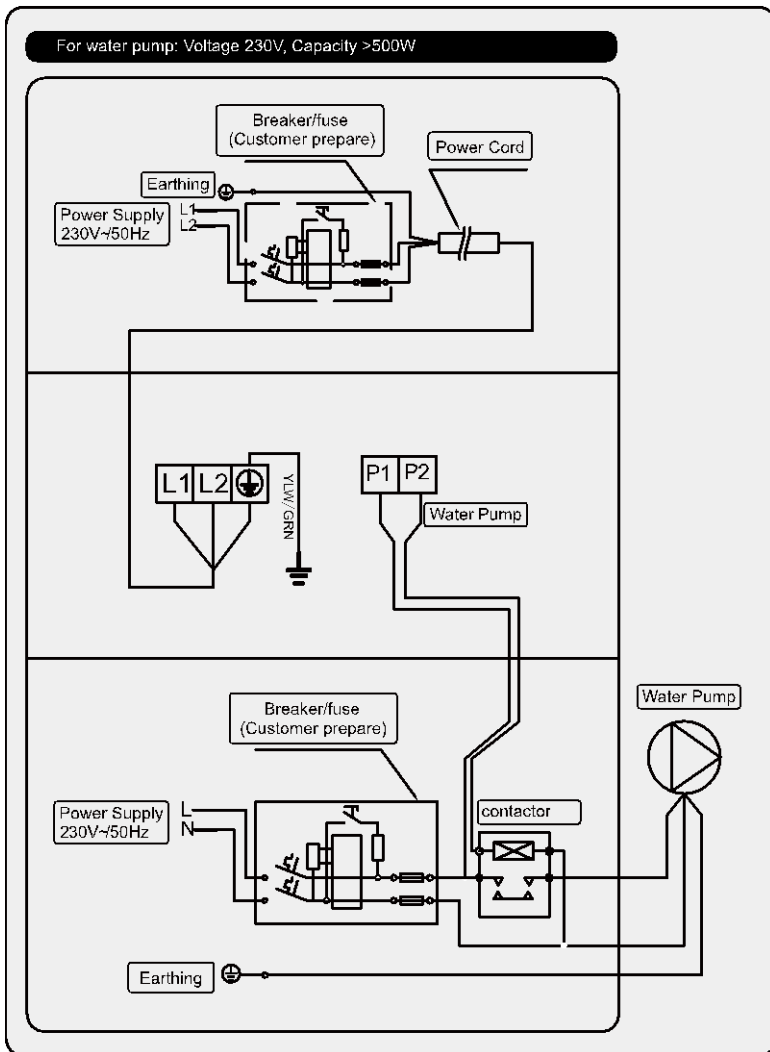

## Parallel connection with filtration clock

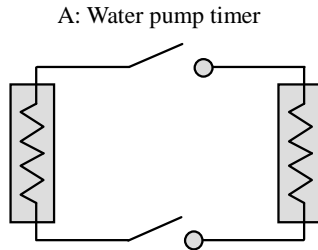

B: Water pump wiring of Heat Pump

Note: The installer should connect A parallel with B (as above picture). To start the water pump, condition A or B is connected. To stop the water pump, both A and B should be disconnected.

