

**VAGNER**  
POOL

CZ

GB



VODNÍ CLONY  
CASCADE SHOWERS



Váš prodejce:

## • Vodní atrakce –chrliče

- Ručně leštěné = vysoká kvalita lesku
- Přesnost a kvalita provedení
- Snadná montáž pomocí přípojovací rychlospojky
- Napojení:  $\varnothing$  75 mm



770015

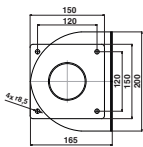
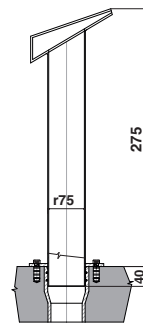

770016

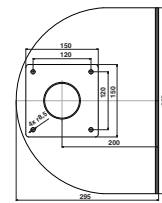
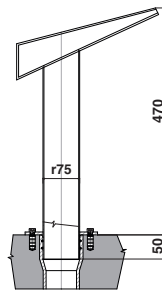

770014

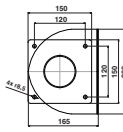
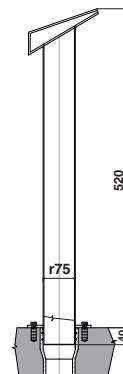

770004

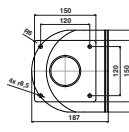
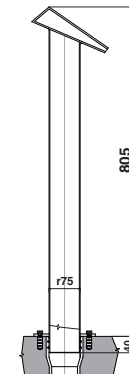

770012

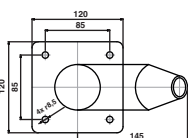
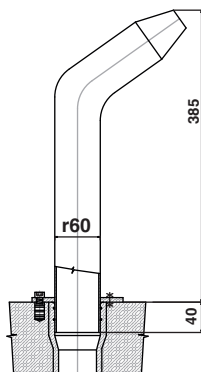

770013

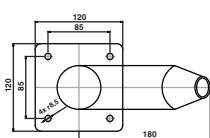
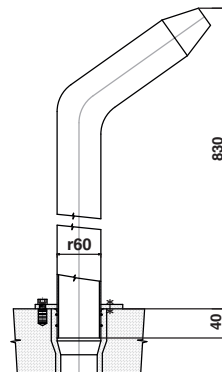

7709

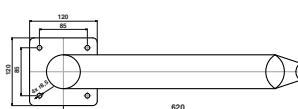
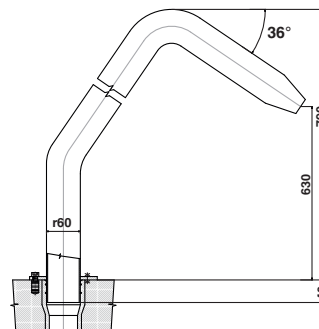

7712

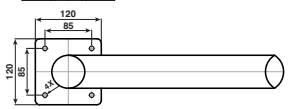
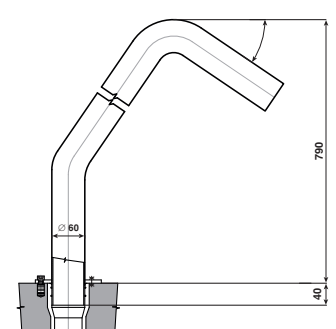

## • Water attraction – cascade showers

- Manual polishing = high-quality gloss
- Accuracy and quality of design
- Easy assembly with fast connection
- Connection:  $\varnothing$  75 mm



7705



77044

7704



7711



7710

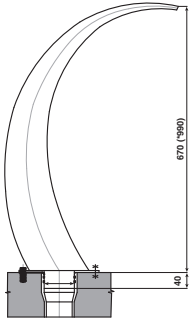

\* Rozměr pro Maxi Kobra

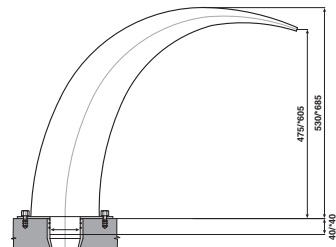

\* Rozměr pro Maxi Delfin

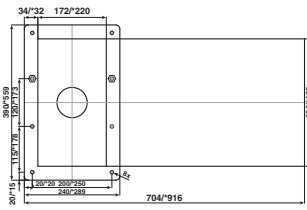
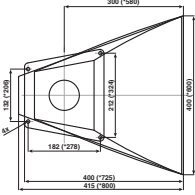
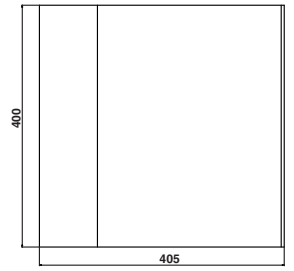
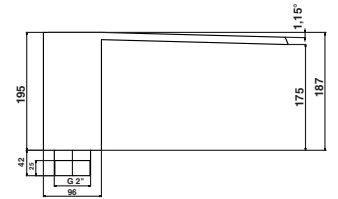
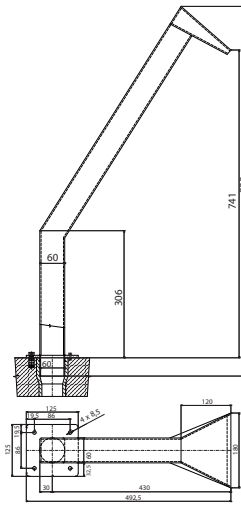

77081 - LESK



77066



7706



7700177



770017

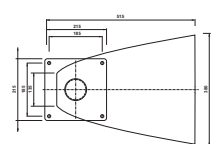
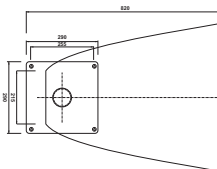
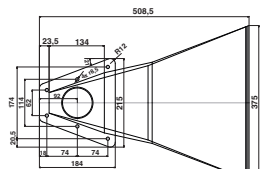
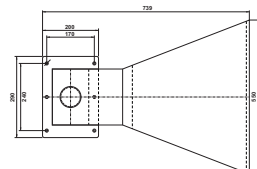
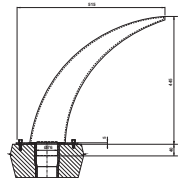
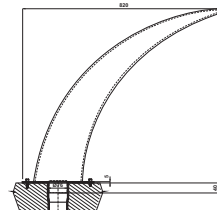
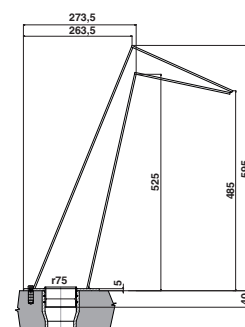
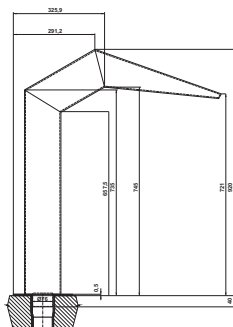
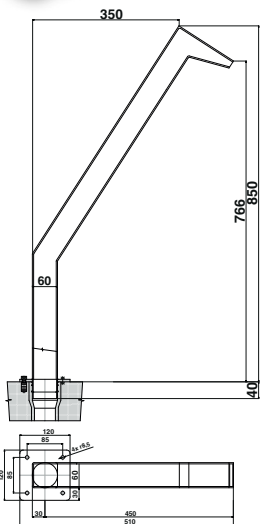

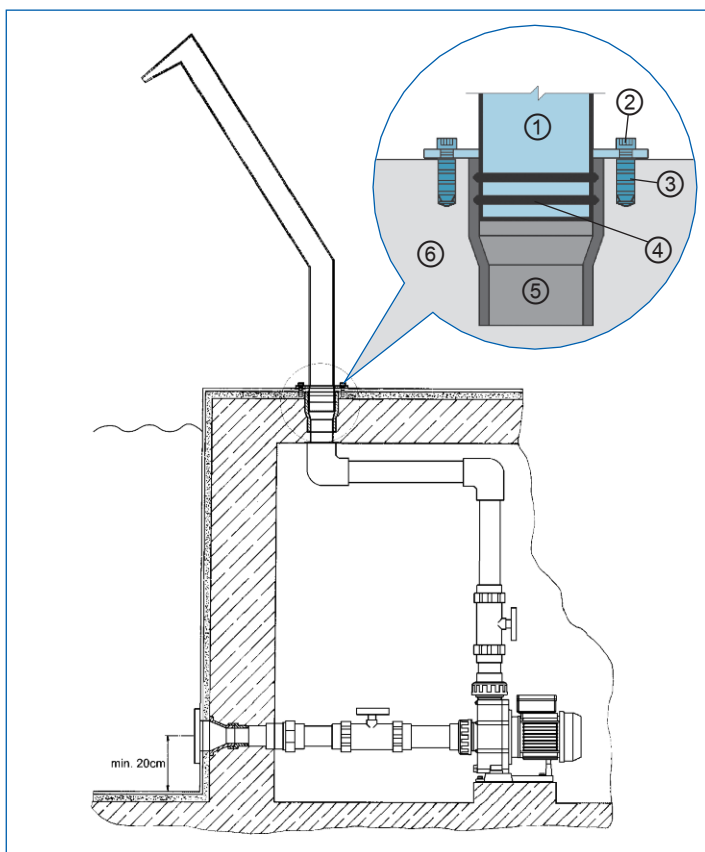

- ① tělo chrliče – nerez  
cascade shower body – st. steel
- ② A vřut nerez 8 x 100 mm  
screw st. steel 8 x 100 mm  
B\*šroub nerez M8 x 30 mm  
screw bolt st. steel M8 x 30 mm
- ③ A hmoždinka 14 x 75 mm  
wall plug 14 x 75 mm  
B\*kotva nerez 12 x 80 mm  
anchor st. steel 12 x 80 mm
- ④ gumové těsnění (O-kroužek)  
rubber gasket (O-ring)
- ⑤ rychlospojka Ø 63 nebo 75 mm  
easy coupler Ø 63 or 75 mm
- ⑥ beton  
concrete

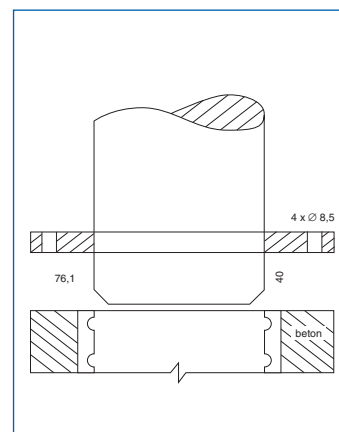

\*Pouze na objednávání  
\*Upon order only



Kód Code	Název chrliče Cascade shower name	Proud vody Flow of water	Materiál Material	Povrch Surface	Napojení chrlič/potrubicí Connection cascade shower/piping	Průtok Flow
770004	půlměsíc vysoký tall halfmoon	↓	nerez AISI 316 st. steel AISI 316	lesklý povrch polished surface	75 mm/63 mm	9–24 m³/h
770012	píšťala nízká short pipe	↑	nerez AISI 316 st. steel AISI 316	lesklý povrch polished surface	63 mm/50 mm	6–9 m³/h
770013	píšťala vysoká tall pipe	↑	nerez AISI 316 st. steel AISI 316	lesklý povrch polished surface	63 mm/50 mm	6–9 m³/h
770014	půlměsíc vysoký tall halfmoon	↑	nerez AISI 316 st. steel AISI 316	lesklý povrch polished surface	75 mm/63 mm	6–16 m³/h
770015	půlměsíc nízký short halfmoon	↑	nerez AISI 316 st. steel AISI 316	lesklý povrch polished surface	75 mm/63 mm	6–16 m³/h
770016	půlměsíc široký wide halfmoon	↑	nerez AISI 316 st. steel AISI 316	lesklý povrch polished surface	75 mm/63 mm	9–24 m³/h
7704	„Delfín“ / „Dolphin“	↓	nerez AISI 316 st. steel AISI 316	lesklý povrch polished surface	75 mm/63 mm	9–32 m³/h
77044	„Maxi Delfín“ / „Maxi Dolphin“	↓	nerez AISI 316 st. steel AISI 316	lesklý povrch polished surface	75 mm/63 mm	9–32 m³/h
7705	„Kobra“ / „Cobra“	↓	nerez AISI 316 st. steel AISI 316	lesklý povrch polished surface	75 mm/63 mm	9–32 m³/h
7706	„Kubista“ / „Cubist“	↓	nerez AISI 316 st. steel AISI 316	matný povrch matt surface	75 mm/63 mm	9–32 m³/h
77066	Maxi Kubista“ / „Maxi Cubista“	↓	nerez AISI 316 st. steel AISI 316	matný povrch matt surface	75 mm/63 mm	9–32 m³/h
77081	„Žirafa“ „Giraffe“	↓	nerez AISI 316 st. steel AISI 316	lesklý povrch polished surface	63 mm/50 mm	6–16 m³/h
7709	„Saxofon“ „Saxofon“	↓	nerez AISI 316 st. steel AISI 316	lesklý povrch polished surface	63 mm/50 mm	6–16 m³/h
7710	„Do zdi“ „For assembly to a wall“	↓	nerez AISI 316 st. steel AISI 316	lesklý povrch polished surface	2" ext. závit 2" ext. thread	6–16 m³/h
7711	„Kačer“ „Duck“	↓	nerez AISI 316 st. steel AISI 316	lesklý povrch polished surface	63 mm/50 mm	6–16 m³/h
7712	„Saxofon sprcha“ „Saxofon shower“	↓	nerez AISI 316 st. steel AISI 316	lesklý povrch polished surface	63 mm/50 mm	6–16 m³/h
770017	„Vlna“ / „Wave“	↑	nerez AISI 316 st. steel AISI 316	lesklý povrch polished surface	75 mm/63 mm	9–32 m³/h
7700177	„Maxi Vlna“ / „Maxi wave“	↑	nerez AISI 316 st. steel AISI 316	lesklý povrch polished surface	75 mm/63 mm	9–32 m³/h