

pH Link

Dual Link

Instructions for installation and use - English
pH regulation - Redox regulation
Translation of the original instructions in french

EN



More documents on:
www.zodiac.com

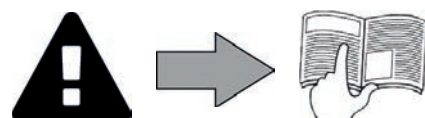

WARNINGS

GENERAL WARNINGS

- Failure to respect the warnings may cause serious damage to the pool equipment or cause serious injury, even death.
- Only a person qualified in the technical fields concerned (electricity, hydraulics or refrigeration) is authorised to perform this procedure. The qualified technician working on the appliance must use/wear personal protective equipment (such as safety goggles and protective gloves, etc.) in order to reduce the risk of injury occurring when working on the appliance.
- Before servicing the appliance, ensure that it is switched off and isolated from the power supply circuit.
- The appliance is intended to be used only for swimming pools and spas; it must not be used for any purpose other than that for which it has been designed.
- It is important that the appliance is operated by people who are competent and qualified (both physically and mentally), after having read the instructions for use. Persons not meeting these criteria should not be allowed access to the appliance in order to prevent risk of property damage or injury, including loss of life.
- Keep the appliance out of the reach of children.
- The appliance must be installed according to the manufacturer's instructions and in compliance with all applicable local and national standards. The installer is responsible for installing the appliance and for compliance with national installation regulations. Under no circumstances may the manufacturer be held liable in the event of failure to comply with applicable local installation standards.
- For any work other than the simple user maintenance described in this manual, the product should be referred to a qualified professional.
- Incorrect installation and/or use may cause serious damage to property or serious injuries (possibly causing death).
- All equipment, even postage and packing paid, travels at the risks and perils of the recipient. The latter shall issue reserves in writing on the carrier's delivery slip if damage is detected, caused during transport (confirmation to be sent to the carrier within 48 hours by registered letter). In the event that an appliance containing coolant has been turned on its side, mention your reservations in writing to the carrier.
- If the appliance suffers a malfunction, do not try to repair it yourself; instead contact a qualified technician.
- Refer to the warranty conditions for details of the permitted water balance values for operating the appliance.
- In addition to using spare parts manufactured by unauthorised third-party manufacturers, deactivating, eliminating or bypassing any of the safety mechanisms integral to the appliance, will automatically void the warranty.
- Do not spray insecticide or any other chemical (inflammable or non-inflammable) in the direction of the appliance, as this may damage the body and cause a fire.
- Zodiac® heat pump, filtration pump and filter appliances are compatible with the most commonly used types of pool water treatment systems.
- Do not touch the fan and/or any moving parts and do not insert anything, including your fingers in the vicinity of the moving parts while the appliance is in operation.



WARNINGS ASSOCIATED WITH ELECTRICAL APPLIANCES

- The electrical supply to the appliance must be protected by a dedicated 30 mA differential residual current protection device (RCD), complying with the standards and regulations in force in the country where it is installed.
- Do not use an extension cord to plug in the appliance; connect the appliance directly to a suitable power supply circuit.
- Before carrying out any operations, check that:
 - The voltage indicated on the rating plate of the appliance corresponds to the mains voltage,
 - The power grid is adapted to the power requirements of the appliance, and is grounded.
 - The plug (where applicable) is suitable for the socket.
- In the event of abnormal function or signs of overheating such as a burning odour from the appliance, turn it off immediately, unplug / disconnect it from its power supply and contact a professional.
- Before accessing the enclosure for any reason, ensure that all power to the appliance and also power to any accessories or external devices which may be connected to the appliance, is disconnected from the mains power supply.
- Do not disconnect and reconnect the appliance to the power supply when in operation.
- Do not pull on the power cord to disconnect it from the power supply.
- If the supply cord is damaged, it must be replaced by the manufacturer, its service agent or similarly qualified persons in order to avoid a hazard.
- Do not attempt to carry out any servicing or maintenance operations with wet hands or while the appliance is wet.
- Ensure that all terminals for mains power are in good condition and free of corrosion and/or dirt/debris.
- For any component or sub-assembly containing a battery: do not recharge or dismantle the battery, or throw it into a fire. Do not expose it to high temperatures or direct sunlight.
- In stormy weather, disconnect the appliance from the power supply to prevent it from suffering lightning damage.
- Do not immerse the appliance in water (with the exception of cleaners) or mud.

Recycling



This symbol means that your appliance must not be thrown into a normal bin. It will be selectively collected for the purpose of reuse, recycling or transformation. Any substances it may contain which are potentially dangerous to the environment shall be eliminated or neutralised.

Request information on recycling procedures from your retailer.

Contents

<u>1. Information before installing</u>	3
1.1 Contents	3
1.2 Technical specifications	3
<u>2. Installation</u>	4
2.1 Preparing the pool: water balance	4
2.2 Installing the pH Link or Dual Link module.....	5
2.3 Installing the POD Kit	5
<u>3. Use</u>	8
3.1 Activating the module.....	8
3.2 Display	8
3.3 Calibrating the sensor(s)	9
3.4 Adjusting the set point(s).....	10
3.5 Setting the pool volume	10
3.6 Peristaltic pump	11
<u>4. Maintenance</u>	12
4.1 Cleaning the sensor(s).....	12
4.2 Winterizing	13
<u>5. Troubleshooting</u>	13
<u>6. Product conformity</u>	14









1. Information before installing

1.1 Contents

1.1.1 pH Link module

			
pH Link module	POD kit	pH sensor	Buffer solution pH 7.5
			
Accessory bag (counterweight + securing clip, PTFE tape and stoppers)		suction + injection hose (5 meters)	Hole saw, 22 mm

1.1.2 Dual Link module

				
Dual Link module	POD kit	pH sensor	ACL sensor	Hole saw, 22 mm
				
Accessory bag (counterweight + securing clip, PTFE tape and stoppers)		suction + injection hose (5 meters)	Buffer solution pH 7.5	Buffer solution 700 mV

1.2 Technical specifications

	pH Link module	Dual Link module
Supply voltage	Low voltage (connected to the power pack)	
Peristaltic pump flow rate	1.8 L/h	
Maximum back pressure (injection)	1.5 bar	
pH and ACL sensor type	combined, ABS 1/2" NPT threaded body (pH = blue / ACL = red)	
pH and ACL sensor electrolyte	KCl polymer	
pH and ACL sensor cable(s)	1.5 meters shielded, BNC plug (pH = blue / ACL = red)	
pH correction	acid (pH minus only)	

	pH Link module	Dual Link module
pH minus dosage	Proportional cyclic	
pH sensor tolerances	Flow speed 2 metres/second - 5 bar / 60°C	
Measurement scale & pH sensor accuracy	pH 0.0 to pH 12.0, ± 0.1 pH	
pH sensor calibration	1 point, pH 7.5	
ACL sensor tolerances	/	Flow speed 2 metres/second - 5 bar / 60°C
	/	10 ppm maximum (shock chlorination)
Measurement scale & ACL sensor accuracy	/	100 mV to 1000 mV / ± 10 mV
ACL sensor calibration	/	1 point, 700 mV
pH and ACL sensor response time	< 15 seconds	
Dimensions (w x h x d)	28.5 x 15.5 x 7.5 cm	
Weight (module only)	1 kg	
Protection index	IP23	

EN

2. Installation

2.1 Preparing the pool: water balance

The Zodiac® electrolyser or hydroxinator are designed to disinfect pool water.

With the pH Link module, it automatically maintains the pH value of your pool.

With the Dual Link module (electrolyser only), it automatically maintains the pH value and chlorine level (ACL or Redox potential) of your pool.

It is essential that the pool water balance is controlled and adjusted before installing the appliance. Making sure that the pool water balance is correct from the very start will reduce the likelihood of encountering problems on the first days of operation or during the season the pool is in use.



Even if it is an automatic control system, it is essential to analyse the water regularly to check the water balance parameters.

	Unit	Recommended values	To increase	To reduce	Test frequency (in the season)
pH	/	7.2 – 7.4	Deactivate dosage or add pH+	Automatic (pH minus Perfect pH- or pH-)	Weekly
Free chlorine	mg/L or ppm	0.5 – 2	Increase ACL set point or add chlorine	Decrease ACL set point or turn off the unit	Weekly
TAC (alkalinity or buffering power)	°f (ppm)	8 – 15 (80 – 150)	Add alkaline corrector (Alca+ or TAC+)	Add hydrochloric acid	Monthly
TH (calcium hardness)	°f (ppm)	10 – 30 (100 – 300)	Add calcium	Add a calcium carbonate sequestering agent (Calci-) or carry out carbonate removal	Monthly
Cyanuric acid (stabiliser)	mg/L or ppm	< 30	/	Partially empty the pool and refill it	Quarterly
Metals (Cu, Fe, Mn...)	mg/L or ppm	± 0	/	Add a metal fixer (Metal Free)	Quarterly

2.2 Installing the pH Link or Dual Link module

- Turn off your power pack then the filtration by cutting off the main electricity supply in order to isolate the installation.
- Close the isolating valves in the pipework.
- Remove the silver cover by pressing the sides and raising it (1), then unscrew the four screws attaching the original (empty) lower module to the power pack (2).
- Remove the empty module (3).
- Unpack and connect the BNC cable from the pH sensor to the module (4).
- Position the BNC plug on the screw head (5), then connect the module ribbon (6).
- Remove the BNC cable (7).
- Put the pH Link or Dual Link module in position, replace the four screws and replace the silver cover.

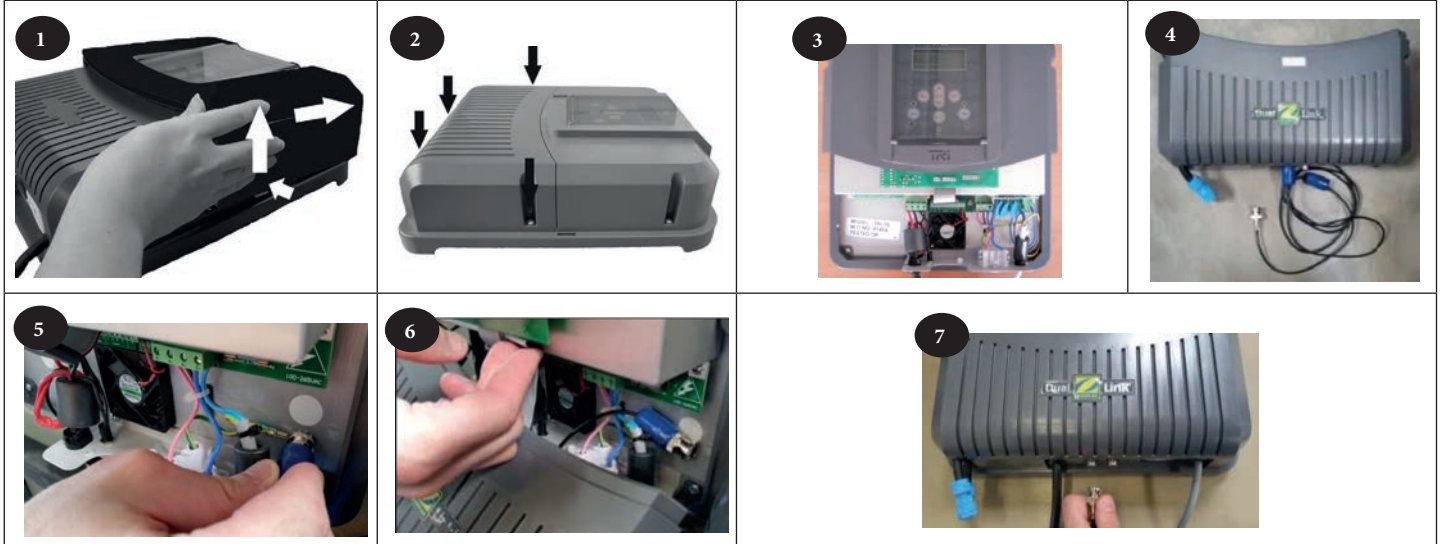

- Do not reconnect the electricity supply until the pH Link or Dual Link module, the sensor-holding POD Kit and the pH minus injection pipe have been installed (see “2.3.3 Installing the pH minus injection line”).

2.3 Installing the POD Kit

The sensor-holding POD Kit is a single assembly including the flow rate detector (used by your appliance, see “2.3.2 Installing the flow switch”), the pH and ACL sensors and pH minus injection.



- The cell bypass valves must always be open.
- The sensor-holding POD Kit must always be positioned on a horizontal pipe so that the sensors are vertical (1 or 2).
- The POD Kit must be the first unit fitted after the pool filter.
- If the pool is fitted with a heating system (heat pump, heat exchanger, electric heater, etc.), the POD Kit must be installed before it (3) (to take readings on unheated water).
- We recommend positioning the POD Kit more than 20 cm from an elbow in the pipe.
- The sensor cables must not be positioned near high voltage mains electricity cables.

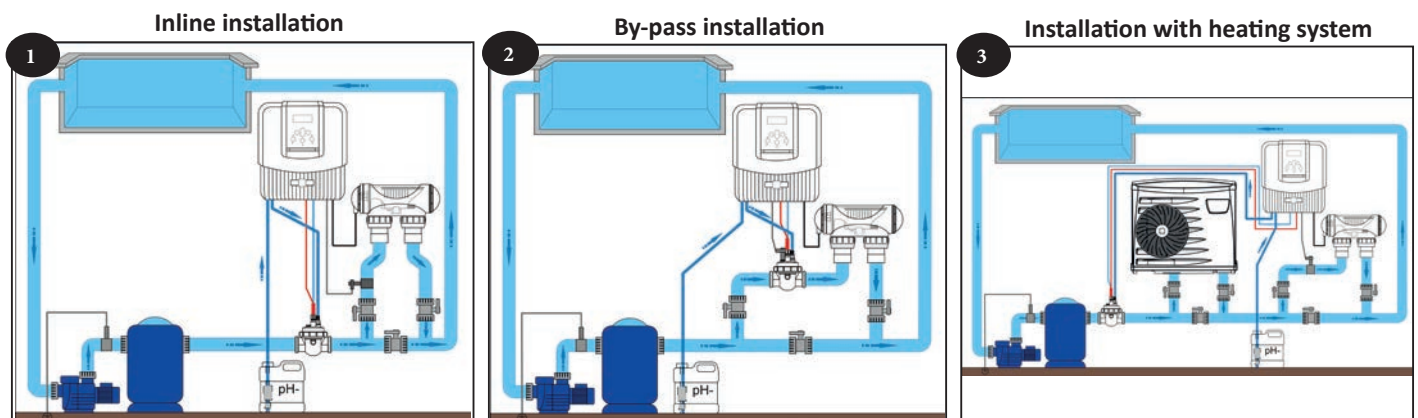

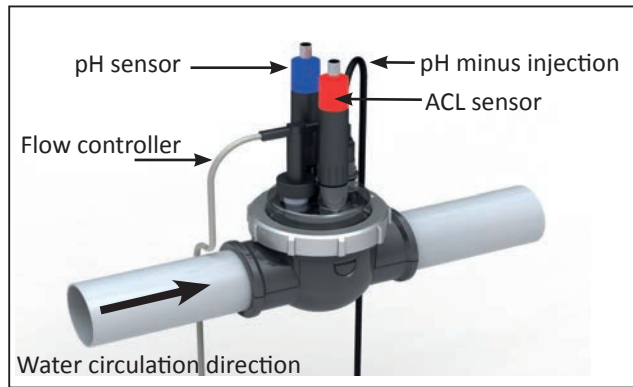

A badly-installed sensor may give false readings and cause inappropriate operation of the appliance. Neither the manufacturer nor the unit shall be liable in this event.

EN

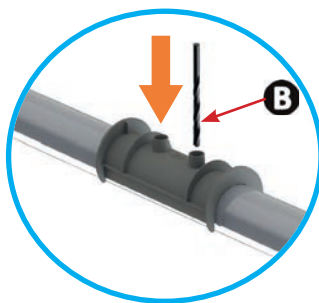
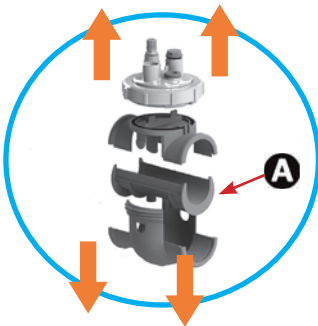

Identify a suitable length (minimum 30 cm, without elbow) of straight pipe.

- Dismantle the POD Kit and keep the EU DN50 mm adapter with 2 holes (A).
- Turn the EU DN50 mm adapter and place it in the position where you want to install it on the pipe.
- Use a center-punch or marker pen to mark the position of the holes to be made in the pipe (B).
- Using the holes saw supplied, cut the 2 feed holes for the POD Kit.



Ensure that the edges of the holes are smooth and deburred!

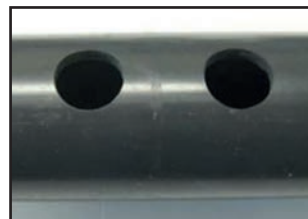

- Place the upper part of the POD Kit on the pipe, sliding it into the previously-drilled holes.



The arrows on the upper part of the POD collar show the direction of water flow.

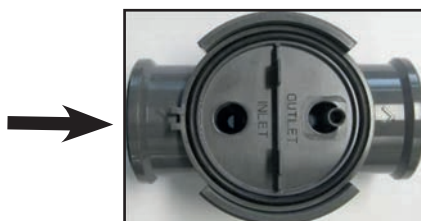

Adapter (labelled "EU") Ø50 mm



Collar Ø63

- Click the 2 parts of the POD Kit collar together around the pipe. For a Ø50 mm pipe, use the adapter labelled 'EU'. Do not use this adapter for a Ø63 mm pipe.
- Position the upper part of the POD Kit with its various components in the direction indicated by the foolproof locating notch, check that the point (C) of the clamping ring and the arrow (D) of the clamp are aligned and tighten the locking ring firmly (hand-tighten only).

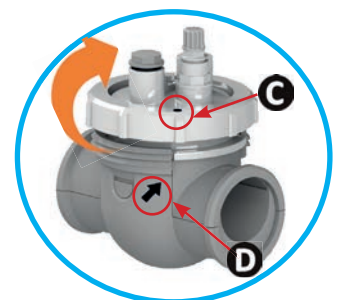

2.3.1 Installing the pH and ACL sensors

- Carefully unscrew the protection cap from the sensor (1).
- For a first installation: rinse the end of the sensor with tap water and shake off excess water.
- For a restart after wintering: clean the sensor, see «4.1 Nettoyage de la/des sonde(s)», then calibrate it before installing it, see «3.3 Calibrage de la/des sonde(s)».

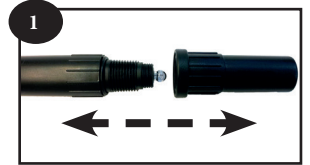

⚠ Never wipe the sensor using a cloth or paper tissue, as this may damage it!

- Screw the sensor into the threaded hole on the POD Kit until the O-ring seal on the sensor comes in contact with the POD kit (2). Do not use excess strength. If necessary, use the supplied Teflon band.
- Connect the supplied BNC cable to the top of the sensor.

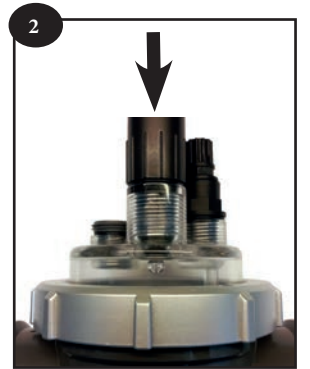

⚠ Do NOT screw/unscrew the sensors while they are still connected to their BNC cables. Disconnect the cables beforehand to avoid damage.

- Once the sensors are installed they may be connected to the BNC sockets on the power pack named "pH" (blue) and "ACL" (red). They must now be calibrated (see "3.3 Calibrating the sensor(s)").

2.3.2 Installing the flow switch

2 positions possible:

- After the upstream valve if the cell is in by-pass (1)
- On the POD kit, if the cell is inline (2)

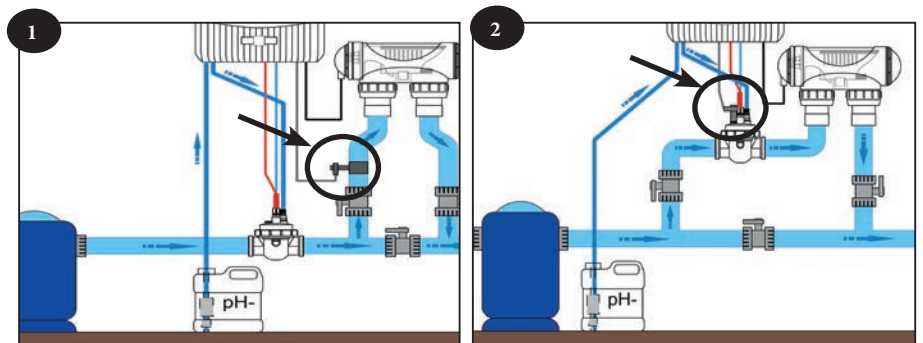

a) pH Link or Dual Link module installed at the same time as the power pack.

- Locate the flow switch supplied with the power pack.
- Place the flow switch into the seat provided on the POD Kit.
- Tighten the flow controller using the tightening nut only (tighten by hand!).

⚠ The arrow that indicates the water flow direction on the top of the flow switch must be perfectly parallel with the pipes on which the POD kit is positioned.

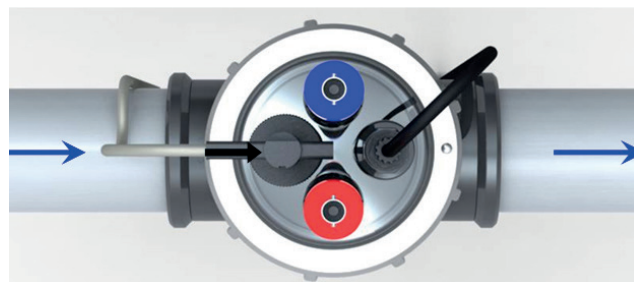

b) pH Link or Dual Link module added to an installation already equipped with a power pack

When the swimming pool already has a power pack, the flow switch is already installed. Leave the flow switch in place. Unscrew the threaded adaptor located on the POD Kit and replace it with the stopped supplied to seal the hole.

2.3.3 Installing the pH minus injection line



When handling chemical products, always use appropriate safety equipment (safety glasses, gloves and jacket).

a) Installing the injection line (peristaltic pump > non-return valve)

- Remove the protective cover from the peristaltic pump,
- Cut a suitable length of pipe from the coil supplied to connect the peristaltic pump to the injection non-return valve located on the POD Kit
- Attach the pipe to the threaded connector on the peristaltic pump outlet.
- Attach the other end of the pipe to the injection non-return valve.

b) Installing the intake pipe (container > peristaltic pump)

- Cut a suitable length of pipe from the coil supplied to connect the container of pH minus to the peristaltic pump.
- Attach the pipe to the threaded connector on the peristaltic pump inlet.
- Make a hole to fit the diameter of the intake pipe in the cap of the pH minus container and another smaller hole to avoid the container distorting as the product is sucked up.
- Pass the free end of the pipe through the hole made in the cap and put the ceramic counterweight and threaded locking nozzle on the end.
- Ensure that ALL connections are correct and watertight before operating the pH Link or Dual Link module.
- Replace the protective cover on the peristaltic pump.

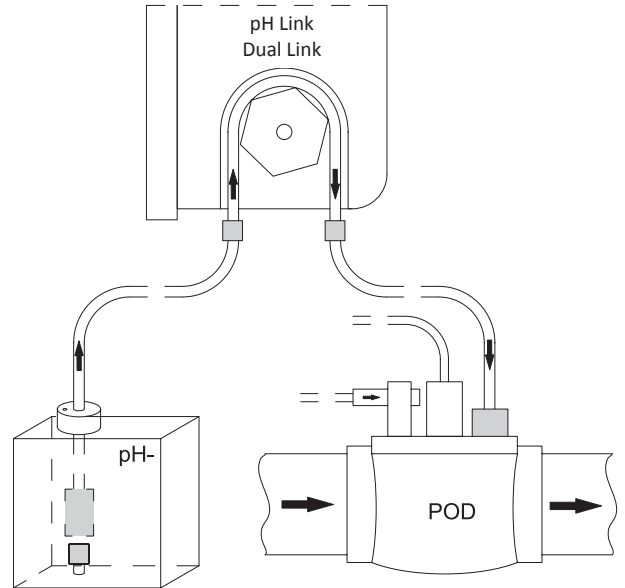

EN

3. Use

3.1 Activating the module

The power pack automatically detects the presence of a pH Link or Dual Link module. It is now ready to be used with automatic pH control using the pH Link module or pH and ACL control using the Dual Link module.

3.2 Display

The LCD screen will display 2 extra lines:

- pH Link module:

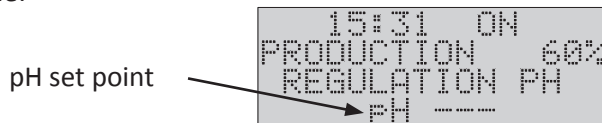

- Dual Link module:

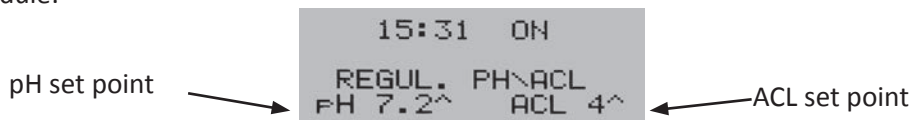

A '^' symbol appears to the right of the set point if the value measured by the equipment needs to be corrected automatically (pH of water in the pool higher than the set point and/or insufficient chlorine level). Then pH minus is injected and/or chlorine produced automatically according to the defined cycles.



By default, pH regulation (peristaltic pump in the module) is disabled and the LCD screen will display 'pH ---'. It is enabled automatically about 8 hours after being turned on. To enable pH regulation immediately and so display the set point on the LCD screen, (see "3.6.2 Activating / deactivating the peristaltic pump").

3.3 Calibrating the sensor(s)



- To operate accurately and reliably, the sensors must be calibrated before using the power pack with the module. To maintain maximum efficiency of the unit, we recommend calibrating at least once every 2 months during the period the swimming pool is being used.

- Ensure the sensors are cleaned before calibration (see «4.1 Cleaning the sensor(s)»).
- Confirm that the power pack is plugged in,
- Stop the pool pump and isolate the sensors by closing any valves, so as to be able to remove the sensors safely.
- Disconnect the BNC cable from the top of each sensor then remove them (unscrew) from the POD. Then reconnect the BNC cable to the sensors.
- Rinse the end of the sensors with clean water and shake them to remove excess water. Do not touch or wipe the glass bulb at the end of the sensors.



- Put the pH sensor into a sample of the pH7.5 buffer solution supplied.
- Put the ACL sensor into a sample of the 700 mV buffer solution supplied.
- Leave the sensors immersed for about 1 minute to obtain a reliable measurement.

- Press or then use the or keys to display "CALIB. PH" or "CALIB. PH\ACL",
- then press or .
- Use the or keys to display "CALIBRAGE PH" (pH Link and Dual Link) or " CALIBRAGE ACL" (Dual Link only) then press or .

Note the measured value:

- pH = 'X.X'
 - If the value is greater than 8.2 or less than 6.4: the sensor is dirty or has been damaged during transport. Clean the pH sensor (see "4.1 Cleaning the sensor(s)") then repeat the above steps. If the problem persists, contact your reseller.
 - If the value is between 6.4 and 8.2, press or to begin calibration. The procedure takes about 15 seconds.

```
CURRENT PH=7.8
SELECT=CALIBRATE
MENU=EXIT
```

```
CALIBRATING
PLEASE WAIT...
```

```
CURRENT PH=7.5
SELECT=CALIBRATE
MENU=EXIT
```

- When calibration is finished, check that the value displayed equals 7.5, otherwise repeat the calibration.

- ACL = 'XXX'

- Start the calibration procedure by pressing or , the procedure lasts about 15 seconds,

```
CURRENT ACL=640
SELECT=CALIBRATE
MENU=EXIT
```

```
CALIBRATING
PLEASE WAIT...
```

```
CURRENT ACL=700
SELECT=CALIBRATE
MENU=EXIT
```

- If the value is 700: calibration is correct,
- If the value is not 700: repeat the calibration steps. If the problem persists, clean the sensor, see "4.1 Cleaning the sensor(s)",

- Press or or wait 30 seconds to exit.















3.4 Adjusting the set point(s)

The set point is displayed continuously on the LCD home screen.

The default setting for the pH set point is pH7.2 (pH Link and Dual Link modules).

The default setting for the ACL set point is 4 (Dual Link module).

This value provides the ideal compromise to achieve optimum efficiency in terms of water disinfection.

- Calibrating the sensors (see "3.3 Calibrating the sensor(s)").
- Press  or  then use the  or  keys to display "CALIB. PH" or "CALIB. PH\ACL", then press  or .
- Use the  or  keys to display 'PH SET POINT' or 'ACL SET POINT', then press  or .
- Use the  or  keys to change the set point value.
- Press  or  or wait 30 seconds to exit.

EN



- The ACL set point displayed does not match the free chlorine concentration in the pool. This is the desired level of 'disinfection potential' in the water.
- The ACL set point required to reach the optimum chlorine level is different in every swimming pool. A period manual measurement of free chlorine level in the pool is therefore necessary to adjust this ACL set point.
- To increase the chlorine production potential: increase the ACL set point.
- To decrease the chlorine production potential: decrease the ACL set point.



Dual Link module only:

We recommend that you check the free chlorine level in the pool a few days after the module is installed to determine if the rate is ideal (0.5 to 2 ppm, see "2.1 Preparing the pool: water balance"). If, after this period, the free chlorine level is unsuitable, the ACL set point must be changed.

















3.5 Setting the pool volume

List of levels with corresponding volumes:

- Level 1: For small pools up to 40 m³
- Level 2: For mid-size pools from 40 to 60 m³ (default level)
- Level 3: For large pools between 60 and 110 m³
- Level 4: For very large pools over 110 m³



- These values are for guidance only; the choice may vary according to the conditions of use.
- When the volume of the pool is at the limit between 2 levels, it is better to use the higher level.
- However, we recommend not 'over-sizing' the choice of level, to avoid using too much pH minus.
- A dose of pH minus is injected into the pool every 2 hours (when the filtration and water treatment systems are running).

- Press  or  then use the  or  keys to display "CALIB. PH" or "CALIB. PH\ACL", then press  or .
- Use the  or  keys to display 'POOL VOLUME', then press  or .
- Use the  or  keys to select the desired level appropriate to the pool size.
- Press  or  to confirm the choice then press  or  or wait 30 seconds to exit.













3.6 Peristaltic pump

3.6.1 Test / priming the peristaltic pump

After installation, we recommend testing the peristaltic pump for the module and priming it (system self-priming).



- Before testing the peristaltic pump, ensure that all pH minus suction and injection pipes are correctly connected.
- Visually check that the peristaltic pipe is not stuck.
- Always use appropriate safety equipment when handling chemical products.

- Switch on the power pack ( button).
- Press  or , then use the  or  keys to display "CALIB. PH" or "CALIB. PH\ACL", then press  or .
- Use the  or  keys to display "TEST DOSAGE".
- A warning will be displayed briefly, then press  or  to confirm starting the pump. The peristaltic pump will operate for about 30 seconds and will stop automatically.
- If the pump must be stopped immediately, press  or .
- Confirm that the pump is primed (pH minus solution will be visible in the translucent pipes).













To prime the peristaltic pump more quickly, it may be necessary to repeat these steps several times, depending on the length of the pH minus feed line.

3.6.2 Activating / deactivating the peristaltic pump

For safety reasons the peristaltic pump is not activated when delivered.

When the pH Link or Dual Link module is connected to the power pack, the peristaltic pump is programmed to start approximately about 8 hours after being turned on. During this period, the default display on the LCD screen will show "pH ---".

To activate the peristaltic pump immediately:

- Press  or , then use the  or  keys to display "CALIB. PH" or "CALIB. PH\ACL" then press  or .
- Use the  or  keys to reach the "DOSAGE OFF" (or "DOSAGE ON" line if the pump had previously been activated).
- Press  or  to activate the peristaltic pump ("DOSAGE ON") or deactivate the peristaltic pump ("DOSAGE OFF").

4. Maintenance

4.1 Cleaning the sensor(s)

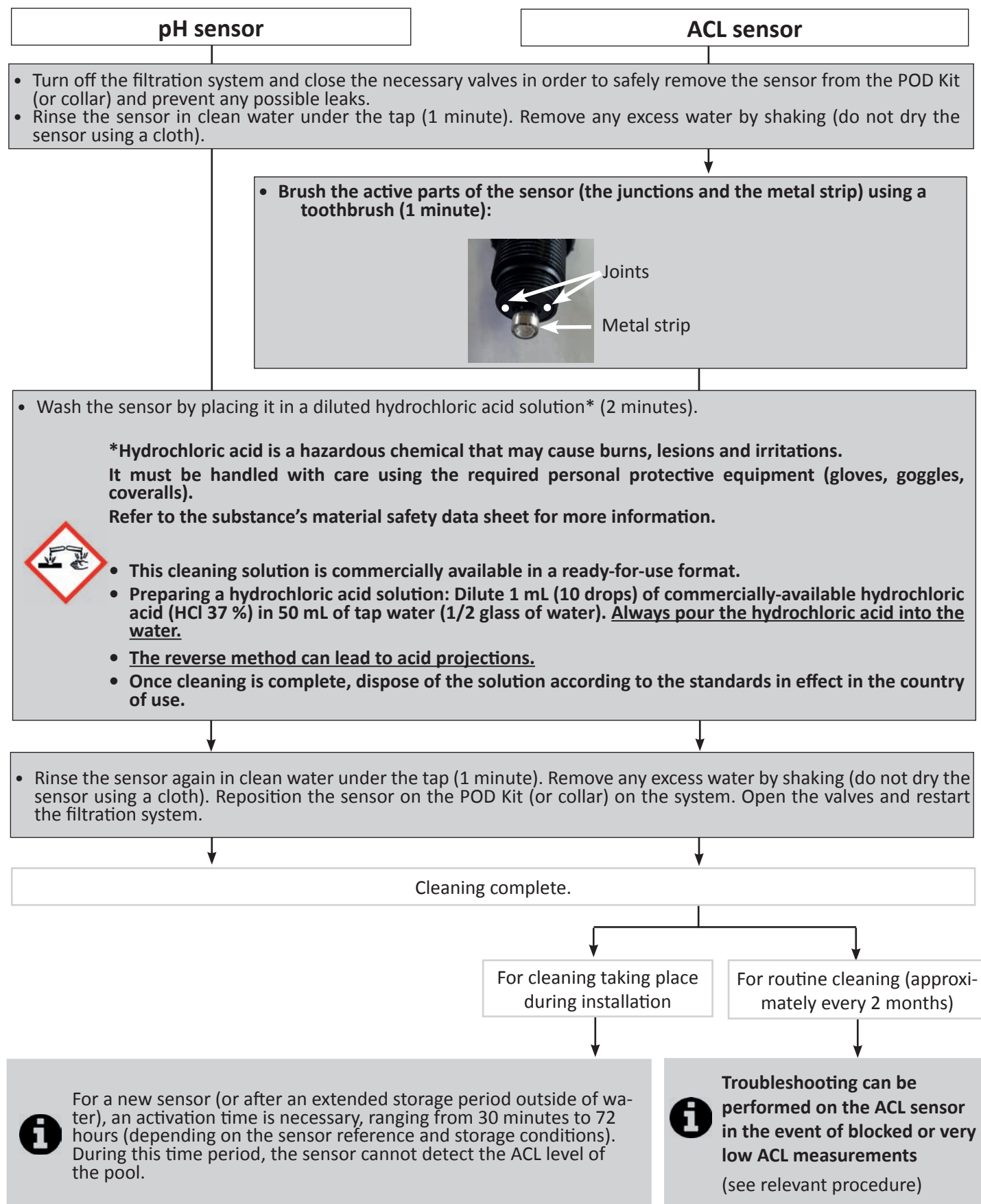

4.2 Winterizing

- Rinse the peristaltic pipe by pumping clean water instead of pH minus solution, using the “TEST DOSAGE” function (see “3.6.1 Test / priming the peristaltic pump”).
- Unscrew the POD sensors (disconnect their BNC cable beforehand). Place them in their original protective caps or in a container filled with tap water.
- If necessary close the POD holes using the threaded stops.



NEVER leave a sensor to dry and/or exposed to the risk of frost, which would permanently damage it.

5. Troubleshooting





- Before you contact your reseller, please carry out these few simple checks using the following table if a problem occurs.
- If the problem continues contact your reseller.
-  : Actions reserved for a qualified technician

Message	Causes	Solutions
PH LOW	The measured 0.8 PH units or more below the set point	Check the pH in the pool
		Check the set point
		Calibrate or replace the pH sensor
	The pH sensor is dirty, out of calibration or not working	Clean and calibrate the sensor
		Replace the pH7.5 buffer solution if necessary
	The pool size setting is too large	Check the selected pool size
PH ERROR	pH adjustment has performed 5 cycles without reaching its set point (> 10 hours)	Check the pH in the pool
		Calibrate or replace the pH sensor
	The pH minus container is empty	Replace the container
	The peristaltic pump is not primed	Test the peristaltic pump
	The pH sensor is dirty, out of calibration or not working	Clean and calibrate the sensor
		Replace the pH7.5 buffer solution if necessary
	The pool size setting is too small	Check the selected pool size
	The peristaltic pump has not been operated for a total of more than 72 hours	The pH in the pool does not need to be corrected
ACL HIGH	The measured Redox potential is more than 150 mV above the set point (the chlorine level may be excessive)	Clean and calibrate the sensors
		Wait until the error message disappears (no chlorine production)
	The pH is too low	Make sure that the stabiliser is lower than 30 ppm
		Reduce the ACL set point
		Make sure that the water's alkalinity level is OK (well and rain water prohibited)
ACL ERROR	The ACL regulation authorised chlorine production for a total of over 30 hours without waiting for the ACL set point	Check the pH in the pool
		Clean and calibrate the sensors
		Replace the buffer solutions if necessary
		Replace the sensors
		Use "Boost" mode if necessary
	The appliance has not produced any chlorine for a total of over 30 hours	Check the pH in the pool
		Clean and calibrate the sensors
		Replace the buffer solutions if necessary
		Replace the sensors

Observation	Causes	Solutions
ACL VERY LOW or ACL BLOCKED	Water balance incorrect	Check the water balance parameters (see «2.1 Preparing the pool: water balance»)
	Excess chlorine stabiliser	Partially drain the pool then top up with fresh water (then check the salt rate).
	The 700 mV buffer solution is no longer effective	Check that the 700 mV buffer solution's manufacturing date is less than 2 years old, and is in good condition.
	The sensor needs cleaning	Clean the sensor (see «4.1 Cleaning the sensor(s)»)

If the problem continues contact your reseller .



To cancel the "PH ERROR" and "ACL ERROR" messages, press  or  for 3 or 4 seconds when the message appears.
The other codes are only information messages that disappear automatically when the operating conditions return to optimal.

EN

6. Product conformity

This appliance is intended to be installed exclusively on the Zodiac® electrolyser or hydroxinator.
This appliance has been designed and manufactured to be in conformity with the applicable requirements of the following standards: EN 60335-1

Relative to which it is compliant. The product has been tested under the normal conditions of use.



Votre revendeur
Your retailer

Modèle appareil
Appliance model

Numéro de série
Serial number

Trouvez plus d'informations et enregistrez votre produit sur
More informations and register you product on

www.zodiac.com

