

Ei²expert

Ei²

GenSalt OE

Instructions for installation and use - English
Salt water chlorinator
Translation of the original instructions in french

EN

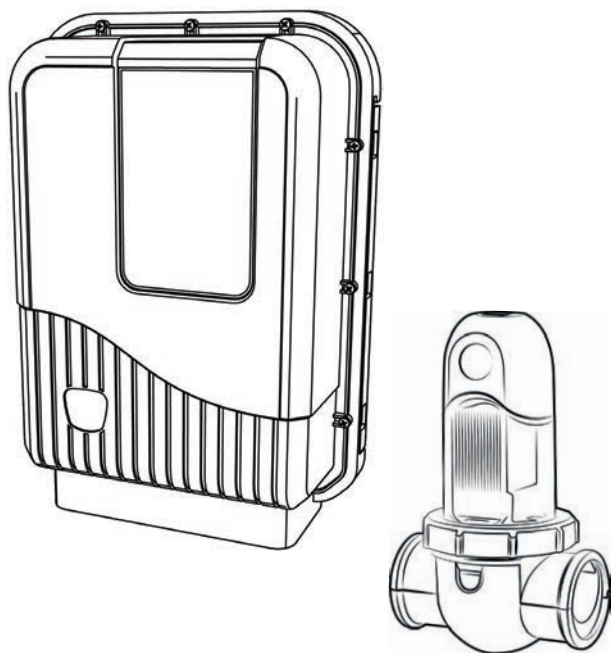

More documents on:
www.zodiac.com

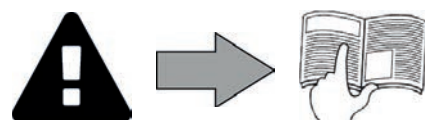

WARNINGS

EN

GENERAL WARNINGS

- Failure to respect the warnings may cause serious damage to the pool equipment or cause serious injury, even death.
- Only a person qualified in the technical fields concerned (electricity, hydraulics or refrigeration) is authorised to perform this procedure. The qualified technician working on the appliance must use/wear personal protective equipment (such as safety goggles and protective gloves, etc.) in order to reduce the risk of injury occurring when working on the appliance.
- Before handling the machine, ensure that it is switched off and isolated.
- The appliance is intended to be used for pools and spas for a specific purpose; it must not be used for any purpose other than that for which it was designed.
- This appliance is not intended for use by persons (including children) with reduced physical, sensory or mental capabilities or lack of experience and knowledge, unless they have been given supervision or instruction concerning use of the appliance by a person responsible for their safety.
- Keep the appliance out of the reach of children.
- The appliance must be installed according to the manufacturer's instructions and in compliance with local standards. The installer is responsible for installing the appliance and for compliance with national installation regulations. Under no circumstances may the manufacturer be held liable in the event of failure to comply with applicable local installation standards.
- For any work other than the simple user maintenance described in this manual, the product should be referred to a qualified professional.
- Incorrect installation and/or use may cause serious damage to property or serious injuries (possibly causing death).
- All equipment, even postage and packing paid, travels at the risks and perils of the recipient. The latter shall issue reserves in writing on the carrier's delivery slip if damage is detected, caused during transport (confirmation to be sent to the carrier within 48 hours by registered letter). In the event that an appliance containing coolant has been turned on its side, mention your reservations in writing to the carrier.
- If the appliance suffers a malfunction, do not try to repair it yourself; instead contact a qualified technician.
- Refer to the warranty conditions for details of the permitted water balance values for operating the appliance.
- Deactivating, eliminating or by-passing any of the safety mechanisms integrated into the appliance shall automatically void the warranty, in addition to the use of spare parts manufactured by unauthorised third-party manufacturers.
- Do not spray insecticide or any other chemical (flammable or non-flammable) in the direction of the appliance, as this may damage the body and cause a fire.
- Zodiac® heat pump, filtration pump and filter appliances are compatible with the most commonly used types of pool water treatment systems.
- Do not touch the fan or moving parts and do not place any objects or your fingers in the vicinity of the moving parts during operation of the appliance. Moving parts can cause serious injury or even death.



WARNINGS ASSOCIATED WITH ELECTRICAL APPLIANCES

- The electrical supply to the appliance must be protected by a dedicated 30 mA differential residual current protection device, complying with the standards and regulations in force in the country in which it is installed.
- Do not use any extension lead when connecting the appliance; connect the appliance directly to a suitable power supply circuit.
- Before carrying out any operations, check that:
 - The voltage indicated on the appliance information plate corresponds to the mains voltage.
 - The power grid is adapted to the power requirements of the appliance, and is grounded.
 - The plug (where applicable) is suitable for the socket.
- In the event of abnormal operation or the release of unusual odours from the appliance, turn it off immediately, unplug it from its power supply and contact a professional.
- Before any access to the appliance for service or maintenance, ensure that it is switched off and completely disconnected from the power supply. Furthermore, in addition to confirming that the heating priority (where applicable) is deactivated, ensure that any other equipment or accessories connected to the appliance are also disconnected from the power supply circuit.
- Do not disconnect and reconnect the appliance to the power supply when in operation.
- Do not pull on the power cord to disconnect it from the power supply.
- If the power cord is damaged, it must be replaced by the manufacturer, its technician or a qualified person to guarantee safety.
- Do not perform maintenance or servicing operations on the appliance with wet hands or if the appliance is wet.
- Before connecting the appliance to the source of supply, ensure that the terminal block or supply socket to which the appliance will be connected is in good condition and is not damaged or corroded in any way.
- For any component or sub-assembly containing a battery: do not recharge or dismantle the battery, or throw it into a fire. Do not expose it to high temperatures or direct sunlight.
- In stormy weather, disconnect the appliance from the power supply to prevent it from suffering lightning damage.
- Do not immerse the appliance in water (with the exception of cleaners) or mud.

Recycling



This symbol means that your appliance must not be thrown into a normal bin. It will be selectively collected for the purpose of reuse, recycling or transformation. Any substances it may contain which are potentially dangerous to the environment shall be eliminated or neutralised.

Request information on recycling procedures from your retailer.



- Before you do anything with the device, it is vital that you read this installation and user manual, as well as the "warnings and warranty" booklet delivered with the device. Failure to do so may result in material damage or serious or fatal injury and will invalidate the warranty.
- Save these instructions for future reference for service and maintenance.
- It is prohibited to distribute or modify this document in any way without authorisation from Zodiac®.
- Zodiac® is constantly developing its products to improve their quality; therefore, the information contained in this document may be modified without notice.



Contents

1. Information before installation	3
1.1 Contents.....	3
1.2 Technical specifications.....	3
2. Installation.....	4
2.1 Preparing the pool: water balance	4
2.2 Installing the control box	4
2.3 Installing the cell.....	5
2.4 Installing the flow controller (Ei ² Expert only)	6
2.5 Electric connections.....	6
3. Use	7
3.1 Description of the Ei ² - GenSalt OE user interface	7
3.2 Description of the Ei ² Expert user interface.....	8
4. Maintenance.....	12
4.1 Washing the pool filter (backwash)	12
4.2 Cleaning the electrode.....	12
4.3 Winterizing.....	12
5. Troubleshooting.....	13
6. Product conformity.....	14

1. Information before installation

1.1 Contents

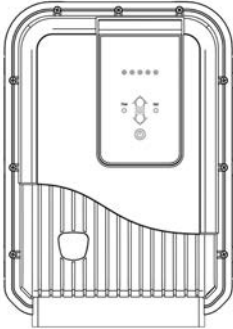
Ei² - GenSalt OE

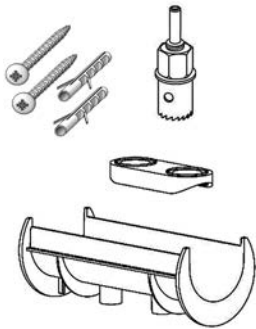
		
Control box	Cell	Installation kit

EN

Ei² Expert

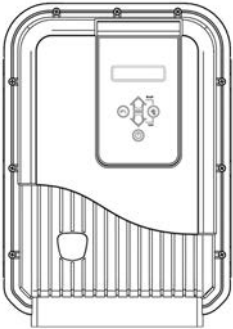
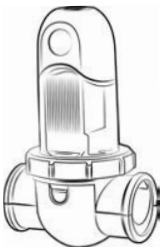
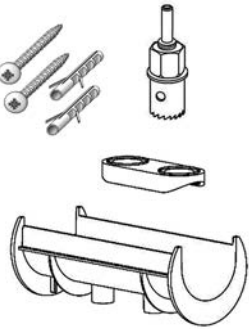
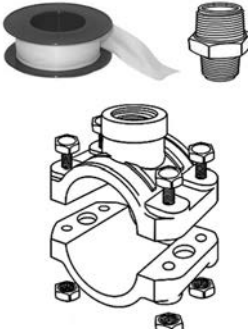
			
Control box	Cell	Installation kit	Fixture collar kit

1.2 Technical specifications

Power supply voltage	230 Vac-50 Hz	
Electric power	Max. 140 W	
Protection index	IPX5	
Box size (l x h x d)	28.5 x 40.5 x 12.5 cm	
Cell size (l x h x d)	16.5 x 22.5 x 12.5 cm	
Weight (box + cell)	6.0 kg (+/- 500 g depending on model)	
	Minimum	Maximum
Flow through the cell	5 m ³ /h	18 m ³ /h - ND 50 mm 25 m ³ /h - ND 63 mm
Pressure in the cell	/	2.75 bar
Operating water temperature	5 °C	40 °C

2. Installation

2.1 Preparing the pool: water balance

These appliances are designed to disinfect pool water using its salt water chlorination function.

It is essential that the pool water balance and salinity are controlled and adjusted before the appliance is installed. Making sure that those parameters are correct from the very start will reduce the likelihood of encountering problems on the first days of operation or during the season the pool is in use.



Even though it is an autonomous system, it is essential to regularly analyse the water to check the water balance parameters and adjust them if necessary.

	Unit	Recommended values	To increase	To decrease	Test frequency (during season)
pH	/	7.2 – 7.4	Add pH+ or use automatic regulation	Add pH- or use automatic regulation	Weekly
Free chlorine	mg/L or ppm	0.5 – 2	Increase the chlorine production or use Boost mode (Ei ² Expert only)	Reduce chlorine production	Weekly
TAC (alkalinity or buffering power)	°f (ppm)	8 – 15 (80 – 150)	Add alkaline corrector (Alca+ or TAC+)	Add hydrochloric acid	Monthly
HL (level of calcium carbonate)	°f (ppm)	10 – 30 (100 – 300)	Add calcium chloride	Add a calcium carbonate sequestering agent (Calci-) or carry out carbonate removal	Monthly
Cyanuric acid (stabiliser)	mg/L or ppm	< 30	Only add cyanuric acid if necessary (Chlor Stab)	Partially empty the pool and refill it	Quarterly
Salinity	g/L or kg/m ³	4	Add salt	Leave as such or partially empty the pool and refill it	Quarterly
Metals (Cu, Fe, Mn...)	mg/L or ppm	± 0	/	Add metal binder (Metal Free)	Quarterly

2.2 Installing the control box

- The control box must be installed in a dry ventilated equipment room protected against frost, with no pool maintenance products stored nearby.
- The control box must be installed a minimum of 2.0m from the surrounding edge of the pool. Any additional local installation codes in the installation country must also be adhered to.
- It must not be installed more than 1.5 metres from the cell (maximum cable length).
- If the box is fixed to a post, a watertight panel must be fixed behind the control box (350x400 mm minimum).
- Fix the support solidly to the wall or the watertight panel, and place the control box on it using the screws provided.

2.3 Installing the cell

- The cell must be installed on the piping after the filtering (A), after any measurement sensors, and after eventual heating systems.

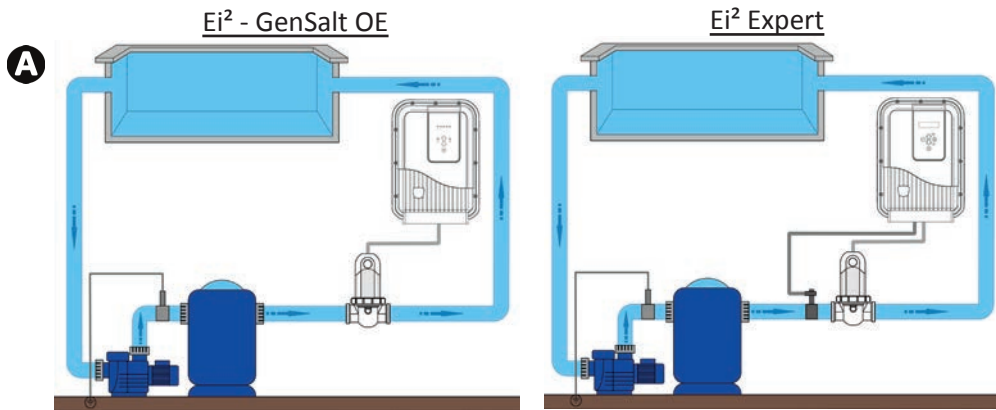

- The cell must be installed on a horizontal pipe to ensure an essentially horizontal flow of water through it, with no more than a 30 deg angle/slope. The pipe must have a free horizontal length of at least 30cm on which the cell will be installed. The cell must also be installed as far away as possible from any bends or elbows in the plumbing (B).
- Ensure that the direction of flow of water through the cell is in accordance with the arrows marked on the cell (see arrows (C)).

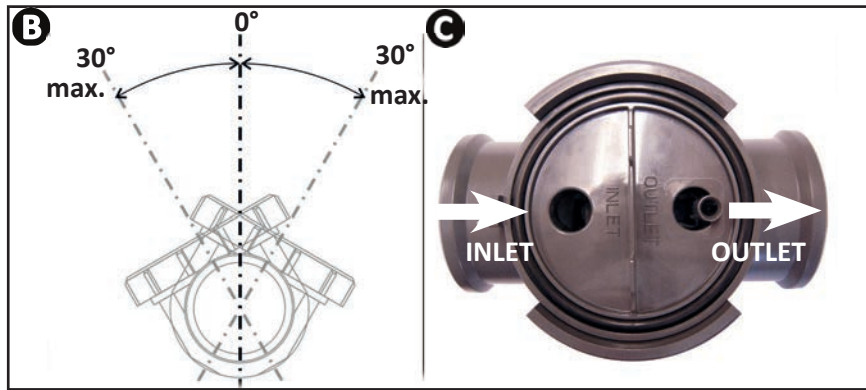

- Dismantle the cell (D).
- Position EU (DN50 mm) hole adapter upside down at the position where the pipe will be installed (E).
- Use a drill bit or centre-punch to mark the positions of the holes to be drilled on the pipe, remove EU (DN50 mm) hole adapter, and drill the holes using the hole saw supplied.
- Check that the edges are perfectly smooth and deburred (use abrasive paper, for example).
- Clip together the lower and upper parts of the cell collar on the pipe at the holes, respecting the water flow direction (use the "EU" Ø50 reducer for a Ø50 mm pipe).
- Position the top transparent part of the cell (presence of a foolproof locating notch), position the locking ring on the thread of the upper collar by aligning the point (F) of the collar with the arrow of the collar (G), then tighten firmly by hand (do not use a tool).

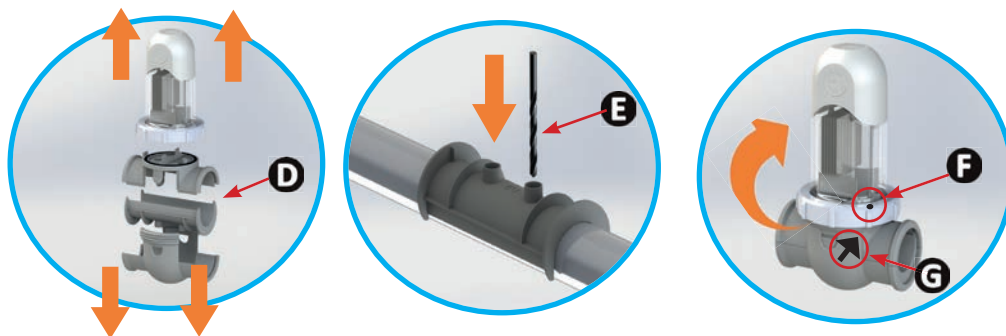

- Connect the cell power supply cable in compliance with the wire colour codes (red, black and blue connectors) and then fit the protective cap.
- Pour les modèles Ei² 12, GenSalt OE 10 ou Ei² Expert 10, le deuxième connecteur rouge ne sera pas branché ; le laisser tel quel avant de mettre le cache de protection.



- The cell must always be the last element placed on the pool return pipe (see diagram).
- It is always recommended to install the cell on a by-pass. This assembly is **MANDATORY** if the flow is in excess of 18 m³/hour to avoid load loss.
- If you installed the cell on a by-pass, it is recommended to fit a check valve downstream from the cell instead of a manual valve, to avoid the risk of an improper setting which could result in the incorrect flow water back into the cell.
- Failure to locate and orient the cell in strict accordance with these instructions can result in a hazardous buildup of pressurized gas which can result in serious property damage and serious injury, including loss of life.



An "AUS" reducer and a black seal are supplied in the installation kit. They are intended for 1 1/2" (= 38 mm) pipes. However, the black seal can be used instead of the original seal if the pipe is not standardised (diameter smaller than ND 50 or ND 63).

2.4 Installing the flow controller (Ei² Expert only)

The flow controller and its fixture collar (Ø50 mm) must imperatively be installed on the piping close to the cell and upstream from it. Use the threaded adapter and Teflon tape supplied to install the flow controller on its fixture collar.

- Cell installed in by-pass: the flow controller must be installed on the cell by-pass between the upstream isolation valve and the cell itself.
- Cell installed in line: the flow controller must be installed just in front of the cell and after a possible valve.
- Fixer le contrôleur de débit en utilisant uniquement l'écrou de serrage.

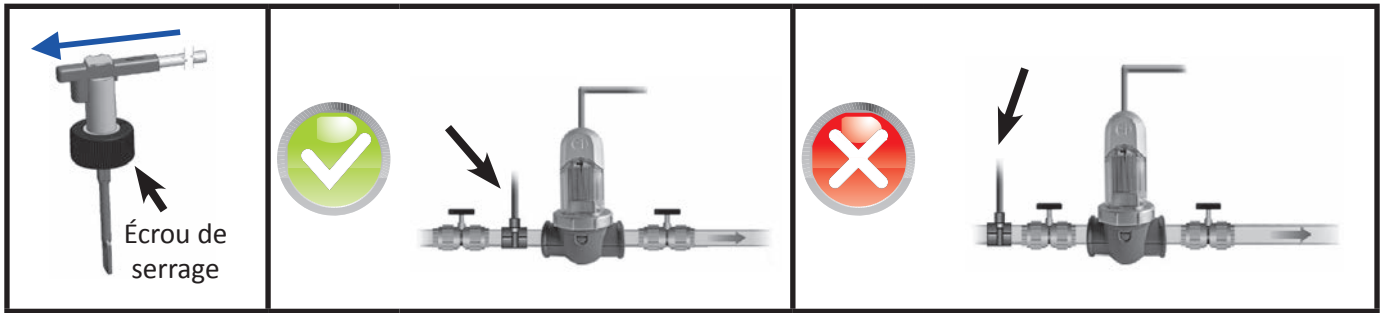

- Failure to comply with these instructions could lead to the destruction of the cell! The manufacturer cannot be held liable in this case.
- The flow detector has a direction for installation (arrow indicated on it showing the flow direction for the water). Make sure that it is correctly placed on its fixture collar so that it stops the salt water chlorinator production when filtering is stopped ("No flow" displayed showing the absence of flow, see "5. Troubleshooting").

2.5 Electric connections

2.5.1 Connecting the control box

The salt water chlorinator can be connected in compliance with the applicable standards in the country of installation.

Ei² - GenSalt OE :

- Mandatory connection: directly interlocked with the pool filtration pump (the appliance is only supplied with power when the pool filtration pump is operating).

Ei² Expert:

- Preferred connection: the appliance is permanently connected (hard-wired) to the power supply (power supply protected by a 30 mA ground fault circuit breaker).
- Possible connection: directly coupled to the pool filtering (the appliance is only supplied with power when filtering is operating).

==> When all connections (electrical and hydraulic) have been made, reconnect (turn on) the mains power supply to power on the appliance.



- Failure to comply with these instructions could lead to the destruction of the cell! The manufacturer cannot be held liable in this case.
- Whichever connection is used, it is mandatory to programme the Ei² Expert operating times (called "Timers") (see "3.2.5 "Summer" and "Winter" modes and setting the "Timers"").

2.5.2 Connection to an electric pool cover (Ei² Expert only)

If the pool is fitted with an electric roll-on electric pool cover, it can be connected to the Ei² Expert chlorinator using a dry contact so that the latter automatically adapts its chlorine production when the electric pool cover is closed (see "").

- Make sure the appliance is powered off and disconnected (e.g., by turning off the circuit breaker or disconnect switch) from the mains source of power.
- Remove the 12 screws securing the cover screws and remove it (take care not to tear out the ribbon cables).
- Unscrew the dedicated cable gland tightening ring (at the bottom of the control box) and remove the plug to feed through the cable from the electric pool cover. Tighten the cable gland tightening ring.
- Connect the cable from the electric pool cover on the "POOL+" and "POOL-" connectors on the electronic board.
- Close the box by following the tightening order shown on the following diagram (9 long screws for the perimeter of the box and 3 short screws for the bottom of the box). The IPX5 water ingress protection (IP) rating of the box may be compromised if this procedure is not properly followed.

EN

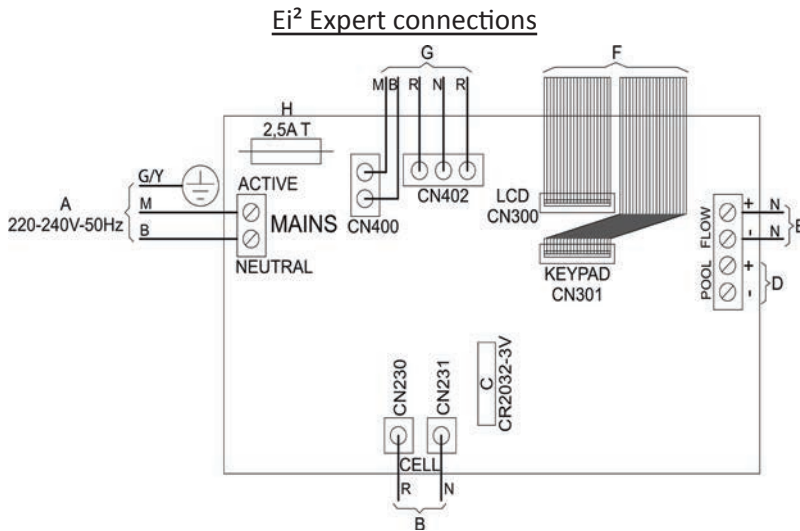

Torque = 1.2 N.m (= 12.2 kg.cm)

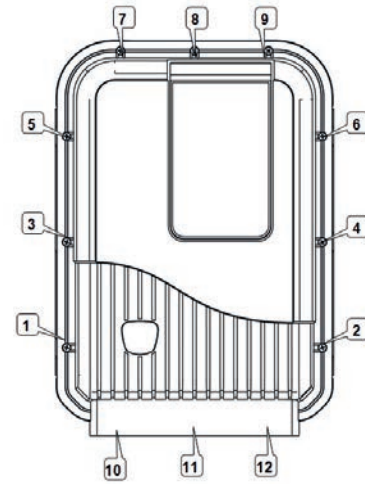

		Ei ² GenSalt OE	Ei ² Expert		Ei ² GenSalt OE	Ei ² Expert
A	Mains power supply 220-240 Vac / 50 Hz	X	X	E	Connection of flow detector	X
B	Cell power supply	X	X	F	Ribbon cables at the user interface	X (1) X (2)
C	Memory battery type CR2032	X	X	G	Transformer connections	X X
D	Cover connection (contact closed = cover closed)		X	H	Fuse 2.5 A time-delayed	X X

- The Ei² Expert chlorinator is compatible with several different types of electric pool cover. However, certain systems may not be compatible. In this case, activate "Low" mode manually from the chlorinator control panel (see "").
- Refer to the electric pool cover manufacturer's installation manual.
- The dry contact operating principle is as follows: contact closed = electric pool cover closed.

3. Use

3.1 Description of the Ei² - GenSalt OE user interface

		Increase or reduction the chlorine production:
		- Activate / deactivate the chlorine production by a short press. - Switch off the device with a long press (5 seconds). - Switch on the device with a short press.
	FLOW	Red indicator showing the absence of flow and/or presence of air in the cell.
	SALT	Orange indicator showing a water conductivity problem (not enough salt, water too cold, etc.).

3.2 Description of the Ei² Expert user interface

		<ul style="list-style-type: none"> - Exit the user menu or the internal settings menu. - Deactivate Boost mode or Low mode.
		<ul style="list-style-type: none"> - From the home screen: increase or decrease in chlorine production. - In the user menu: value changes when a choice is proposed (flashing characters). - Simultaneous press for 5 seconds: access the internal settings menu.
		<ul style="list-style-type: none"> - Access to user menu and navigation in the settings (with successive presses)
		<ul style="list-style-type: none"> - Activate/deactivate the chlorine production by a short press. - Switch off the device with a long press - Switch on the device with a short press
		<ul style="list-style-type: none"> - Activate Boost mode
		<ul style="list-style-type: none"> - Activate "Low" mode manually

i If the language displayed on the screen when the Ei² Expert is first switched on is not appropriate, see "3.2.6 "Internal settings" menu".

3.2.1 Chlorine production activated

When chlorine production starts, the "Start..." message is displayed on screen for about 6 seconds. "CHLORINATION" is then displayed, indicating that the device is producing chlorine.

3.2.2 "Boost" mode: chlorine production increased to 100 % for 24 h

In certain cases the pool may need higher than normal chlorination (stormy weather, high number of bathers, etc.). "Boost" mode is used to increase chlorine level quickly.

- Press buttons and simultaneously: "BOOST" is displayed on the screen and 100 % chlorine production starts.
- To stop "Boost" mode, press .

i When "Boost" mode is activated, the rated chlorine production settings are temporarily overridden and the Ei² Expert chlorinator will operate for a total of 24 hours at 100 % chlorine production. The number of days will therefore depend on the Ei² Expert operating times (see "3.2.5 "Summer" and "Winter" modes and setting the "Timers").

3.2.3 "Low" mode: chlorine production reduced to 10 % if the pool is covered

If the pool has a covering system (shelter, electric pool cover, etc.), "Low" mode is designed to adapt the chlorine production to situations where the pool is covered (lower needs). Its effect is to limit chlorine production to 10%. This mode is also called "electric pool cover" mode.

Manual activation (shelter, cover, etc.) :

- Press buttons and simultaneously: "LOW" is displayed on the screen and chlorine production is reduced to 10 %.
- To stop "Low" mode, press .

Automatic activation (compatible electric pool cover):

- Make sure that the electric pool cover is compatible and connected to the Ei² Expert chlorinator (see "").
- «Low» mode will automatically be activated when the electric pool cover is closed.
- "Low" mode will stop as soon as the electric pool cover is completely open.

3.2.4 Setting the time



The Ei² Expert chlorinator is fitted with an internal memory. When the device is first switched on it is important to leave it powered on continuously for at least 24 hours in order to initially charge the accumulator (permanent separate power supply or filtering on permanently). Once charged the accumulator has several weeks of autonomy in the event of a power failure. The time is displayed in a 24 hour format.

- Switch on the device and wait until screen start-up sequence is finished.
- Press the button to access the user menu, the minutes start to flash.
- Use the and buttons to set the minutes, then press to store.
- Use the and buttons to set the hours, then press to store.
- Press the button to return to the home screen.

EN

3.2.5 "Summer" and "Winter" modes and setting the "Timers"



"Timer" programming is used to define the device operating times within the filtering system operation times. The daily operating times must be sufficient to correctly treat the water. Ei² Expert proposes default settings of Timers 1 and 2. They can be customised (see "3.2.5.b Programming the timers according to the modes"). A reminder of the calculation rule: the ideal daily filtering time is obtained by dividing the required pool water temperature (measured in °C) by 2. Example: for water at 28 °C, time = 28/2 = 14 hours per day



The Ei² Expert chlorinator can store 2 seasonal operating modes called by default "Sum" and "Win". The following settings can be customised for each mode:

- the device operating times, the "timers": T1 (Timer 1) and T2 (Timer 2)
- the required chlorine production rate: 10 %, 20 %, 30 %, ... up to 100 %.

S T A N D B Y
T S M R 8 0 % 1 4 : 2 5

STANDBY = Device operating status





T = "Timer" mode (always active)

SUM = "Summer" operating mode

80 % = chlorine production rate

14:25 = time in 24 h format

3.2.5.a Mode selection: "SUMMER" or "WINTER"

- Press  4 times to set the clock. "SUM" starts to flash.
- Use the  and  buttons to choose "SUM" or "WIN" mode, then press the  button to return the home screen.



















3.2.5.b Programming the timers according to the modes

 The times of Timers 1 and 2 cannot overlap. In addition, the time range of Timer 1 necessarily precedes that of Timer 2.

```

T E 1  0 8 : 0 0 - 1 2 : 0 0
T E 2  1 4 : 0 0 - 1 8 : 0 0
    
```

TE1 / TE2 = Timer in "summer" mode No. 1 / Timer in "summer" mode No. 2
08:00-12:00 = Operating time range of Timer No. 1
14:00-18:00 = Operating time range of Timer No. 2

- Press  4 times to set the clock. "SUM" starts to flash.
- Select the mode to be customised "SUM" or "WIN" using the  and  buttons, then press  to store and move to the timer setting screen.
- Use the  and  buttons to set the Timer 1 stop minutes, then press  to store.
- Use the  and  buttons to set the Timer 1 stop hours, then press  to store.
- Use the  and  buttons to set the Timer 1 start minutes, then press  to store.
- Use the  and  buttons to set the Timer 1 start hours, then press  to store.
- Repeat the steps for Timer 2.
- Press the  button to store the timers and move to setting the chlorine production rate.
- Use the  and  buttons to choose the required chlorine production rate (from 10 % to 100 %).

3.2.6 "Internal settings" menu

Ei² Expert has an "Internal settings" menu to change and/or view the following operating parameters:

- Language
- Polarity inversion cycles
- Operating hours counter

To access this menu, press the  and  buttons simultaneously for 5 seconds.

```

E M E A  E N  E n g l i s h
C y c = 5 h      0 0 0 0
    
```

EMEA: Device sale and use region (not modifiable)





FR French: Language used (modifiable, by default = French)

Cyc=5h: Polarity inversion cycle (modifiable, by default = 5 h)

00000: Operating hours counter (not modifiable)

3.2.6.a Setting the language

 By default the Ei² Expert chlorinator is set to display in French. 13 languages are available: French, English, Spanish, Italian, Swedish, German, Portuguese, Dutch, Afrikaans, Czech, Hungarian, Slovakian and Turkish.

- From the home screen, press the  and  buttons for 5 seconds. The current language starts to flash.
- Use the  and  buttons to select the required language.
- Press the  button to return to the home screen.







EN

3.2.6.b Polarity inversion

 **The choice of polarity inversion cycles may affect the cell lifetime (+/- 15 %). Ask your professional reseller for advice in case of doubt.**



The electrolytic cell is equipped with a smart polarity inversion system designed to prevent the electrode plates from scaling. However cleaning may be required in regions where the water is very hard. (default setting = 5 hours).

-  Ei² Expert offers a choice of 3 inversion cycles:
- **3 hours:** for water of high carbonate content (TH > 40 °f or 400 ppm)
 - **5 hours:** for normal water (20 °f < TH < 40 °f or 200 ppm < TH < 400 ppm)
 - **7 hours:** for water of low carbonate content (TH < 20 °f or 200 ppm).

- From the home screen, press the  and  buttons for 5 seconds.
- Press the  button. The polarity inversion cycle hours start to flash.
- Use the  and  buttons to select the required cycle.
- Press the  button to return to the home screen.

3.2.6.c Operating hours counter

 Ei² Expert can count its total operating hours (= chlorine production time, affiché en jours). This information may be useful to determine the electrode age. The value is provided for information only and may be modified.

- From the home screen, press the  and  buttons for 5 seconds.
- The number of operating hours is displayed at the bottom right of the screen.
- Press the  button to return to the home screen.

4. Maintenance

4.1 Washing the pool filter (backwash)

L'appareil doit impérativement être éteint lors des procédures de lavage de filtre. When the device is on (filtration on), press the  button for 5 seconds to switch it off.



After cleaning the filter, switch the device on again by pressing the  button (short press). It will resume normal operation (production slaved to filtration for Ei² and GenSalt OE).

Pour Ei² Expert la production fonctionnera selon le réglage des timers.

The manufacturer cannot be held liable in case of incorrect handling.

4.2 Cleaning the electrode



The electrolyser is equipped with a smart polarity inversion system designed to prevent the electrode plates from scaling. However cleaning may be required in regions where the water is very hard. (default setting = 5 hours).

- Turn off the chlorinator and the filtering, close the isolation valves, remove the protection cover and disconnect the cell power cable.
- Unscrew the tightening ring and remove the cell. The ring is notched thus allowing a lever to be used in the event of it jamming. Place the cell backwards and fill it with a cleaning solution so that the electrode plates are immersed.
- Leave the cleaning solution to dissolve the scale deposit for about 15 minutes. Dispose of the cleaning solution at an approved waste recycling site, never pour into the rainwater drainage system or into the sewers.
- Rinse the electrode using clean water and put it back on the cell fixture collar (there is an alignment foolproof).
- Refit the tightening ring, reconnect the cell cable and refit the protective cover. Open the isolation valves and restart the filtering and chlorinator.



• If you do not use a commercially available cleaning solution, you can manufacture it yourself by carefully mixing 1 volume of hydrochloric acid with 9 volumes of water (Warning: always pour the acid into the water and not the opposite and wear suitable protective equipment!).

• Make sure that the setting of the polarity inversion cycles is adapted to the pool water hardness. See "3.2.6.b Polarity inversion" to change them.

4.3 Winterizing



The chlorinator has a protective system to limit chlorine production under poor operating conditions such as cold water (winter) or a lack of salt.

- Active winterizing = filtering operational in winter: below 10 °C it is preferable to switch off the chlorinator. Above this temperature you can leave it running.
- Passive winterizing = lower water level and drained piping: leave the electrode dry in its cell with its isolation valves open.

5. Troubleshooting

Ei ² GenSalt OE	Ei ² Expert	Possible causes	Solutions
	INVERSION	The self-cleaning cycle is automatic; this message is not an error code but an information message.	<ul style="list-style-type: none"> • Wait for about 10 minutes and chlorine production will resume automatically at the previously set level.
/	HIGH SALT	<ul style="list-style-type: none"> • Salt overload (> 10 g/L). 	<ul style="list-style-type: none"> • Drain the pool partially to reduce the salt concentration.
"Salt" indicator on	CHECK SALT	<ul style="list-style-type: none"> • Lack of salt (< 3g/L) due to water loss or dilution (filter backwash, water renewal, rain, leaks, etc.). • Pool water temperature too low (< 18 °C, variable). • Cell scaled up or worn. 	<ul style="list-style-type: none"> • Add salt to the pool to keep the level at 4 g/l. If you do not know the salt level or how to test it, consult your reseller. • Basic production limitation signal when the water is too cold. Reduce chlorine production or add salt to compensate. • Clean or replace the cell.
"Flow" indicator on	NO FLOW	<ul style="list-style-type: none"> • Stop or failure of the filtering pump. • Presence of air or gas in the cell (incorrect filling with water). • By-pass valves closed. • Flow controller and/or cell disconnected or defective. 	<ul style="list-style-type: none"> • Check the pump and its programming clock, the filter, the skimmer(s), and the by-pass valves. Clean them if necessary. • Check the cable connections (cell and flow controller). • Check that the flow controller is working correctly (replace it if necessary).
/	PUMP CONTROLLER	<ul style="list-style-type: none"> • This message is displayed alternately with "NO FLOW" if the situation continues. 	<ul style="list-style-type: none"> • Perform the same checks as above.
/	OUTPUT FAULT	<ul style="list-style-type: none"> • Short-circuit in the cell or cable disconnected/badly connected. • Worn electrode. • Important manque de sel, ou pas de sel. • Sel non encore suffisamment dilué. 	<ul style="list-style-type: none"> • Check the cell connections. • Replace the cell. • Have the control box (electronic board and transformer) checked by a qualified technician if necessary. • Ajouter du sel dans la piscine pour maintenir un niveau à 4 g/L.
/	OVERHEATING	<ul style="list-style-type: none"> • Device internal temperature over 70 °C. • Device internal temperature over 80 °C. 	<ul style="list-style-type: none"> • The device reduces its production to 50 %. • Production stops. • Production restarts automatically when the temperature drops.
/	All the settings are lost	<ul style="list-style-type: none"> • The appliance no longer saves the settings (production level, power, time, language, timers, etc.) 	<ul style="list-style-type: none"> • Check the accumulator. • Replace if necessary ("CR2032"-type 3 V accumulator), see "2.5.2 Connection to an electric pool cover (Ei2 Expert only)" to open and close the box. • Reprogramme the appliance's different settings, see "3.2.4 Setting the time", "3.2.5 "Summer" and "Winter" modes and setting the "Timers"", and "3.2.6 "Internal settings" menu".

==> If the problem continues contact your reseller 

EN

6. Product conformity

This appliance has been designed and manufactured to comply with the applicable requirements of the following standards :

EN6000-6-1: 2006

EN6000-6-3: 2007

IEC 60335-1

Relative to which it is compliant. The product has been tested under the intended normal conditions of use.



Votre revendeur
Your retailer

Modèle appareil
Appliance model

Numéro de série
Serial number

Trouvez plus d'informations et enregistrez votre produit sur
More informations and register you product on

www.zodiac.com

