

# SIROCCO

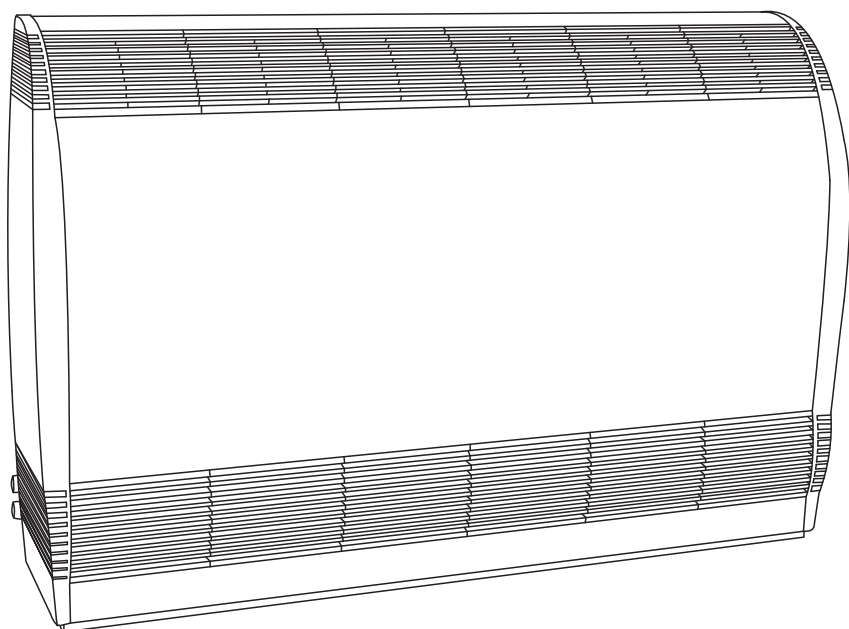

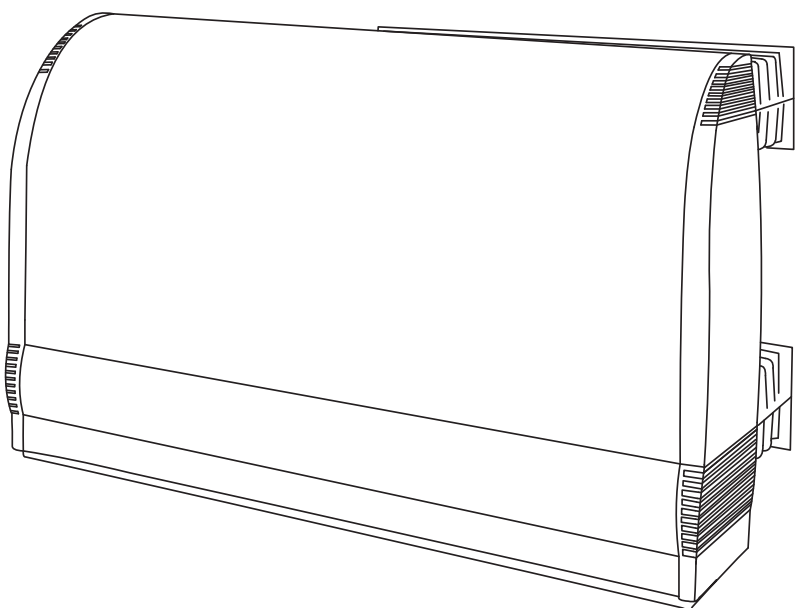

Instructions for installation and use  
English

**EN**

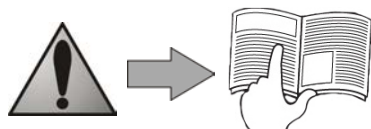
More languages on:  
[www.zodiac-poolcare.com](http://www.zodiac-poolcare.com)



- Read this manual carefully before installing, maintaining or repairing this device!
- The symbol  indicates important information that must be taken into account in order to avoid risk of personal injury and/or damage to the appliance.
- The symbol  indicates useful information.



## Warnings



- Our products may be subject to change without notice as part of our continuous improvement policy.
- Exclusive use: for dehumidifying swimming pool premises (must not be used for any other purpose),
- This device must be installed and serviced by certified professionals approved in the electrical, hydraulic and cooling domains,
- It must be installed in premises that are closed and well aired; in an area that is: not exposed to freezing risk, out of reach of water splashes, and where no pool maintenance products are stored, the installation in outside involves the suppression of the guarantee,
- The device must be installed by a qualified technician according to the manufacturer's instructions and in compliance with local regulations. The installer is responsible for the correct installation of the device and for ensuring compliance with local regulations. The manufacturer shall not be held liable for any potential issues that may occur as a result of failure to comply with local standards pertaining to installation,
- Incorrect installation may cause serious damage and/or personal injuries (possibly death),
- This appliance must be handled by competent and qualified personnel (physically and mentally) who are familiar with the operating instructions (by reading the user guide). Persons who do not satisfy these requirements must not handle the device so as to avoid exposure to potentially dangerous parts.
- If the device malfunctions: do not attempt to repair the device yourself, call your retailer,
- Before carrying out any operation on the machine, check that the power supply is cut and that the machine is tagged out,
- Prior to any operation, check that the voltage on the identification plate of the appliance corresponds to the main voltage available on site,
- The warranty will automatically become void if any safety device is removed or shunted. This will also apply if any parts are replaced with parts purchased anywhere else than from our stores,
- Keep the appliance out of the reach of children,
- Do not discharge R407C fluid into the atmosphere: R407C is a fluorinated greenhouse effect gas, covered by the Kyoto Protocol, with a Global Warming Potential (GWP) = 1653 - (Directive EC 842/2006).
- According to French decree no. 2007-737 of 7th May 2007, if the appliance has more than 2 kg of refrigerant gas (refer to manufacturer specifications), the cooling circuit must be checked for leakage at least once a year. This operation must be carried out by a certified cooling appliance specialist

# Summary

<b>1. Information before installation</b> .....	<b>2</b>
1.1 General terms of delivery, storage and transport .....	2
1.2 Content .....	2
1.3 Operating conditions .....	3
1.4 Technical specifications .....	3
<b>2. Installation</b> .....	<b>3</b>
2.1 Installation requirements .....	3
2.2 Access to technical compartment.....	4
2.3 Connection to surrounding air .....	4
2.4 Inset connection .....	5
2.5 Connection of the condensation drainage .....	5
2.6 Electric connections .....	5
2.7 Connecting the options.....	9
<b>3. Operation</b> .....	<b>9</b>
3.1 Starting the appliance .....	9
3.2 Checks .....	10
3.3 Adjusting the duct network .....	10
3.4 Options starting up .....	10
<b>4. Maintenance</b> .....	<b>11</b>
4.1 Maintenance instructions .....	11
4.2 Additional recommendations .....	11
4.3 Spare parts .....	12
4.4 Recycling the product .....	12
<b>5. Resolution of problem</b> .....	<b>12</b>
5.1 Status and faults in the ECP 600 settings.....	12
5.2 FAQ.....	14
<b>6. Product registration</b> .....	<b>14</b>
<b>7. Conformity certificate</b> .....	<b>14</b>

 Available in the appendices at the end of the manual:  
 - wiring diagrams  
 - Dimensions

## 1. Information before installation





### 1.1 General terms of delivery, storage and transport



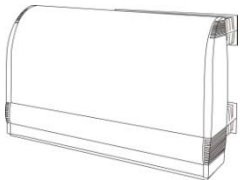

Any equipment, even carriage and packing free, travels at the consignee's risk. The consignee shall make reservations in writing on the carrier's bill of lading if damage is detected, caused during transport (confirmation to be sent to the carrier within 48 hours by registered mail with acknowledgement of receipt).

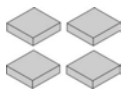
**The device must be transported and stored upright on its pallet in its original packaging.**

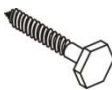
If the device has been turned on its side, mention your reservations in writing to the carrier.

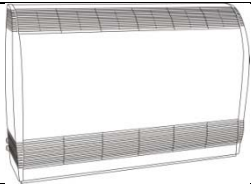
### 1.2 Content

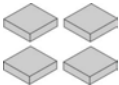
					
<b>Sirocco inset(x1)</b>	sleeve (x2) + frame with cadre suction grid and filter (x1) + frame with blowing grid (x1) + frame fixture kit (x1)	Hygro Control (x1)	anti-vibration studs (x4)	dowel (x2)	long bolt (x2)

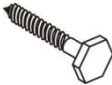
				
Sirocco ambient (x1)	Hygro Control (x1)	anti-vibration studs (x4)	dowel (x2)	long bolt (x2)

### 1.3 Operating conditions

- operating range: 10°C to 40°C (temperature in the swimming pool hall)
- optimum operating conditions: between 25 °C and 30 °C
- Hygro Control on request

### 1.4 Technical specifications

Appliance	Dehumidifying capacity *	Power consumed *	Power restored on the ambient air*	Air flow-rate
Without option	L/h	W	W	m <sup>3</sup> /h
Sirocco 55	2.3 L/h	990 W	2080 W	600 m <sup>3</sup> /h
Sirocco 80	3.3 L/h	1100 W	2310 W	800 m <sup>3</sup> /h
Sirocco 110	4.6 L/h	1340 W	2810 W	1000 m <sup>3</sup> /h

\* with ambient air at +30 °C and relative humidity of 70%

- unit protection class: Sirocco ambient: IP 44 ; Sirocco inset: IP 45
- class: I
- refrigerant gas: **R407C**
- refrigerant charge: see product information plate

## 2. Installation

### 2.1 Installation requirements

- **Install the appliance on a level base**, to avoid any overflows from the condensation tray (adjustment by two hexagonal screws, see §2.2),
- **Easy access to the appliance for maintenance and connections**,
- **Place nothing in front of or on the blowing and suction grates**,
- **anti-vibration studs** (supplied) **must be installed** under the base when the appliance is placed on the floor or on a support,
- **For a swimming pool building with a high ceiling or visible roof frame**: destratification of the upper layers of the room = one or several fans with PVC blades **or** an air extractor with fresh air intake.  
**Warning!** 230 V AC appliances = must be outside volume 1 (see §2.1),

- **Risk of stratification:**

- height of the room < 4 to 5 meters: mechanical ventilator unit or extractor,
- height of the room > 5 to 8 meters: ceiling fans with large blades.

- **Building requirements:** swimming pool building = very damp room,

During building make sure that:

- the materials used are compatible with a swimming pool environment,
- the walls are sufficiently waterproofed and insulated to avoid condensation forming in the room when relative humidity reaches 60 to 70%,

Light structure buildings (verandas, shelters...): there is no risk of deterioration of the structure, even in case of dew as they are designed to support this (even with a relative humidity of 70%),

- **Ventilation**, renewal of air:

- private pools: highly recommended,
- public pools: compulsory.

The air can be renewed by:

- a simple mechanical ventilation unit,
- a wall or roof extractor with fresh air intakes,

This ventilation ensures the hygienic renewal of air, the removal of any chloramines present in the air, and the elimination of excessively hot air, whilst contributing to the dehumidification of the room.

• Following French norm NFC 15-100, the appliance should be installed:

- Outside of area 1 (more than 2 metres from the edge of the pool) provided it is out of reach of potential splashes and protected by a dedicated 30 mA fuse,
- Outside of area 2 (more than 3.5 metres from the edge of the pool) if the above conditions are not satisfied.



## 2.2 Access to technical compartment

Adjusting screw to level the appliance

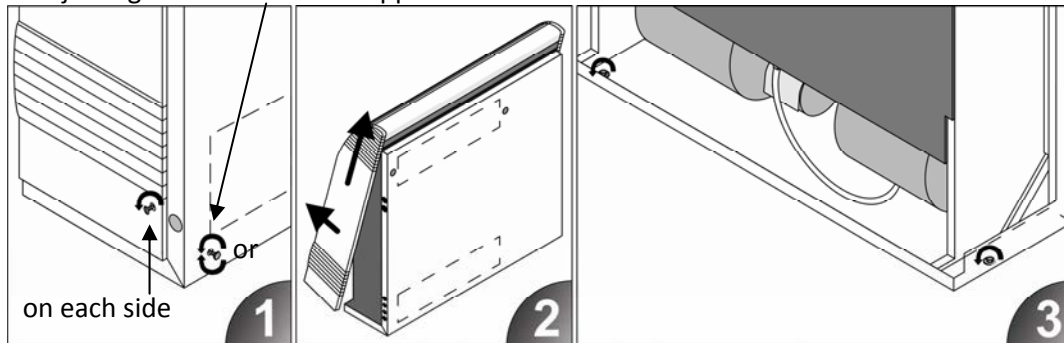

## 2.3 Connection to surrounding air

### 2.3.1 Appliance on the ground (or on a support)

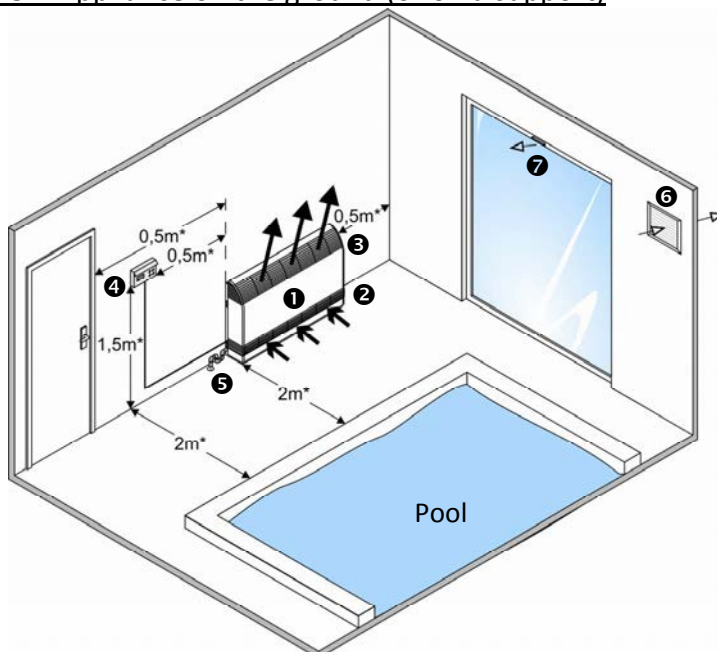

\* minimum distance

\*\* maximum distance

① Sirocco 55-80-110

② suction grid

③ blowing grid

④ Hygro Control

⑤ condensation drainage

⑥ air renewal system (see §2.1)

⑦ fresh air intake

### 2.3.2 Appliance fixed to the wall

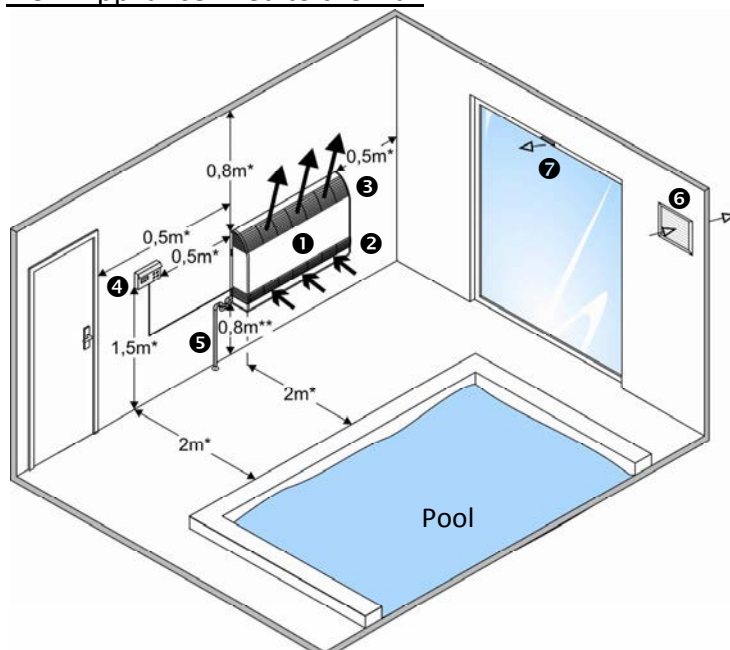

Using the two anchoring points at the back of the appliance (with two bolt screws, washers and plugs (supplied) in a "solid wall").

## 2.4 Inset connection

- Install the appliance in a technical room that is protected from freezing.
- the sleeves are:
  - to be incorporated in the wall at the time of construction,

**! The blocks of polystyrene must remain in the sleeves to protect them from crushing.**

- or for sliding into the previously made reservations in the wall,

		Sirocco 55	Sirocco 80	Sirocco 110
Reserve dimensions (+2 mm / -0 mm)	mm	618 x 165	808 x 165	998 x 165

- plan for a gasket between the wall and the outside surface of each sleeve of the technical room and swimming pool room side,
- present the base of the appliance (without the cover) to the wall, opposite the sleeves and mark the two inside anchoring points,

**! At this moment, the frames fixed to the back of the appliance must easily slot into each sleeve.**

- install the fixing plugs into the “solid wall” using the marks,
- present the appliance again and from the inside screw in the bolt-screws + washers into each plug,
- plan for an earth for the blowing and suction grid frame, following the electrical standards in force in the country.

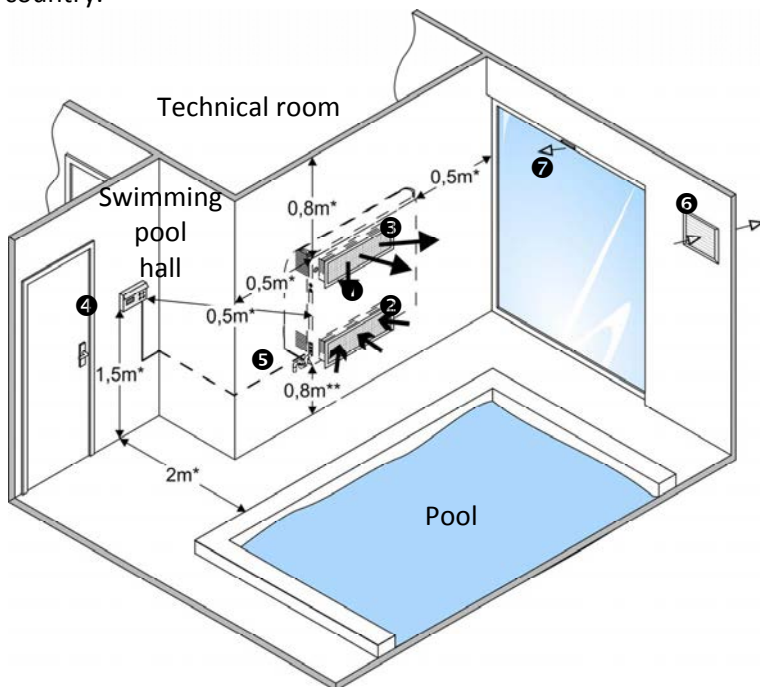

\* minimum distance

\*\* maximum distance

- ❶ Sirocco 55-80-110
- ❷ suction grid
- ❸ blowing grid
- ❹ Hygro Control
- ❺ condensation drainage
- ❻ air renewal system (see §2.1)
- ❼ fresh air intake

## 2.5 Connection of the condensation drainage

Plan for an adequate slope to ensure a good flow. Drainage shall be via a siphon or a funnel (condensation drainage pipe  $\varnothing 12/18$ ). Outlet provided for at the left of the appliance (condition ex-works), with possibility of moving it to the right. Make sure the siphon is filled with water in such a way as not to create air suction by the condensation drainage pipe.

For placing the condensation drainage: see mark “A  $\varnothing 12/18$ ” § “dimensions” in the appendix.

## 2.6 Electric connections

### 2.6.1 Access to the electric box

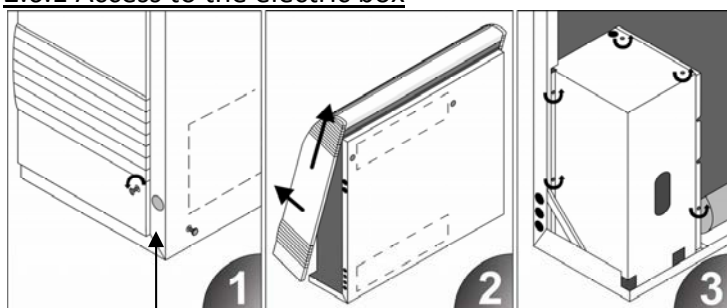

On each side

### 2.6.2 Voltage and protection

- The electrical supply must be provided through a protection and circuit breaking device (not supplied) complying with the standards and regulations in force in the country where it is installed,
- Electrical protection: 30 mA ground fault circuit breaker.

• **Acceptable voltage variation tolerance: ± 10% (during operation),**  
 • **Electric cables must be fixed,**

### 2.6.3 Connections

Terminal Sirocco single-phase 230V-1N-50Hz:

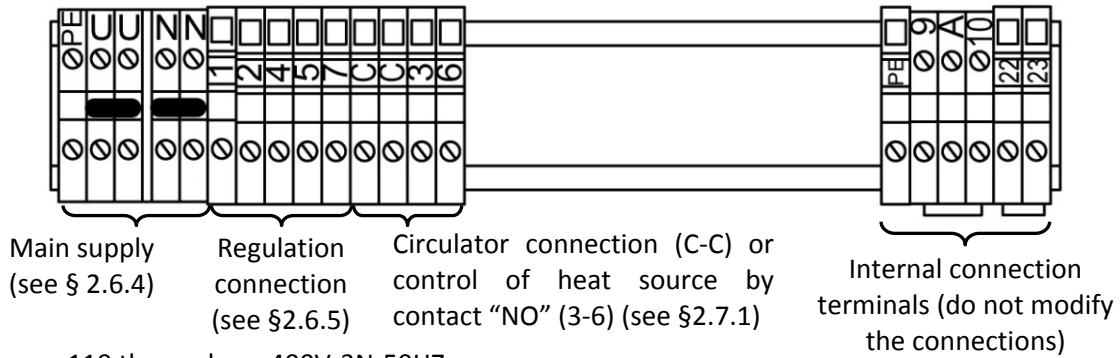

Terminal Sirocco 110 three-phase 400V-3N-50HZ:

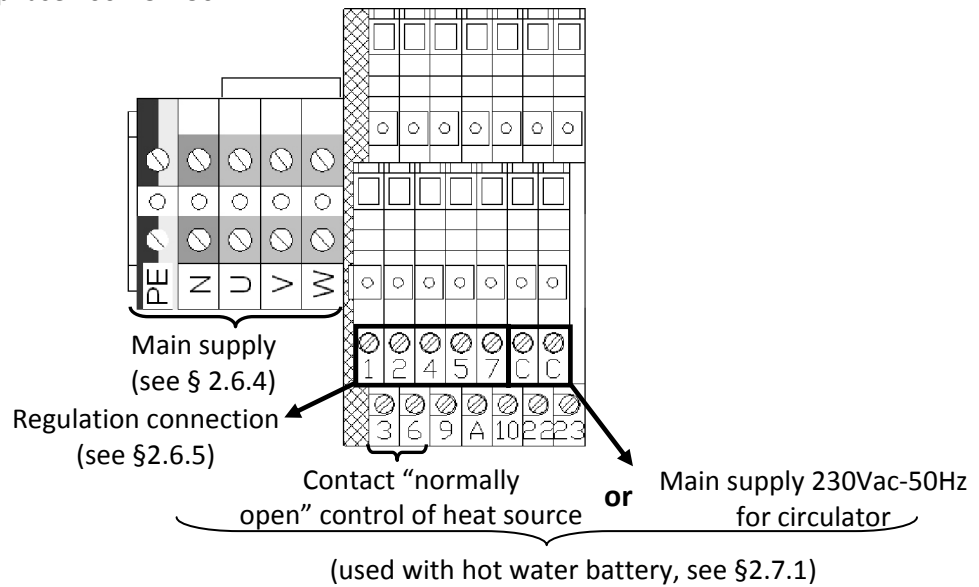

• **Loose terminals may cause the supply terminal board to overheat, and will void the warranty.**  
 • **The appliance must be earthed.**  
 • **Risk of electrical shock inside the device. Only a qualified and experienced technician must install the device cables. If the power cable is damaged it must be replaced by a qualified technician.**

### 2.6.4 Cable sizes

- Supply cable size: for cables of a maximum length of 20 metres (calculation basis: 5A/mm<sup>2</sup>), this must be checked and adapted depending on installation conditions.

Unit	Option	Voltage	Nominal power consumption	Maximum power consumption	Cable size	
			A	A	mm <sup>2</sup>	
Sirocco 55 Single-phase	without option or hot water battery	230V-50Hz-	4,45	5,9	3 x 2,5	3G2,5
	Extra heating 2 kW	230V-50Hz-	13,2	14,6	3 x 4	3G4
Sirocco 80 Single-phase	without option or hot water battery	230V-50Hz-	5,05	8	3 x 2,5	3G2,5
	Extra heating 3 kW	230V-50Hz-	18	21	3 x 6	3G6
Sirocco 110 Single-phase	without option or hot water battery	230V-50Hz-	6,35	9,8	3 x 2,5	3G2,5
	Extra heating 4,5 kW	230V-50Hz-	26	29,4	3 x 10	3G10
Sirocco 110 three-phase	without option or hot water battery	400V-50Hz-	2,8	3,8	5 x 2,5	5G2,5
	Extra heating 4,5 kW	400V-50Hz-	9,3	10,3	5 x 2,5	5G2,5

### 2.6.5 Hygro Control connection

**i** Hygro Control = digital display hygro-thermostat = display and setting of pool hall temperature\* and humidity

- for installation location: see §2.3 or §2.4 and refer to § 2.1,
- correctly influenced by the swimming pool room air,
- connect to terminals on the electric box.

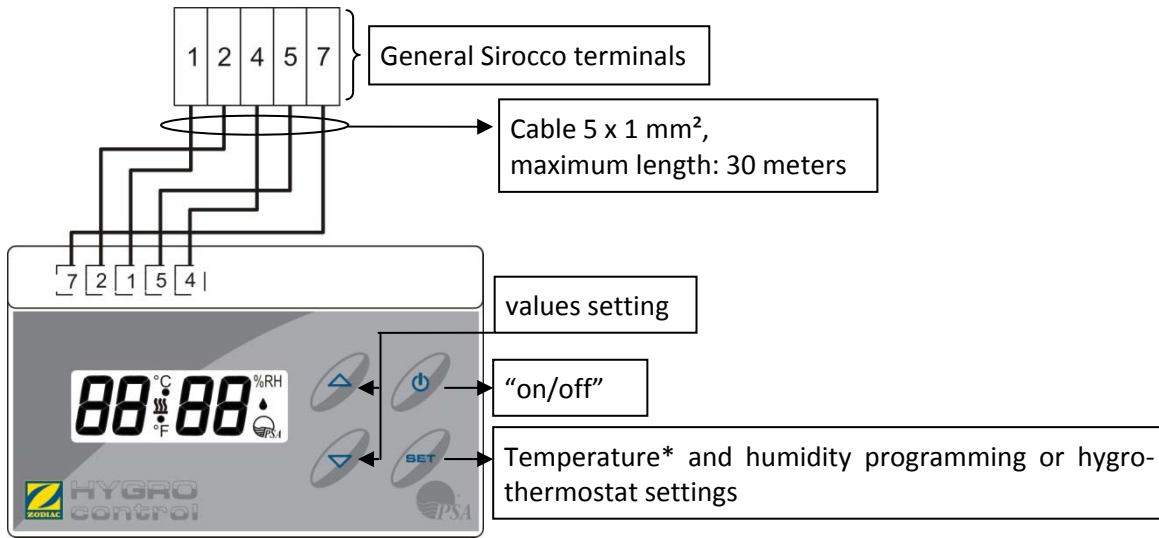

- !**
- Mains supply 12Vac-50Hz- between terminals 4 and 5,
  - The numbering of the terminals must be respected,
  - Do not put these cables into the same duct as other 230 V or 400 V to avoid any risk of interference of the signals,
  - Obstruct the place where the cable emerges from the wall or seal it by using materials other than silicone and silicone-based materials, in order to avoid any arrival of air exterior to the room through the duct or dividing wall.

#### Technical specifications

Admissible room temperature	°C	0-55	
Admissible humidity level	%	0-90	
Voltage	Vac	12	
Maximum voltage	Vac	24	
Protection index	IP	20	
Dimensions: width / height / depth	mm	120 x 70 x 28	
Hysteresis	Humidity	%	4
	temperature	°C	1

#### Display

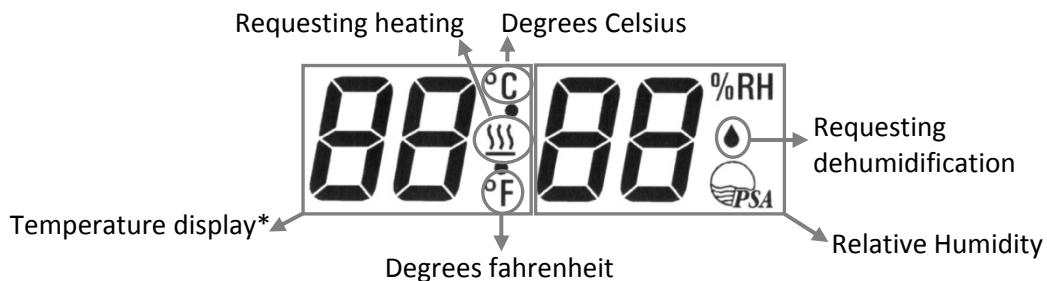



**!** \* Only if your appliance is fitted with the hot water battery option, or extra electric heating.

Hygro Control display	Hygro-thermostat	Hygrostat	Thermostat
On standby	-- --	--	--
Active	28°C 65%RH	65%RH	28°C



By default: display of the temperature and/or desired relative humidity.



-  Display of the ambient temperature and/or humidity by pressing  once, "°C" and/or "%RH" blink. To exit, press , or wait 10 seconds.

### Starting up and stopping the appliance





Press  for 5 seconds.

### Locking/unlocking the keyboard

To lock and unlock the keyboard:

- Hygro Control must be **active**,
- press  and  simultaneously for 3 seconds,
- the  message is displayed or is removed.

### Adjusting the reference values

- Hygro Control must be **active**,
- press  for 3 seconds, the modifiable value blinks,
- use  or  to set the value,
- press  to validate,
- and then  to exit.





Value range	minimum	maximum
Humidity	55%	70%
Temperature	5 °C	32 °C



Comfort setting
65%
28°C

-  If the keyboard is not used for 30 seconds, the setting will be abandoned and the last (non validated) setting will not be taken into account.

### Test mode / Manual override









To force the appliance to operate for 30 minutes, even if the pool hall conditions do not trigger the request:

- Hygro Control must be **active**,
- press on  for 3 seconds, a value blinks,
- press  again for 10 seconds,
- all the digits light ,  or  and the appliance starts up.

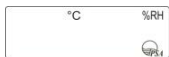
-  To quit this mode, press the  button for 5 seconds.

### Parameter setting in hygro-thermostat or hygostat mode

-  Hygro Control shipped with the setting for hygro-thermostat mode for appliances with the heating option for hygostat mode for devices without the heating option. This setting must be changed if a heating option is added or removed.

- Hygro Control must be **on standby**,
- press  and  for 3 seconds :  (hygro-thermostat mode),
- press  or  to select the function:  (hygostat mode),  (thermostat mode)
- validate by pressing .

## 2.7 Connecting the options

### 2.7.1 Hot water battery

Connections on  $\varnothing 15-21$ , male fitting. Outlet must be **obligatorily on the left** seen from the front.

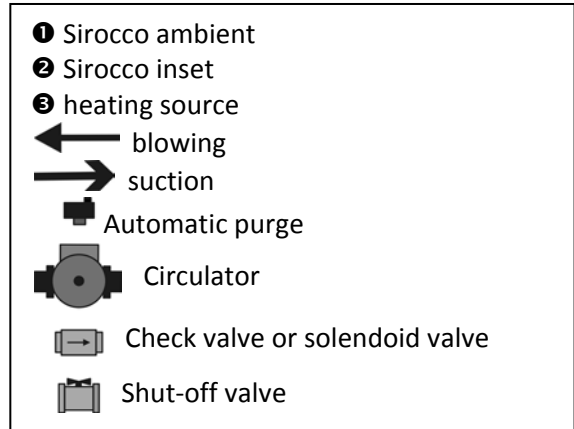
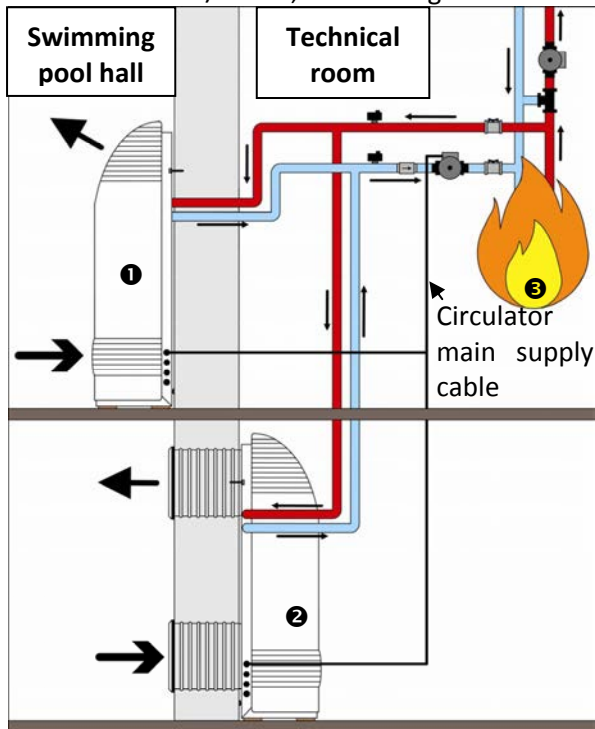

Primary	Power		Water flow rate		Water load loss	
	90/70°C	45/40°C	90/70°C	45/40°C	90/70°C	45/40°C
Unit	kW		m <sup>3</sup> /h		mCE	
Sirocco 55	6	2.1	0.25	0.35	0.41	0.77
Sirocco 80	9	2.6	0.42	0.46	0.37	0.47
Sirocco 110	12	3.3	0.53	0.58	0.65	0.83

Power restituted to the air at 27°C, entering the hot water battery.



- Connection to the primary circuit: front any valve or pump.
- Water temperature input to the hot water battery: 45 °C minimum, 90°C maximum.
- Maximum pressure water battery circuit: 3 bars.

## 3. Operation

### 3.1 Starting the appliance

- Power on the appliance (by switching on the general terminal board),
- Only for three-phased Sirocco 110: when the dehumidifier is switched on, check the status of the phase controller (KA4):
  - None of the indicators are lit = no power supply,
  - Green and orange indicators are lit = normal operating conditions,
  - Only green indicator lit = power supply is ok but phase inversion issue or missing phase. Cut off the power supply and invert two phases directly on the appliance connection terminal board. If the orange indicator does not light up after the phase inversion, check for the presence of the three phases on the phase order controller KA4.



**This operation must be only be carried out by a qualified professional.**

**The phase order controller protects the compressor. It's forbidden to invert phases:**

- on the power contactor (KM2)
- on the compressor

- set the humidity and temperature on the Hygro Control so that it triggers dehumidifying, see §2.6.5.



**When the "ECP 600" regulator is switched on ventilation is active for 5 minutes. This also occurs if the appliance is powered on and the "on/off" switch of the Hygro Control delivered with the appliance is used.**

## 3.2 Checks

In the Hygro Control comfort model (see §2.6.5)

- check that hot air is coming out of the blower grates,
- check that the appliance is draining condensation.

## 3.3 Adjusting the duct network

Set the air flow by adjusting the grate dampers (recommended speed  $\approx$  1metre/second) identically on all the blower grates.

## 3.4 Options starting up

The heating options are operational from 4°C surrounding air temperature.

### 3.4.1 Extra heating

- starting up Hygro Control and adjust the thermostat to between 26 and 28°C (maximum 30°C), in general choose an air temperature 1 to 2°C higher than the pool water temperature,

 if your pool has a cover (shutter or bubble sheet type, etc.), you can lower the room temperature when it is in place (by adjusting the thermostat to about 20°C) and raise the pool hall temperature before removing the cover.

- check that with the “VI/VP” switch on “VI”, and no dehumidification or defrosting cycles in progress:
  - the fan stops operating, after post-ventilation of 3 minutes when the reference room temperature on the pool room thermostat is lowered,
  - in the event of abnormal overheating, the appliance shuts down the heating option automatically, by shutting off the heating elements and keeping the ventilation operational (for as long as a heating request is active).

This safety device has two levels of triggering:

- 1) by “THS” safety thermostat if the T°C is > 65°C (it is automatically reset),
- 2) if the temperature continues to increase, the second positive “THSM”  safety thermostat puts the appliance into safety mode.

=> reset it manually (with power off), after having checked that the appliance air flow is correct (with the “VI/VP” switch on “VP”), that the grates are not obstructed, that the filter is not clogged, and the fan is not defective.

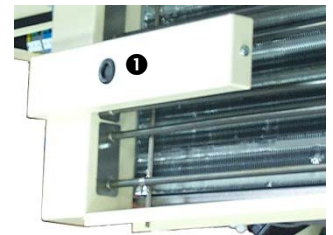

### 3.4.2 Hot water battery

- Supply the battery with hot water at 45 °C minimum from the heat source (boiler, heat pump, geothermal energy, solar heating), installation must be carried out by a qualified technician, using a circulator (not supplied) which will be powered by terminals C-C on the electrical terminal board.

 Insulate the hot water battery hot water pipes between the heat source and the appliance (for the purpose of limiting calorie loss).

- connection to a ZPCE double circuit gas boiler: connect the terminals 3-6 of the terminal board, to terminals 3-6 of the boiler terminal board,

 Terminals 3-6 can also ensure a heat source control function (see §2.6.3).

- adjust the thermostat between to 26 and 28°C (maximum 30°C), in general set the air temperature 1 to 2°C higher than the pool water temperature,

 If your pool has a cover (shutter or bubble sheet type, etc.), you can lower the room temperature (by adjusting the thermostat to about 20°C) when it is in place and raise the pool hall temperature before removing the cover.

- a post-ventilation runs for 3 minutes when the reference temperature is reduced on the thermostat located in the pool hall (with the “VI/VP” switch on “VI”, without any dehumidification or defrosting cycles in progress): check that the circulator stops.

 **Warning - low temperature:** if the dehumidifier hot water battery is not supplied by a boiler, but by an aero-thermal or a geothermal system, the heating circuit water will be at a maximum temperature of 45-40°C. The power of the battery will then be considerably lower (3 to 4 times less) than the nominal power given for water at 90-70°C. If the power of the battery is lower than the heating needs of the room, plan for additional heating by radiator, heated floor or fan convector.

## 4. Maintenance

### 4.1 Maintenance instructions



A general servicing of the appliance is recommended both when winterizing and when restarting in order to ensure the proper operation of your heat pump, to preserve its performance and to prevent potential failures.

**Servicing costs will be borne by the user.**



**Appliance powered off and unplugged from power supply!  
The appliance must have filters fitted when operating.**

#### 4.1.1 Monthly checks

- check visually that the condensation is drained.
- check for clogging in the filter:



- wash the filter with warm soapy water,
- rinse it abundantly and dry it,
- replace it if necessary.

#### 4.1.2 Annual checks

- check that the electric cable connections, contactors are correctly tightened,
- check that each command relay, power switch and electronic protection device is operational,



On the three-phase Sirocco 110, via the phase controller (KA4), any modification of the order of phases on the distribution network or on the existing electrical installation is detected. The appliance then goes into fault mode (Led A1 and A3 ON, and orange light OFF for KA4), refer on §3.1.

- check the adjustment and operation of the Hygro Control and the water condenser thermostat if necessary clean the dust inside it using a jet of air,
- clean the whole unit with a slightly damp cloth,
- check the cleanliness of the condensation drainage tray and tube,
- to improve the operation of the appliance, it is possible to make a visual check of the fouling of the batteries (evaporator / condenser and hot water) by removing the cover from the appliance (switched off). Depending on the condition, clean with a silk brush and a vacuum cleaner.

### 4.2 Additional recommendations

#### in relation to the Pressure Equipment Directive (PED-97/23/CE)

##### 4.2.1 Installation and maintenance



- the unit may not be installed close to combustible materials, or the air duct inlet of an adjacent building .
- with some devices, it is essential to fit protection grids if the unit is installed in an area with uncontrolled access.
- during installation, troubleshooting and maintenance, pipes may not be used as steps: the pipe could break under the weight, spilling refrigerant and possibly causing serious burns.
- when servicing the appliance, the composition and state of heat carrying fluid must be checked, as well as the absence of any refrigerant.
- during the annual unit sealing test in accordance with applicable legislation, the high and low pressure switches must be checked to ensure that they are securely fastened to the coolant circuit and that they cutoff the electrical circuit when tripped.
- during maintenance work, ensure there are no traces of corrosion or oil around cooling components.
- before beginning work on the cooling circuit, stop the device and wait for a few minutes before fitting the temperature and pressure sensors. Some elements such as the compressor and piping may reach temperatures in excess of 100°C and high pressures with the consequent risk of severe scalding.

##### 4.2.2 Troubleshooting

- all soldering work must be carried out by a someone qualified to do so.
- replacement pipes must always be made of copper in compliance with standard NF EN 12735-1.

- leak detection; pressure test:
  - never use oxygen or dry air, risk of fire or explosion,
  - use dry nitrogen or the mixture of nitrogen and refrigerant indicated on the information plate,
  - the test pressure for both the high and low pressure circuits must not exceed 20 bar and 15 bar in the case the device is equipped of the manometer option.
- the high pressure circuit pipes are made of copper and have a diameter equal to or greater than 1”5/8. A certificate as indicated in §2.1 in compliance with standard NF EN 10204 will be requested from the supplier and filed in installation technical documentation.
- technical data relative to the safety requirements of the various applicable directives must be indicated on the information plate.
- This data must be recorded in the installation instructions for the device which are included in the installation technical file: model, code, serial number, maximum and minimum OT, OP, year of manufacture, EC label, manufacturer’s address, refrigerant and weight, electrical parameters, thermo-dynamic and acoustic performances.**

### 4.3 Spare parts

Spare parts	Item number	Representation
Hygro Control sensor	WCE03431	
Filter		
Sirocco 55 inset	WSD01911	
Sirocco 80 inset	WSD01912	
Sirocco 110 inset	WSD01913	
Sirocco 55 ambient		
Sirocco 80 ambient	WSD01914	
Sirocco 110 ambient	WSD01915	

### 4.4 Recycling the product



This symbol means that the equipment must not throw it into your household waste. It will be collected selectively so that it can be reused, recycled or recovered. Any substances it may contain which are potentially dangerous to the environment will be eliminated or neutralised.  
 Enquire with your retailer for the conditions that apply to the recycling of your product.

## 5. Resolution of problem

### 5.1 Status and faults in the ECP 600 settings

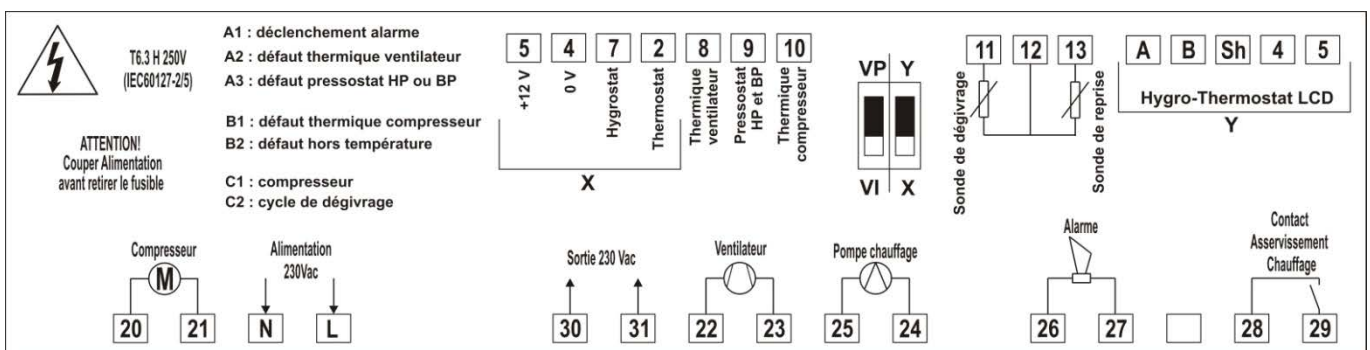

Terminals	Description
N - L	mains-supply 230Vac-50Hz to the ECP600 regulator
20 - 21	output from compressor supply 230 Vac -50Hz
30 - 31	230Vac-50Hz output (used with the water condenser option) and protected by the ECP600 fuse
22 - 23	ventilator 230Vac-50Hz output
25 - 24	output for circulator hot water battery option 230Vac-50Hz
26 - 27	output alarm report 230Vac-50Hz
28 - 29	output contact “NO” (without polarity) control of heat source hot water battery option
11 – 12 - 13	Input control sensor type PTC (inlet or defrost)
4 - 5	power supply 12Vac-50Hz

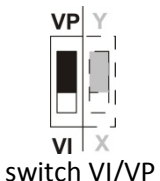
Terminals	Description
7	input 6Vac-50Hz given by the hygrostat function (request active if 6Vac-50Hz between 7 and 4)
2	input 6Vac-50Hz given by the thermostat function (request active if 6Vac-50Hz between 2 and 4)
8	input 12Vac-50Hz fan heat fault (shunted not active) (fault active if 0Vac-50Hz between 8 and 4, LEDs A1 and A2 are ON)
9	input 12Vac-50Hz faults BP and/or HP, and/or phase order (Sirocco three-phase) (fault active if 0Vac-50Hz between 9 and 4, LEDs A1 and A3 are ON)
10	input 12Vac-50Hz compressor heat fault (shunted not active) (fault active if 0Vac-50Hz between 10 and 4, LEDs A1 and B1 are ON)
Hygro-Thermostat LCD A-B-Sh-4-5	Not used
 switch VI/VP	<p>“intermittent ventilation” (standard setting) or “permanent ventilation” (to permanently circulate the pool hall air)</p> <p>The ventilation is active when:</p> <ul style="list-style-type: none"> <li>- dehumidification is triggered,</li> <li>- a defrosting cycle is started,</li> <li>- pool hall air heating is triggered,</li> <li>- <b>active for at least 5 minutes in one hour without any of these triggers.</b></li> </ul> <p>On VP, the compressor starts after a delay of 1 minute.</p>

Leds	Description
A2 fan heat fault	Sirocco : Not used
A3 high or low pressure switch fault	triggering HP and/or LP switch and/or phase order relay KA4 (only on Sirocco three-phase) <ul style="list-style-type: none"> <li>- HP : check that the ventilator is operational, that the air filter is clean and the belt is tight enough,</li> <li>- LP: insufficient gas, call a specialist,</li> <li>- KA4: check for the presence of the 3 phases, if so, see §3.1.</li> </ul>
B1 compressor heat fault	Sirocco : Not used
B2 temperature range fault	<ul style="list-style-type: none"> <li>- restart sensor is out of order</li> </ul> If the returns to within its operating range: <ul style="list-style-type: none"> <li>- there is a 10 seconds delay before the fault is cleared,</li> <li>- there is a minute delay before restarting the compressor (if a dehumidification request is still active)</li> </ul>
C1 compressor	Non-blinking and ON = compressor operating blinking = temporisation in process
C2 defrosting cycle	<ul style="list-style-type: none"> <li>- cooling circuit temperature &lt; than -5°C or &gt; than 40°C,</li> <li>- a defrosting cycle is in progress (temperature is &gt;-5°C). The compressor is stopped and ventilation is maintained,</li> <li>- the defrosting sensor is out of order.</li> </ul> The defrosting cycle stops when the temperature of the sensor goes over 3.2°C. In all cases, if the ventilator is active before the triggering of this fault, ventilation is maintained. If the sensor returns within its operating range: <ul style="list-style-type: none"> <li>- there is a delay of 10 seconds before the fault is cleared,</li> <li>there is a minute delay before the compressor restart (if a dehumidification request is still active)</li> </ul>

## 5.2 FAQ

<b>Why is my appliance draining water?</b>	Your appliance gives off water, called condensation. This water is the humidity your dehumidifier condenses to dry the air.
<b>Why are my french windows covered with water whilst my appliance is dehumidifying?</b>	This is the dew point, which means the moment when the water vapour contained in the air will change states when in contact with a cold surface. This is the phenomenon of condensation. This does not mean your appliance is not working. This phenomenon is normal, because of the presence of humidity in the air (65% humidity in comfortable conditions), and a cold outside temperature.

## 6. Product registration

---

Register your product using our website:

- you will be among the first to be informed of new Zodiac products and special offers,
- You can help us to constantly improve our product quality.

Australia – New Zealand	<a href="http://www.zodiac.com.au">www.zodiac.com.au</a>
South Africa	<a href="http://www.zodiac.co.za">www.zodiac.co.za</a>
Europe and rest of the world	<a href="http://www.zodiac-poolcare.com">www.zodiac-poolcare.com</a>

## 7. Conformity certificate

---

Z.P.C.E. declares that the following products or ranges:

**Special pool dehumidifier: Sirocco 55-80-110 inset and ambient**

are in compliance with the provisions of:

- **Electromagnetic compatibility directive 89/336/EEC**
- **Low voltage directive 73/23/EEC, as amended by 93/068/EEC**
- **The following harmonised standards have been applied: EN 60335.2.40**



# Notes

A series of horizontal dashed lines for writing notes, arranged in a grid pattern across the page.



# Electric diagram

## Sirocco 55-80-110 single-phase

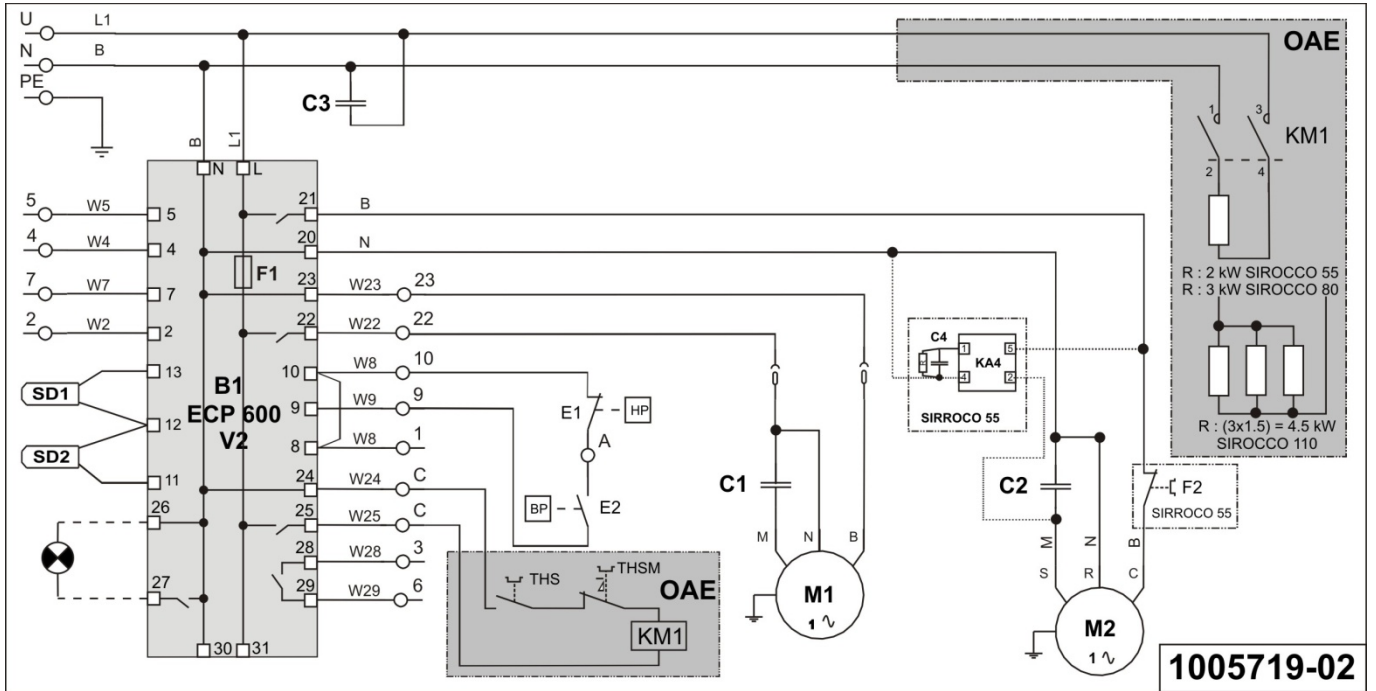

## Sirocco 110 three-phase

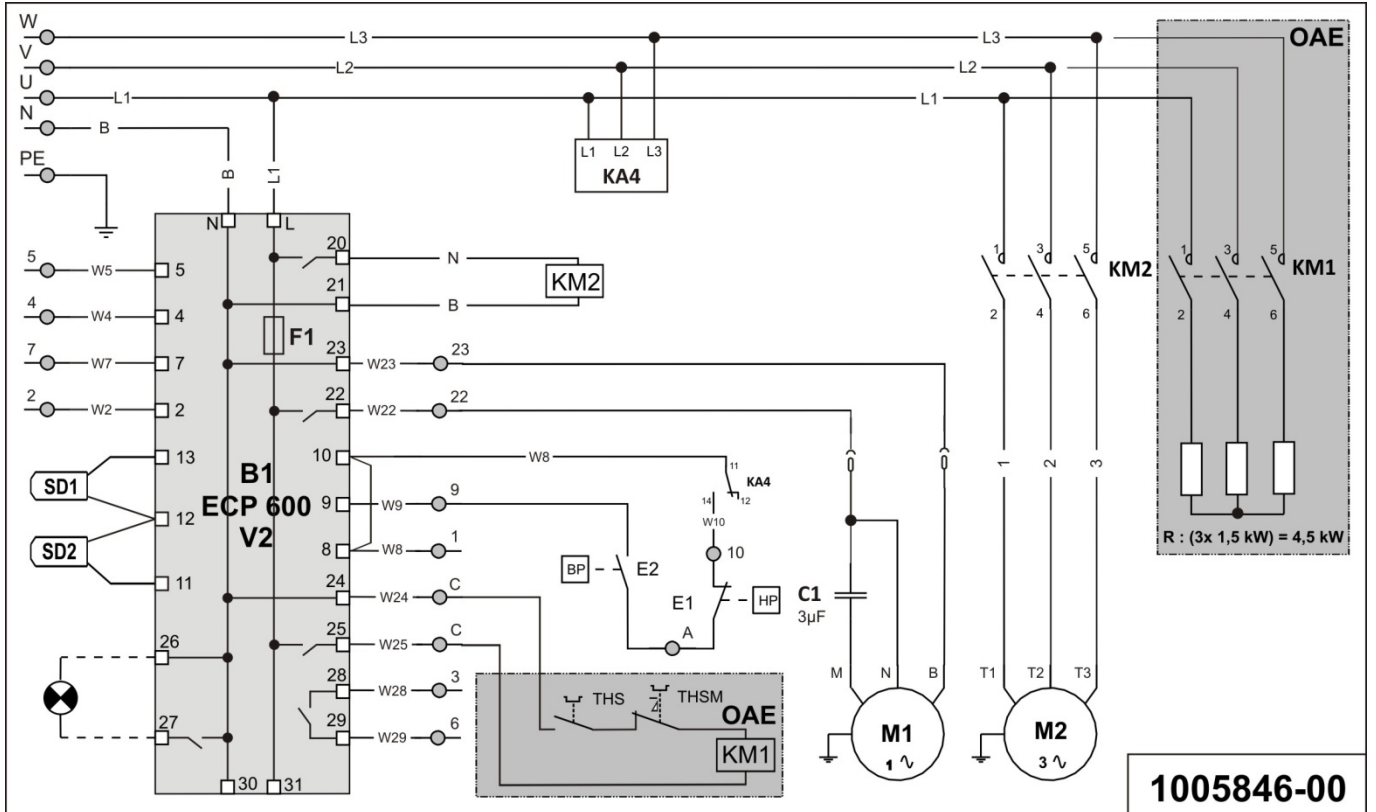

U-N	single phase main supply 230Vac-1N-50Hz
U-V-W-N	three phase main supply 400Vac-3N-50Hz
PE (⏚)	Earth
3-6	control of heating for ZPCE type boiler or an existing heating system
C-C	supply (230Vac-50Hz) for battery circulator or used for electric logic of the heating option by electric backing
5-7-2-4-1	connection of Hygro Control (see §2.6.5)
26-27	supply (230 V AC -50 Hz) for remote fault warning light or relaying
B1	command logic controller ECP 600
C1	ventilator capacitor
C2	compressor capacitor
C3	filtering capacitor
C4	starting relay capacitor
E1	high pressure switch
E2	low pressure switch
F1	Fuse T=6.3A – 5 x 20
F2	Compressor internal thermal protection
KA4	starting relay or phase order relay on Sirocco three phase
KM1	power contactor of back up heating resistor
KM2	compressor power contactor
M1	ventilator motor (230Vac/50Hz)
M2	compressor motor (230Vac/50Hz)
OAE	back up heating option
R	heating resistor
SD1	air inlet sensor (black sheath)
SD2	defrost sensor (grey sheath)
THS	high limit thermostat (automatic reset)
THSM	positive high limit thermostat (manual reset)
N	black
B	blue
M	brown

## Dimensions

### without option

	Weight (Kg)	A	B	C
	Kg	mm		
Sirocco 55	65	1030	620	653
Sirocco 80	75	1220	810	843
Sirocco 110	85	1410	1000	1033

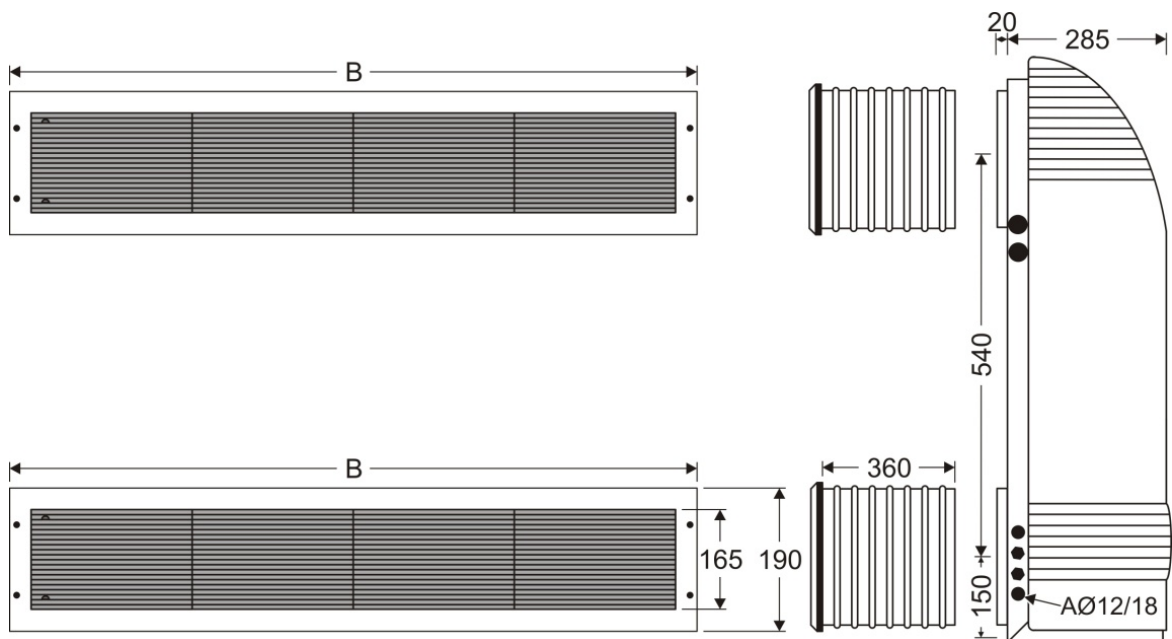
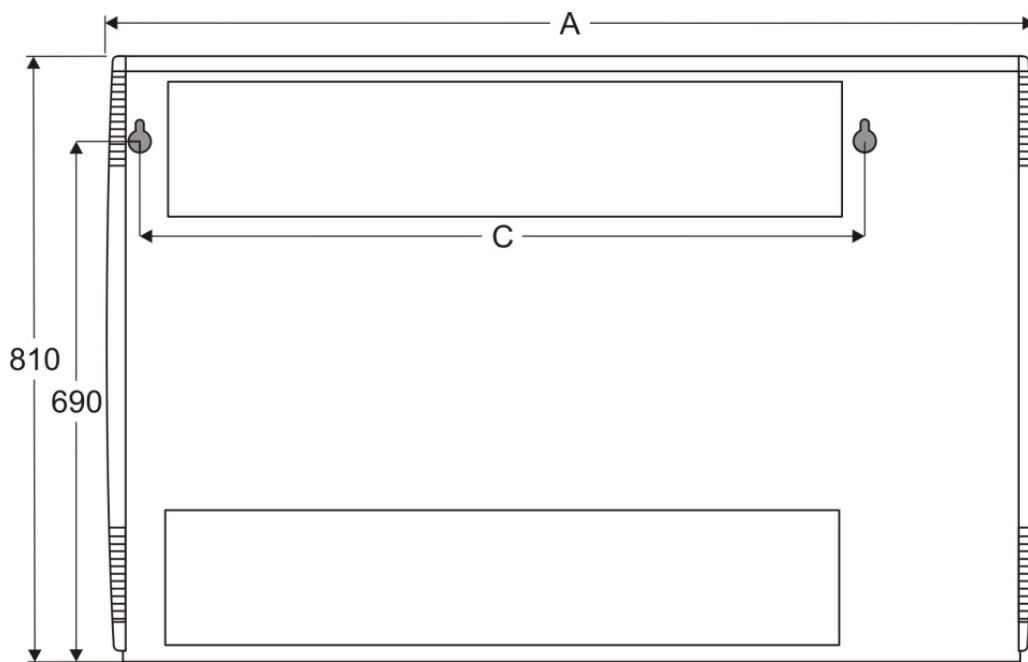
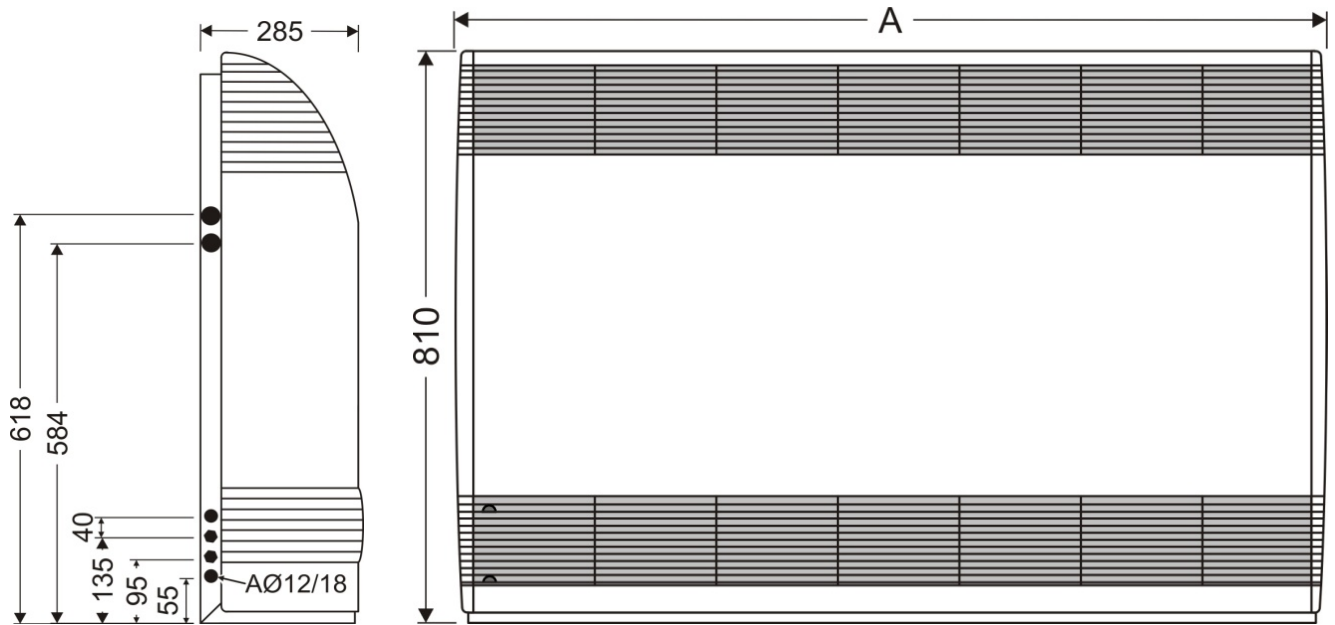

[www.zodiac-poolcare.com](http://www.zodiac-poolcare.com)

Pour plus de renseignements, merci de contacter votre revendeur.  
For further information, please contact your retailer.

Votre revendeur / your retailer