

FLO PRO™ VS

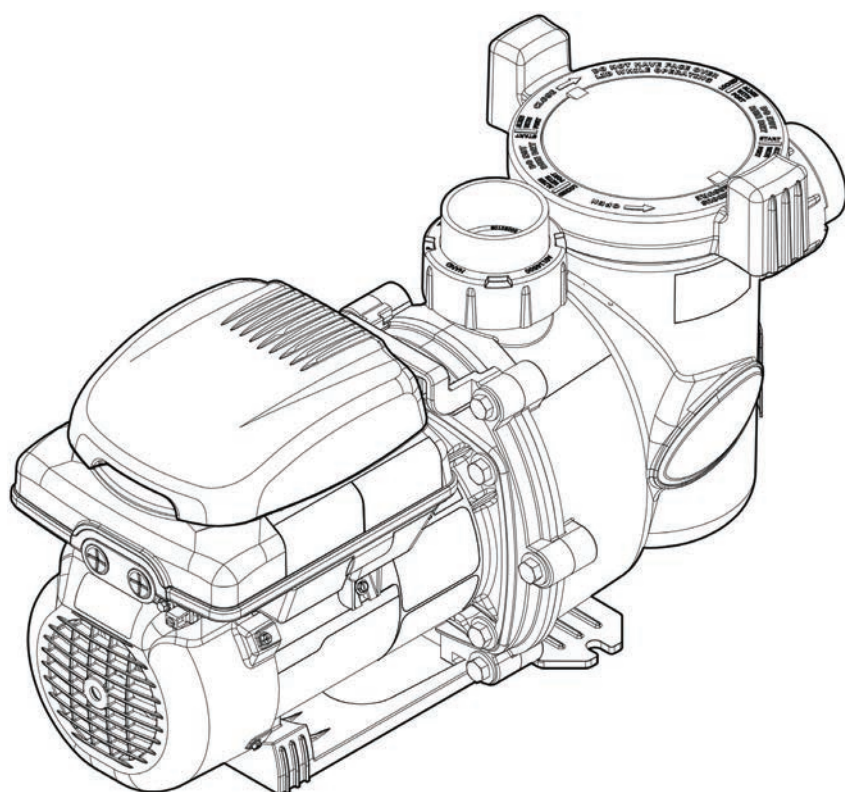



Instructions for installation and use
English

EN

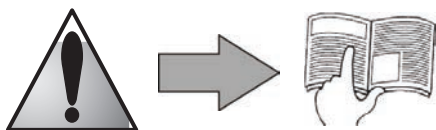
More documents on:
www.zodiac.com



- Read this notice carefully before installing, maintaining or repairing this appliance!
- The symbol  indicates important information that it is imperative to take into consideration in order to avoid all risks of harm to persons or damage to the appliance.
- The symbol  indicates useful information.



Warnings

- As part of a continuous improvement process our products may be modified without prior notice.
- Exclusively for use as a circulation/filtration pump for pools only. This pump must not be used for any other purpose.
- The appliance must be installed and serviced by a qualified technician in compliance with the manufacturer's instructions and with applicable National standards. The installer is liable for the installation of the appliance and the compliance with National regulations in matters of installation. Under no circumstances can the manufacturer be held liable in the event of failure to comply with applicable National standards.
- The installer must install a disconnect device which will allow disconnection of all poles of the power supply to the pump. Such means of disconnections must be installed in the fixed wiring to the appliance in accordance with all applicable wiring rules.
- Incorrect installation may cause damage to property or serious injuries (possibly causing death).
- It is important that this appliance is handled by skilled and apt persons (both physically and mentally), with prior knowledge of the usage instructions (by having read this manual). All persons not meeting these criteria must not approach the appliance in order to avoid risk of electrical shock or other hazards which could result in property damage or serious injury, including loss of life.
- If the appliance suffers a malfunction: do not try to repair the appliance yourself, contact your retailer.
- Disconnect all power to the appliance and ensure that the appliance is decommissioned prior to attempting any service. Failure to do so can result in risk of electrical which can cause serious injury or loss of life.
- Before any operations check that:
 - The voltage indicated on the appliance identification plate corresponds to the mains voltage,
 - The power supply is suitable for use with the appliance, and that it has a ground connection.
- Eliminating or shunting one of the safety devices automatically voids the warranty, as does the replacement of parts using parts not originating from our stores.
- Keep the appliance out of the reach of children.
- This pump is compatible with all types of pool water treatment. Please refer to the Zodiac® warranty terms for the detail of admissible water balance values.
- Never run the pump without a water supply, or outside the water (this voids the warranty).



Contents

1. Information before installing	3
1.1 General delivery terms and conditions	3
1.2 Contents	3
1.3 Technical specifications	3
2. Installation	3
2.1 Selection of the location	3
2.2 Installing the appliance	3
2.3 Hydraulic connections	4
2.4 Electric connections	4
3. Use	8
3.1 User interface presentation	8
3.2 Checks before starting up	8
3.3 Start up the appliance	8
3.4 User interface settings and use	9
4. Maintenance	15
4.1 Maintenance instructions	15
4.2 Winterizing	15
4.3 Recycling	15
5. Troubleshooting	15
6. Registering the product	16

 Are available in the appendices at the end of these instructions:

- Dimensions
- Description
- Performance graphs
- EC Declaration of compliance

1. Information before installing

1.1 General delivery terms and conditions

All equipment, even postage and packing paid, travels at the risks and perils of the recipient. Written reserves should be made on the transporter's delivery documents if damage during transport is discovered by the recipient (confirmed by registered letter to the transporter within 48 hours).

1.2 Contents

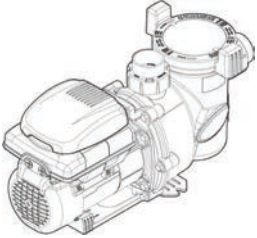
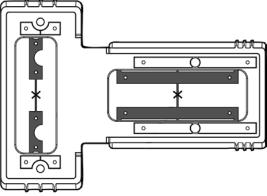
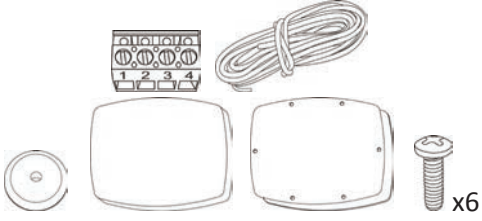
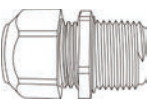
			
FloPro™ VS	Bases	Remote user interface kit	Cable gland
x1	x2	x1	x1

1.3 Technical specifications

- Power: 1.65HP - 1.2kW
- Operation at from 600 to 3450 rpm (settings per 10 rpm step)
- Number of programmable speeds: 8
- Flow rate at 8 metres hydraulic head: 26m³/hr
- Operating temperatures: from 2 to 50°C air, and 2 to 35°C water
- Protection index: IPX4

2. Installation

2.1 Selection of the location

- The pump must be installed:
 - before the filter, the heating system, or the water treatment,
 - at a minimum distance of 3.5 meters from the edge of the pool in order to avoid any projections of spray onto the appliance. Some standards allow for other distances. Refer to the regulations in effect in the country of installation.
 - ideally 30 cm below the water level,
 - outside areas liable to flooding, or on a base with drainage,
 - in a ventilated zone to allow for cooling.
- The pump must not be installed:
 - in an area subjected to water spray, rain, direct sunlight,
 - at more than 3 metres above the water level,
 - close to a heat source or to a source of inflammable gas.
- Install a check valve if the pump is installed above the water level.
- It must have easy access for any work to be carried out on the appliance.
- Use as few bends as possible.

2.2 Installing the appliance

- Install on a stable, solid (concrete slab for example) and level surface.
- If necessary, use the bases provided (one fine + intermediate blocks and one thick, use only one, or both combined) to raise the pump to the level of the existing piping.
- Screw the pump (and the base(s) if applicable) to the ground using suitable lag-screws.

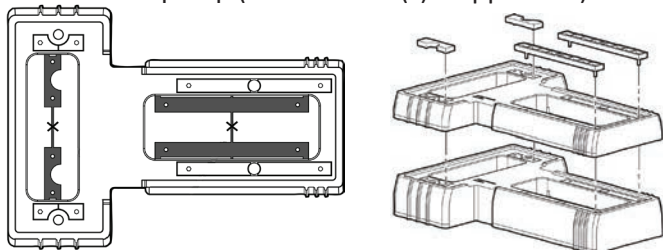

2.3 Hydraulic connections

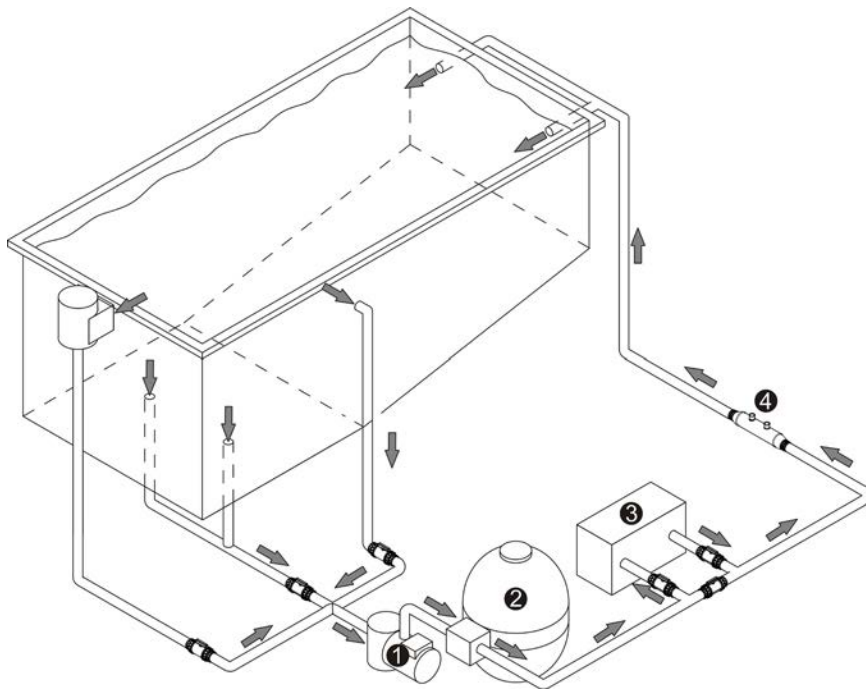

- 1: pump
- 2: filter
- 3: heating system
- 4: water treatment system



Follow the hydraulic connection direction (see § "Sizes" in the appendix).

Pipe	Maximum admission flow rate 1.8 metres/second	Maximum discharge flow rate at 2.4 metres/second
Ø 50 mm	14 m ³ /h	19 m ³ /h
Ø 63 mm	20 m ³ /h	27 m ³ /h

- Choose the piping size depending on the pool size and in compliance with locally applicable hydraulic rules.
- The performance graphs are available in the appendix for use in pipe sizing.
- The use of union fittings on the admission and discharge is recommended to make work on the appliance easier (the pump admission and discharge have a 2" interior threading).
- If more than 10 bends are to be installed on the hydraulic circuit, increase the pipe diameter.
- Avoid high points to facilitate priming.
- Make sure the hydraulic fittings are correctly tightened and that there are no leaks.
- The pipes must be supported to avoid any risk of breakage due to the weight of the water.

2.4 Electric connections

- The pump will only start when commanded by its user interface or an external controller (AquaLink® TRi for example).



- **Risk of electric shocks that can result in serious injury or loss of life. Only a qualified and experienced technician is authorized to wire inside the appliance.**
- **It is imperative to connect the appliance to an earth rod.**
- **Connect the pump so that the general power supply is never inadvertently interrupted when a speed is being used. The speeds are monitored and controlled by the pump user interface and the on-board motor drive controller, not by any other means in the mains power supply (see §3.4.4 for pump timer operation). An improper electric connection voids the warranty.**
- **Loose terminals can cause the terminal block to heat and lead to the warranty being voided.**
- **If the power supply cable is damaged it should be replaced by a qualified technician.**

2.4.1 Voltage and protection

- Electric protection: use a circuit breaker (D curve) or a fuse (aM) (calibre 16A minimum), with a specific 30 mA Residual Current Device (RCD) or Ground Fault Circuit Breaker (GFCB) at the head of the line (circuit breaker or switch).
- The appliance, the pool, and all other electric equipment must be connected to the ground.

i Acceptable voltage variation: +/-10% (when running).

2.4.2 Connecting the motor power supply

- Open the electric box in front of the user interface by removing its screw and lifting it.
- Connect the power supply cable to terminals L1-L2 (or L-N) and \perp (ground).



- Power supply cable size: for a maximum length of 45 metres (calculation on the basis of: 5A/mm²), must be checked and adapted to installation conditions.
- Electrical specifications

Voltage	Full load current		Cable cross section		Electric protection
	A		mm ²	Type	
230V-50Hz	5.22		3x1.5	3G1.5	16

2.4.3 User interface connection options

! In order to avoid risk of electrocution, which can result serious injury or loss of life, be sure to disconnect all power at the source before proceeding with the instructions below.

- Connection to an RS485 terminal block: 1 = red; 2 = black; 3 = yellow; 4 = green
- Do not cut the RS485 cable as this will result in not being able to reconnect the user interface to the pump and will make it impossible to reset the factory settings. The cable is fixed to the pump and cannot be removed or extended.

a) Default connection

- The user interface is fixed and wired to the pump in the factory.
- The pump communicates with its user interface using an RS485 cable (4 wires) (C).

Switch position	1	2	3	4	5
For control using the user interface	on	on	off	off	on

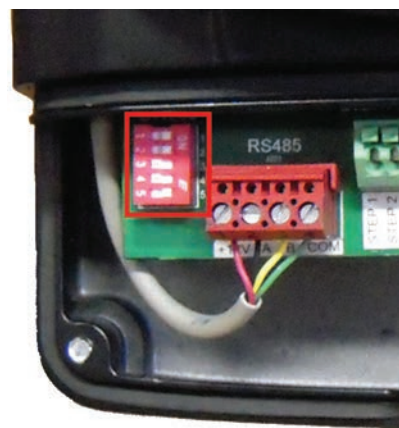

- A: pump electric compartment
- B: pump RS485 terminal block
- C: RS485 pump cable
- D: user interface
- E: user interface terminal block

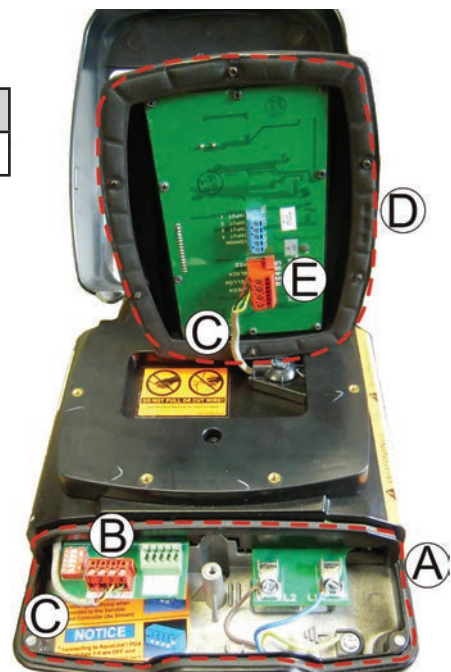
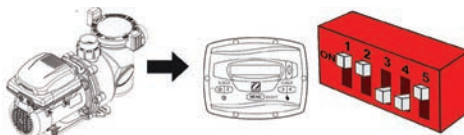

b) Remote user interface option

- This interface can be installed in another location using the supplied remote kit.



- In order to avoid risk of electrocution, which can result serious injury or loss of life, be sure to disconnect all power at the source before proceeding with the instructions below.
- Connection to an RS485 terminal block: 1 = red; 2 = black; 3 = yellow; 4 = green
- Do not cut the RS485 cable as this will result in not being able to reconnect the user interface to the pump and will make it impossible to reset the factory settings. The cable is fixed to the pump and cannot be removed or extended.
- Never lay these low-voltage cables in the same pipe as high-voltage cables.

Pump description:

A: pump electric compartment

B: pump RS485 terminal block





C: pump RS485 cable

D: user interface

E: user interface RS485 terminal block

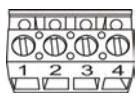
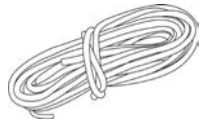
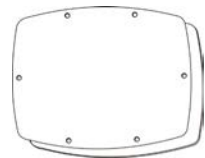
L: removable cap for the cable pass-thru location

Kit contents:

					
Kit RS485 terminal block	Kit RS485 extension cable	Pump base + foam seal	Screws	User interface base	Grommet
F	G	H	I	J	K

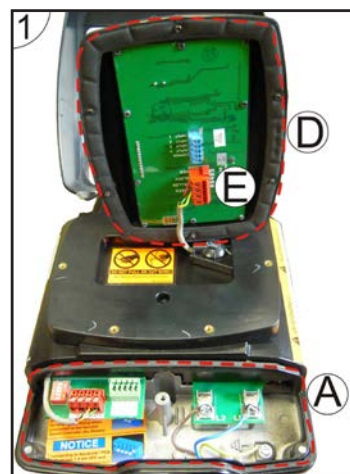

Step 1:

- Open the electric compartment (A) in front of the user interface (D) by removing its screw and lifting the cover.
- Unscrew the 6 screws that hold the interface (D) to the pump.
- Unscrew the 4 wires from the user interface terminal block (E).

Step 2:

- Disconnect the RS485 terminal block (B) and put it aside.
- Unscrew the cap (L) and install a cable gland (not supplied) to take the cable RS485 (G) out of the electric compartment.
- Plan the correct length of cable for the extension (G) and connect it to the RS485 terminal block (F), then connect to the electric compartment (A).

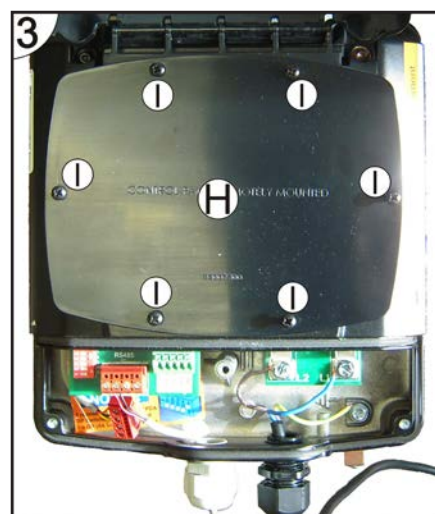
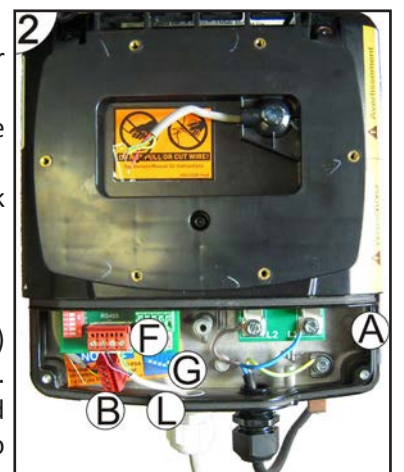

Step 3:

- Fit the base and the foam seal (H) on the user interface location on the pump using the 6 screws (I).

Step 4:

- Drill a hole at the position marked in the centre of the base (J) and install the grommet (K).
- Attach the base (J) onto a stable wall (using screws adapted to suit the base, not included), away from humidity and direct sunlight.
- Connect the other end of the RS485 cable (G) to the user interface terminal block (E).
- Attach the user interface (D) to the base (J) using its 6 screws.

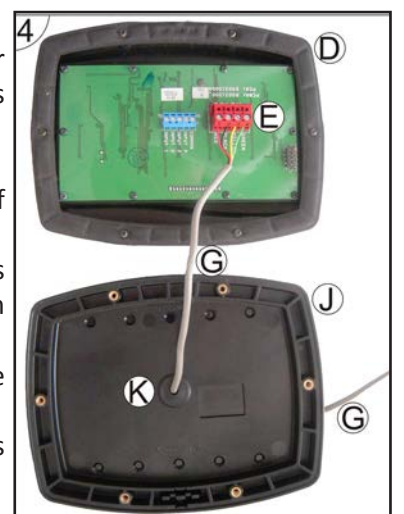

c) AquaLink® TRi connection option



- In order to avoid risk of electrocution, which can result serious injury or loss of life, be sure to disconnect all power at the source before proceeding with the instructions below.
- Connection to an RS485 terminal block: 1 = red; 2 = black; 3 = yellow; 4 = green
- Do not cut the RS485 cable as this will result in not being able to reconnect the user interface to the pump and will make it impossible to reset the factory settings. The cable is fixed to the pump and cannot be removed or extended.
- Never lay these low-voltage cables in the same pipe as high-voltage cables.

- Open the electric compartment in front of the user interface by removing its screw and lifting the cover.
- Disconnect the RS485 terminal block and put it aside.
- Connect the supplied RS485 cable extension between the AquaLink® TRi and the pump using the RS485 terminal blocks.

Switch position	1	2	3	4	5
For control using the AquaLink® TRi	off	off	off	off	on



- Refer to the AquaLink® TRi installation and user manuals to declare the pump and launch it.



The user interface is deactivated when the pump is connected to the AquaLink® TRi.

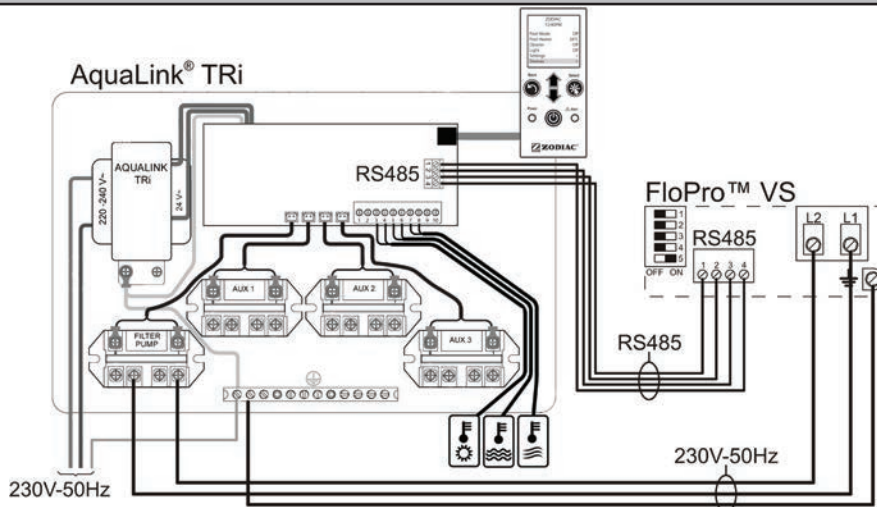

2.4.4 External “on/off” switch connection option

- You can connect to an external dry contact (B) to activate or deactivate a speed n in the case of a backwash or the use of a booster pump.



To connect this function the user interface must be remote in order to pass the wire through the base cable pass-thru (see procedure §2.4.3.b).

In the case of connection to an external controller, the function will be proposed automatically.

- Access the electronic card on the back of the user interface (A).
- Connect the contact to the 2 terminals on the J3 connector: COMMON + INPUT1, 2, 3 or 4 depending on the speed you require to activated using the contact (INPUT1 = speed 1, INPUT 2 = speed 2, INPUT3 = speed 3, INPUT4 = speed 4).

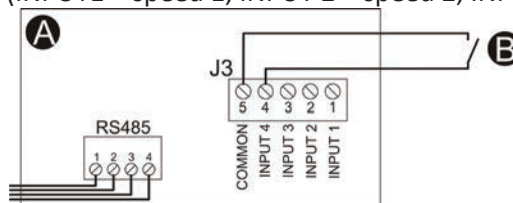

REMOTE ENABLED
12 : 30 PM RPM : 1200 ↓





- When the contact is closed, the regulation interface will display: 12 : 30 PM RPM : 1200 ↓ and the pump will start at the speed selected on the J3 connector.
- Speed 4, by default known as «booster pump», is equipped with a 30-minute timer. When the contact is opened, a

countdown is displayed:

* PUMP WILL REMAIN *
* ON FOR 29 : 30 *

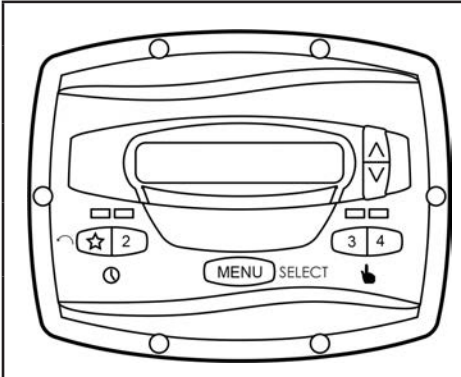
3. Use

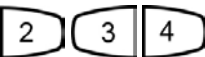
3.1 User interface presentation

	Symbol	Description
		Menu access button Validate a selection
		Preset “eStar” speed button (1750 rpm) Back button for a sub-menu
		Preset speed buttons
		Rotation speed change buttons Menu navigation key (pressing continuously scrolls the values increasingly quickly)

Display: pump off

Time →

P R E S S	S P E E D	O R	M E N U
1 2 : 3 0 P M	P U M P	I S	O F F



← Operation to carry out to activate a speed
← Pump status

Display: pump on

Time →

1 2 : 3 0 P M	2 : S P E E D	2
	R P M : 1 2 0 0	↑ ↓

← Name of the active speed
← Pump speed

i RPM = rotations per minute
 ↑ ↓ = indicates that it is possible to increase or lower the speed in steps of 10 using the  and  keys.
 If the language displayed on the screen are not appropriate, see §3.4.3.d.

3.2 Checks before starting up

- Check that the hydraulic connections have been correctly tightened.
- Make sure the pump is stable, it must be level and flat.
- The electric cable must be routed away from sharp or hot items that could damage it.
- The plumbing system must be drained and must not contain any debris.
- The pump basket cover must be correctly closed (manually) and its seal must be clean and in place.
- Make sure the valves are open.

!

- In order to prevent risk of explosion which can cause property damage and serious injury, including loss of life, ensure that the plumbing system is cleared of any debris or blockages and is not subjected to excess pressures.
- Never run the pump “dry”, as this could risk damaging it.
- The basket cover must be closed manually (do not use tools).

3.3 Start up the appliance

- Start a speed, the pump always starts in “priming” mode (high speed).
- The pump is self priming. However, it is strongly recommended to fill the basket with water before starting up for the first time to facilitate the procedure.
- Purge any air that may be present in the filtering circuit using the purge that is normally on the filter (refer to the pool filter manual).
- The default priming speed is 2750 rpm, the mode runs for 3 minutes.
- To change the speed and/or timing, refer to §3.4.5.c.
- Check that there are no leaks on the hydraulic circuit.

i The pump has a priming capacity up to 3 metres above the pool water level (if the hydraulic circuit is perfectly sealed).

3.4 User interface settings and use

The user interface has a battery to keep the time and saved settings in memory when the pump is no longer connected to the electricity supply.

3.4.1 Locking/unlocking the keyboard

Press and for 5 seconds: displays as long as the keyboard is locked. To unlock, press and for 5 seconds, the message disappears.

3.4.2 Starting or stopping a speed

Speed	Keys to start or stop a speed	Default speed
"eStar"speed		1750 rpm
Speed 2		2750 rpm
Speed 3		2750 rpm
Speed 4		2750 rpm
Speed 5, 6, 7 or 8	then or then to validate	2750 rpm

- When the pump is running it displays (speed n° and name, time, operating speed), and a led lights over the key corresponding to the speed.
- For speeds 2, 3, 4, 5, 6, 7 and 8, you can modify the default speed by pressing or when the speed is running (from 600 to 3450 rpm). When a modification is made, it is saved automatically.
- To set the default "eStar"speed, please refer to §3.4.5.d.
- To stop the pump, press the key for the current speed (, , or) , or on (speeds 5, 6, 7 or 8).

3.4.3 User menu

To access the user menu when the pump is stopped, press for 5 seconds:

To scroll through the menu, use the or keys.

To exit the menu, press , or refrain from any action for 1 minute.

a) Set the time

The time must be set to be able to use the "Timer" function.
AM = before noon (ante meridiem)
PM = after noon (post meridiem)

press to access the setting:

press or to set the time (minute by minute), then validate by pressing

.

b) Label speeds

 Used to associate a name with a pre-programmed speed.

SELECT USER SETUP
LABEL SPEED ↓

press  to access the setting :

SELECT SPEED
1 : FILTRATION ↓

select the speed number you want to label using  or , then press 



to validate:

SELECT LABEL TYPE
GENERAL ↓

or

SELECT LABEL TYPE
CUSTOM ↓

The “General” setting proposes a list of pre-defined labels: Filtration, Cleaning, Spa, Spa jets, Heating, Waterfall, Sheer descent (= water blade) or water feature.

The “Custom” setting allows to enter labels. To do this, modify the flashing character using the  or  keys, validate the character and move on to the next by pressing .

The  key is used to go back to the previous character.

To validate the label, the entire line must be filled, then press  to validate.

c) Display lighting

 Used to adjust the screen back-lighting.

SELECT USER SETUP
DISPLAY LIGHT ↓

press  to access the setting:

SELECT DISPLAY LIGHT
2 MIN TIMEOUT ↓

choose the required setting and press  to validate:

2 min timeout	Turns off the back lighting after the user interface has been idle for 2 minutes
Light off	No screen back lighting
Light on	Screen back lighting always on

d) Language

 Used to choose the interface language.

SELECT USER SETUP
LANGUAGE ↓

press  to access the setting:

SELECT LANGUAGE
ENGLISH ↓

choose the required language (French, English, Spanish, Deutsch, Nederlands or Italiano), then press  to validate.

e) Run duration

 Used to determine how long the speed will run for a manual launch (no Timer), only available for speeds 3 and 4.

SELECT USER SETUP
RUN DURATION ↓

press  to access the setting:

SELECT SPEED
4 : CLEANER ↓

choose the required speed and press  to validate:

RUN DURATION
0 : 0 0 ↓

set the operating time using keys  or  (up to 8 hours in 30 minute steps),

validate by pressing .

f) Password protection



Used to protect access to the user menu using a 4 digit password.
This protection will only activate after the user interface has been idle for 10 minutes

SELECT USER SETUP
PASSWORD PROTECT ↕

press **MENU** to access the setting:

PASSWORD PROTECT ?
NO ↕

choose the required function and press **MENU** to validate:

No	No password protection, the user menu remains accessible to the user
Yes	Password protection activated

PASSWORD PROTECT ?
YES ↕



ENTER PASSWORD
1 2 3 4 ↕

Change the flashing number using the **▲** or **▼** keys, validate the number and move to the next by pressing **MENU**.

The **★** key is used to go back to the previous number.

To validate the password, fill in the 4 numbers and press **MENU** to validate:

* PASSWORD *
* ACCEPTED *

SELECT USER SETUP
PASSWORD PROTECT ↕

To deactivate the password, return to the setting by pressing **MENU** to access it:

CHANGE PASSWORD ?
NO ↕

choose the required function and press **MENU** to validate:

No	The password remains unchanged and active
Clear	Deactivates the password
Change	Used to modify the password

3.4.4 Timeclock



"Timers" (= named "Timeclock", used to programme pump starting and stopping times) can be programmed for speed 2 and "eStar".
The "Timers" operate in the same way every day of the week.



In order to prevent the risk of property damage or injury, it's strongly recommended to use "Timers" when the pump is not controlled externally so that the pump does not activate any speeds when power is restored after being interrupted.

To access the "Timeclock" menu, "eStar" or speed 2 must be running (depending on the speed you want to programme):

1 2 : 3 0 PM 2 : SPEED 2
RPM : 1 2 0 0 ↕

Press **MENU**: 2 : SPEED 2
TIMECLOCK ↕

Press **MENU** to activate or deactivate the programming: 2 : SPEED 2
ENABLE ↕, then press **MENU** to validate.

Press **▼** to set the speed starting time 2 : SPEED 2
ON TIME ↕ using keys **▲** or **▼**, then press **MENU** to validate.

Next set the speed stopping time in: 2 : SPEED 2
OFF TIME ↕, then validate by pressing **MENU**.

Press **★** to exit from the menu.

- When the pump is running on a Timer, the led corresponding to the speed lights red and a clock appears on the screen:

```

🕒          2 : S P E E D 2
1 2 : 3 0 P M      R P M : 1 2 0 0 ⬆️⬆️
  
```

- When the pump is not running but a Timer is active, the led corresponding to the speed lights in green.
- 2 Timers can be activated at the same time. The highest speed Timer will have priority.
- The pump can be stopped manually when a Timer is running by pressing the button for the active speed. The Timer will resume its normal activity on the next cycle.
- If the pump is started manually and a Timer is active, it will stop at the end of the programmed Timer.

```

2 : S P E E D 2
          D I S A B L E ⬆️⬆️
  
```

- To deactivate an active Timer, go to `2 : S P E E D 2` `D I S A B L E ⬆️⬆️`, then press **MENU** to validate.

3.4.5 Service menu

To enter the service menu the pump must be stopped.

Press **MENU**, **★** and **4** at the same time for 5 seconds:

```

S E L E C T   S E R V I C E   S E T U P
          L O A D   D E F A U L T S ⬆️⬆️
  
```

To scroll through the menu, use the **▲** or **▼** keys.

To exit the menu, press **★**, or refrain from al action for 1 minute.

a) Load defaults

i Used to reset the factory settings.

Setting	By default	Possible values
“eStar”speed	1750 rpm	from 600 to 3450 rpm, per 10 rpm step
Speed 2, 3, 4, 5, 6, 7 and 8	2750 rpm	
Priming speed	2750 rpm	
Anti-freeze protection time	30 minutes	from 0 to 8 hours, per 30 minute step
Priming time	3 minutes	from 1 to 5 minutes, per 1 minute step

```

S E L E C T   S E R V I C E   S E T U P
          L O A D   D E F A U L T S ⬆️⬆️
  
```

press **MENU** to access the setting:

```

L O A D   D E F A U L T S
          N O ⬆️⬆️
  
```

press **▲** or **▼** to select “yes”, then press **MENU** to validate, your user interface

will have the factory settings.

b) Last fault

i Used to view the 2 last pump faults.

```

S E L E C T   S E R V I C E   S E T U P
          L A S T   F A U L T ⬆️⬆️
  
```

press **MENU** to access the setting:

```

* - - - - - *
* - - - - - *
  
```

The screen will display the latest error messages. If there are none in memory *-----* will be displayed.

To delete the messages, press **▲** or **▼**.

c) Priming



Used to set the pump priming speed.

A priming speed greater than 2500 rpm is strongly recommended in order for it to be effective.

```
SELECT SERVICE SETUP
PRIMING
```

press **MENU** to access the setting:

```
PRIMING
PRIMING SPEED
```

press **MENU** to change the priming speed:

```
PRIMING SPEED
RPM : 2750
```

use the **▲** or **▼** keys to set the speed (from 600 to 3450 rpm, per 10 rpm step),

then press **MENU** to validate.

```
PRIMING
PRIMING DURATION
```

Press **▲** or **▼** to access the setting press **MENU** to modify the priming time:

```
PRIMING DURATION
MIN : 3
```

use keys **▲** or **▼** to set the time (from 1 to 5 minutes, per 1 minute step), then

press **MENU** to validate.

```
1 2 : 3 0 PM      2 : SPEED 2
PRIMING
```

```
1 2 : 3 0 PM      2 : SPEED 2
RPM : 2750
```

The user interface displays:

when the pump is in the priming cycle.

d) Set "eStar" speed



Used to define the pre-set "eStar" speed (by default known as «1: Filtration»).

```
SELECT SERVICE SETUP
SET ESTAR SPEED
```

press **MENU** to access the setting:

```
1 : FILTRATION
RPM : 1750
```

use the **▲** or **▼** keys to set the speed (from 600 to 3450 rpm, per 10 rpm step),

then press **MENU** to validate.

e) Pump freeze protect



The pump measures the running motor temperature and estimates the water temperature.

It activates the "eStar" speed if the temperature is too low, to protect the pump from freezing. This setting is used to set the anti-freeze cycle time.



Freeze protection is intended to protect equipment and plumbing for short periods of freezing only. It does this by activating the filtration pump and circulating the water to prevent freezing inside equipment or plumbing. Freeze protection does not guarantee that equipment will not be damaged by extended periods of freezing temperatures or power outages. In these conditions, the pool should be shut down completely (for example, drained of water and closed for the winter) until warmer weather exists.

The pump must be protected and properly winterized when freezing temperatures are expected. Allowing the pump to freeze will cause severe damage and will void the warranty.

```
SELECT SERVICE SETUP
PUMP FREEZE PROTECT
```

press **MENU** to access the setting:

```
* PUMP FRZ PROTECT *
0 : 3 0
```

use the **▲** or **▼** keys to set the time (from 0 minutes to 8 hours, per 30 minute

step, then press **MENU** to validate.

To deactivate the function, set the time to "0:00".

f) Pump type

 This setting is used to determine the maximum authorised pump speed depending on the selected type. It is recommended not to change this setting to keep optimum pump performances.

```
SELECT SERVICE SETUP
      PUMP TYPE ↓
```

press **MENU** to access the setting:

```
PUMP TYPE
      e PUMP 60 Hz ↓
```

use the **▲** or **▼** keys to select “ePUMP 60Hz” (maximum speed by default = 3450 rpm) or “ePUMP 50Hz” (maximum speed by default = 2850 rpm), then press **MENU** to validate.

g) Display power usage

 You can display the pump’s electricity consumption while running (in Watts). This setting is only displayed on the screen when the pump is running.

```
SELECT SERVICE SETUP
DISPLAY POWER USAGE ↓
```

press **MENU** to access the setting:

```
DISPLAY POWER USAGE
      NO ↓
```

use keys **▲** or **▼** to select “YES” or “NO” then press **MENU** to validate.

To deactivate the function press “NO”.

When the function is active, the user interface alternatively displays:

```
2 : S P E E D 2
1 2 : 3 0 P M      P W R : 5 8 W
```

```
2 : S P E E D 2
R P M : 1 0 0 0 ↓
```

EN

h) Set minimum limit

 This is used to limit the pump’s minimum operating speed. The user will no longer be able to set the pre-defined speeds 2, 3, 4, 5, 6, 7 and 8 slower than this speed. The default speed is 600 rpm.

```
SELECT SERVICE SETUP
      SET MIN LIMIT ↓
```

press **MENU** to access the setting:

```
SET MIN LIMIT
      R P M : 6 0 0 ↓
```

use the **▲** or **▼** keys to set the speed (from 600 to 3450 rpm, per 10 rpm step), then press **MENU** to validate.

i) Set maximum limit

 This is used to limit the pump’s maximum operating speed. The user will no longer be able to set the pre-defined speeds 2, 3, 4, 5, 6, 7 and 8 faster than this speed. The default speed is 3450 rpm.

```
SELECT SERVICE SETUP
      SET MAX LIMIT ↓
```

press **MENU** to access the setting:

```
SET MAX LIMIT
      R P M : 3 4 5 0 ↓
```

use the **▲** or **▼** keys to set the speed (from 600 to 3450 rpm, per 10 rpm step), then press **MENU** to validate.

4. Maintenance

4.1 Maintenance instructions



It is recommended to carry out general servicing of the appliance on winterizing and restarting in order to check it is in good working order and maintain its performances, as well as to prevent certain possible defects. These actions are the user's responsibility and must be carried out by a qualified technician.

- Make sure no foreign bodies enter the pump or the electric compartment.
- Clean the outside of the appliance, do not use solvent based products.
- Check that the use interface is in working order.
- Check that metal casing is connected to the ground.
- Check the tightness of the electric wire connections and the cleanliness of the electric control box.
- Clean the basket, the lid and its seal regularly.
- Make sure the basket is correctly fitted, otherwise it could prevent the hermetic closure of the lid.

4.2 Winterizing



Freeze protection is intended to protect equipment and plumbing for short periods of freezing only. It does this by activating the filtration pump and circulating the water to prevent freezing inside equipment or plumbing. Freeze protection does not guarantee that equipment will not be damaged by extended periods of freezing temperatures or power outages. In these conditions, the pool should be shut down completely (for example, drained of water and closed for the winter) until warmer weather exists.

The pump must be protected and properly winterized when freezing temperatures are expected. Allowing the pump to freeze will cause severe damage and will void the warranty. To avoid condensation damaging the appliance, do not cover it hermetically.

- If the pump is located beneath the water level, shut off the isolation valves on the admission and discharge.
- Drain the pump (using the 2 drainage screws) and the hydraulic circuit by following the pool manufacturer's instructions.
- Remove the 2 drainage screws and put them aside to be refitted when the pool is restarted.
- It is recommended to disconnect the electric power cable, and then to unscrew the hydraulic fittings to store the pump in a dry location protected from freezing.

4.3 Recycling



This symbol means that your appliance must not be disposed of as household waste. It will be selectively collected with a view to its reuse, recycling or the sale of the parts. If it contains substances potentially dangerous to the environment, these will be eliminated or neutralised.

Ask your retailer for information about recycling.

5. Troubleshooting

Malfunction	Possible causes	Solutions
The water is not circulating properly	<ul style="list-style-type: none"> • Dirty basket and/or filter • Incorrectly set valves 	<ul style="list-style-type: none"> • Clean the basket and/or filter • Adjust the valves
There are air bubbles in the basket	<ul style="list-style-type: none"> • Air is blocked in the circuit • The pool water level is too low • The pump lid is incorrectly sealed 	<ul style="list-style-type: none"> • Purge the circuit • Check the water level, add water if necessary • Check the cover and seal are airtight
There are air intakes	<ul style="list-style-type: none"> • The fittings are not properly tightened • The fitting seals are incorrectly positioned or damaged 	<ul style="list-style-type: none"> • Tighten the fittings • Change the seals
There is no air in the circuit but the pressure is low	<ul style="list-style-type: none"> • There is debris stuck inside the pump 	<ul style="list-style-type: none"> • Remove the debris manually by opening the lid and removing the basket • If debris remains, the pump will need to be dismantled to access the impeller • Warning: these operations must be carried out by a qualified technician
If there is no debris in the pump but the pressure is low	<ul style="list-style-type: none"> • The pump impeller and diffuser are worn • Electric problem • Worn seal 	<ul style="list-style-type: none"> • Have the impeller and diffuser replaced by a qualified technician • Have the electric installation checked by a qualified technician • Replace the seal
There is a water leak between the motor and the pump body	<ul style="list-style-type: none"> • The mechanical packing is damaged or defective 	<ul style="list-style-type: none"> • Replace the mechanical packing • Warning: these operations must be carried out by a qualified technician

Malfunction	Possible causes	Solutions
The pump heats and sometimes switches off	<ul style="list-style-type: none"> • Bad air circulation around the motor • Bad electric connections • Current variations are too high 	<ul style="list-style-type: none"> • Check that the motor is correctly ventilated for cooling • Check the electric connections • Have the electric circuit checked by a qualified technician
The pump will not start	<ul style="list-style-type: none"> • There is no power supply to the pump • The user interface cable is damaged • The pump address is incorrectly configured • The user interface displays an error message 	<ul style="list-style-type: none"> • Check the electric connections • Check the condition of the user interface cable • Check the switch configurations (see §2.4.4)
There is nothing on the user interface or the external controller display	<ul style="list-style-type: none"> • The pump address is incorrectly configured • The user interface cable is damaged 	<ul style="list-style-type: none"> • Check the switch configurations (see §2.4.4) • Check the condition of the user interface cable
The user interface displays "PUMP NOT CONNECTED"	<ul style="list-style-type: none"> • The user interface cable is damaged • The pump address is incorrectly configured 	<ul style="list-style-type: none"> • Check the condition of the user interface cable • Check the switch configurations (see §2.4.4)

6. Registering the product

Register your product on our website: www.zodiac.com

- You will be the first to be informed of new Zodiac® products and special offers,
- You can help us to constantly improve our product quality.



EN

Dimensions

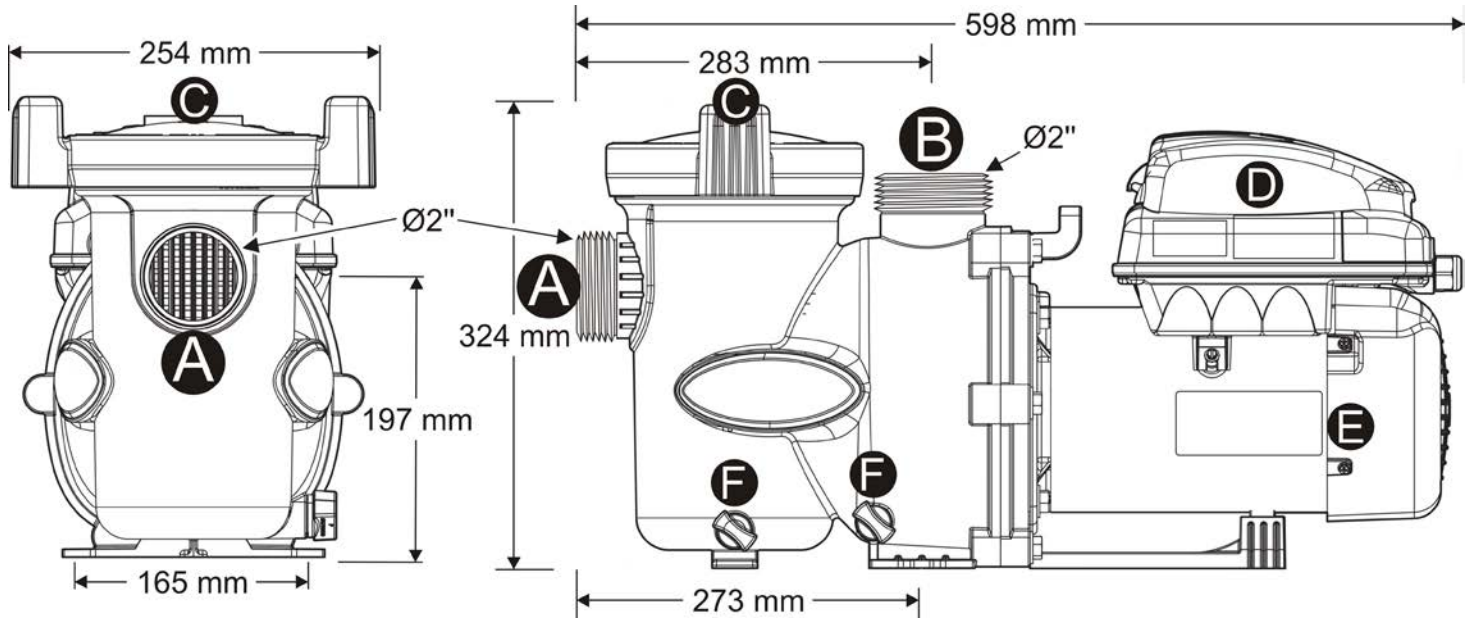

Weight pump only : 17kg

Description

A	Water admission
B	Water discharge
C	Pre-filter cover
D	User interface
E	Pump motor
F	Drain

Performance graphs

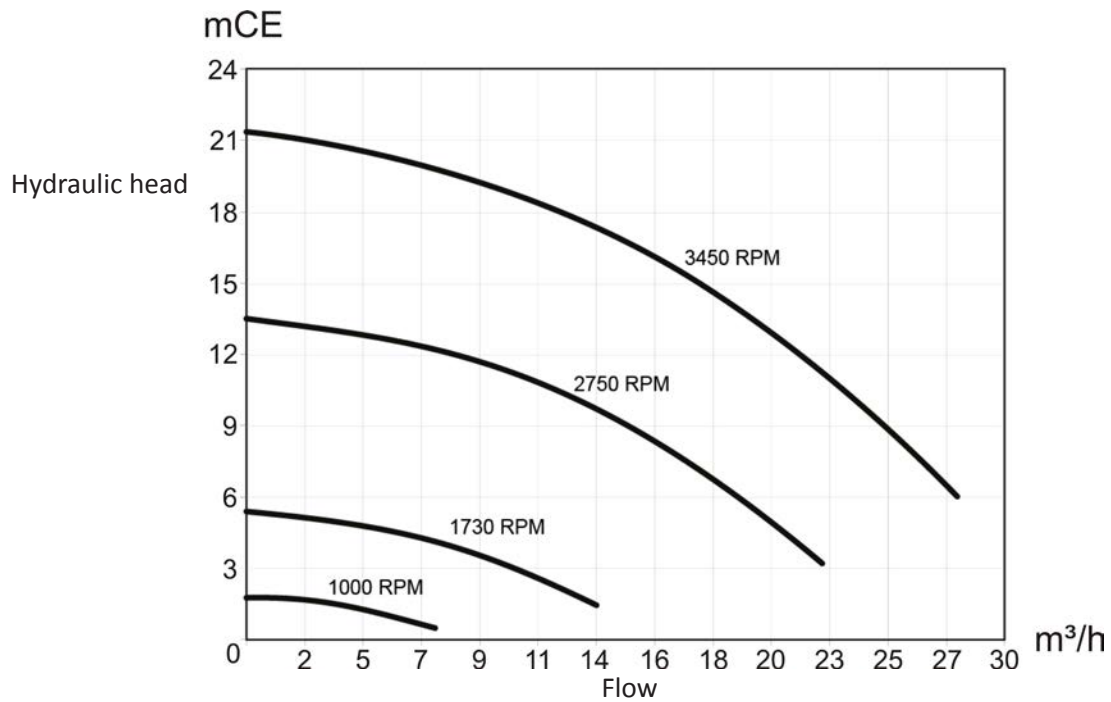

Notes

A series of horizontal dashed lines for writing notes, arranged in a grid pattern across the page.



www.zodiac.com

Pour plus de renseignements, merci de contacter votre revendeur.
For further information, please contact your retailer.

ZODIAC® is a registered trademark of Zodiac International, S.A.S.U., used under license.



Avec Ecofolio
tous les papiers
se recyclent.

Votre revendeur / your retailer