

REACTORS USING MEDIUM PRESSURE
LIGHT
WITH MONITOR MIII



(Picture MP 140)

INSTALLATION AND MAINTENANCE
MANUAL

COMPLIANCE CERTIFICATE

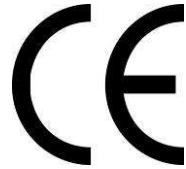

CERTIFICATE OF CONFORMITY

BIO-UV and this subsidiary, hereby declares that the following products

BIO-UV MP Range

comply to the following standards:

NF EN 60439-1 (2000)
CEM: EN55015 (Ed.00) + A1 (Ed.01)

Number and year of EC stamp:

CG-03-006 dated 29/01/2003
LS-03-51003/NL dated 20/02/03

Benoît GILLMANN
Chairman and Managing Director of BIO-UV

A handwritten signature in black ink, appearing to be 'Benoît Gillmann', written over a faint, light-colored signature line.

Société **BIO-UV SA**
ZAC La Petite Camargue
34400 LUNEL France
Hotline: + 33 (0)890 71 03 70 (0,15€/min)
www.bio-uv.com Email: info@bio-uv.com

We thank you for choosing a BIO-UV reactor.

Our equipment has been designed to give you reliable and safe operation for many years to come.

The BIO-UV reactors have been designed for speed and ease of installation.

Their design also makes them easy to maintain..

Read these instructions carefully in order to optimise the operation of your reactor.

<u>CONTENTS :</u>	pages
A. TECHNICAL CHARACTERISTICS	4
B. MAINTENANCE FILE	6
C. WARNINGS AND SAFETY	7
D. INSTALLATION OF THE REACTOR.....	9
E. FLOW SENSOR.....	13
F. MANUAL OF THE MONITOR BIO-UV MIII	14
G. ALARM CONTACT (OPTION).....	17
H. OPERATION OF THE 4-20MA OUTPUT (OPTION).....	17
I. POWER REGULATION OPERATION.....	17
J. CHANGING UV LAMP AND QUARTZ SLEEVE.....	18
K. CHANGING THE WIPER SEALS	22
L. C. SETTING THE ELECTRIC ACTUATOR STOPS.....	22
M. ELECTRICAL UNIT.....	24
N. BLOWN UP VIEW.....	25

ANNEX 1: Clearance dimensions – Blown up view – Designation

ANNEX 2: Electrical diagrams

A. TECHNICAL CHARACTERISTICS

MP RANGE	MP 100 EL	MP 125 EL	MP 140 EL	MP 240 EL	MP 340 EL	MP 440 EL
REACTOR						
Material	Stainless steel 316L					
Finish	Pickling and passivated					
Maximum service pressure	10 bars					
Weight (kg) ⁽¹⁾	40	37	50	55	55	60
Ø and body length (mm)	273 x 1175	273 x 1152	355 x 1244	355 x 1020	355 x 720	355 x 824
Overall length (mm)	1175	1152	1244	1020	720	824
Volume (litres)	45	50	90	85	65	75
Connection type	Flange	Flange	Flange	Flange	Flange	Flange
Standard Connection ⁽²⁾	DN 125	DN 150	DN 200	DN 250	DN 300	DN 300
ELECTRICAL UNIT						
Type	Painted steel					
Dimensions (mm)	600x400 x250	600x400 x250	600x400 x250	600x600x250	800x600x300	800x600x300
Weight (kg)	40	50	70	110	130	150
Power supply	Single phase 230V 50-60HZ	Single phase 230V 50-60HZ	Single phase 230V 50-60HZ	Three- phase 415V Tri+Neutral	Three- phase 415V Tri+Neutral	Three- phase 415V Tri+Neutral
Power supply wiring min	2x1.5mm ²	2x2.5mm ²		4x2.5mm ²		4x6mm ²
Earth cable	6 mm ²					
Differential protection	30mA					
Thermo magnetic protection	10 A	25 A 2P	25 A 2P	25 A 3P	25 A 4P	40 A 4P
Circuit breaker tripping curve	Curve C	Curve D				
Fuse	-					
On / Off switch	Yes					
Power on indicator light	Yes					
UV lamp indicator light	Yes					
Display	Monitor MIII					
Protection index	IP 54					
UV-C LAMP						
Number of lamps	1	1	1	2	3	4
Electrical power	1,000 W	3,000 W	3,000 W	6,000 W	9,000 W	12,000 W
Unit UV-C power	150 W	375 W	475 W	475 W	475 W	475 W
Total UV-C power	150 W	375 W	600 W	1,200 W	1,800 W	2,400 W
Average lifetime	6 to 9,000 h	6 to 9,000 h	6 to 9,000 h	6 to 9,000 h	6 to 9,000 h	6 to 9,000 h

*operating continuously with one on/off per day.



Turning UV lamps on and off reduces their lifespan. A **minimum time delay of 30 minutes** must be observed before turning a lamp back on again.

(1) Caution, with a cleaning system these values change.

(2) Except request specific to the order.



TESTS OF ACCEPTANCE

Client:
Order number:
Unit designation:
Serial number:
Date:

ELECTRICAL SECTION:

Test date:
Wiring carried out by:
Protection classification: IP 54
<u>Observation:</u>

MECHANICAL SECTION :

DESIGNATION	REFERENCE
Quartz	
UVC Lamp	
Quartz joint	
Wiper joint	
Motor / electric jack	
Dimensions between flanges	
Bride	
Reduction	
<u>Checker's name:</u>	<u>Signature:</u>

B. MAINTENANCE FILE



CAUTION:

This sheet must be kept up to date.
It provides a record of the **reactor's operating cycle.**

Date	Action	By

C. WARNINGS AND SAFETY

BIO-UV reactors are ready to install, no works is required inside the reactor.

Read all the instructions in this manual before switching on the BIO-UV appliance.

INSTALLATION

RECOMMANDATIONS

The reactor must be installed:

- in a technical room, protected from light and rain,
- after the filter(s),
- in a dry zone, ambient humidity must be < 80%.

The installation zone temperature must be within 0°C and 40°C.

Keep any sources of hydrochloric acid vapours away from the installation.

The electrical unit should be positioned:

- so that it is protected from water,
- at eye level.

The air vent of fan must not be obstructed.

The cable length between the UV reactor and its electrical unit must not be modified.

Provide for sufficient space for reactor maintenance.

The reactor must be installed so that the UV lamp is in a horizontal position.



- **The equipment must always be filled with water when operating** and the air must be bled out of it.
We recommend the presence of a by-pass.



- **Before accessing the connection terminals, ensure that all supply circuits are disconnected.**
- The reactor installation as a whole must be protected with a **suitably adapted circuit breaker**.
(See A. Technical characteristics)
- Check that cable complies with legislation and the required power level.
(See A. Technical characteristics)
- If, for installation reasons, the power supply cables connecting the cabinet to the reactor have to be shortened, **take care to fully crimp the new end fittings at each end of the cables.**

USE AND MAINTENANCE



- Allow the ultraviolet lamp to cool for at least 30 minutes before handling.

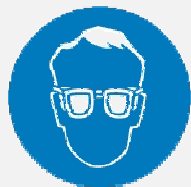

- **Never look at the ultraviolet lamps when lit.** This may cause severe injuries or burns and may even lead to loss of eyesight.



- Do not touch the ultraviolet lamp with bare hands, as these would leave impurities that shorten the life of the lamp. If you do touch it: clean with alcohol or white vinegar.



- Never unscrew the quartz tube sealing nut **when the reactor is on load** as the quartz tube could be blown out of the reactor with force and injure you.

- Do not use the reactor if the **power supply wire is worn or damaged**. In this case it should be replaced.

- If the connecting cable between the reactor and the electrical cabinet is damaged, it must be replaced by a special cable available as a spare part.

- **Even when stopped, power is present in the electrical unit** so make sure that the main power supply upstream of the electrical cabinet is switched off before carrying out any work on the equipment.



- To avoid electric short-circuits, do not place the electric wires or the reactor in the pool water or in any other maintenance or cleaning fluid.

- Do not restart the system until the electric unit, the covers exterior elements of the reactor are correctly back in place.



- Do not use the BIO-UV reactor for any other use than that for which it was designed.

D. INSTALLATION OF THE REACTOR

Wiring of the lamps

The following diagrams give the correspondences for wiring of the lamps according to the unit type.

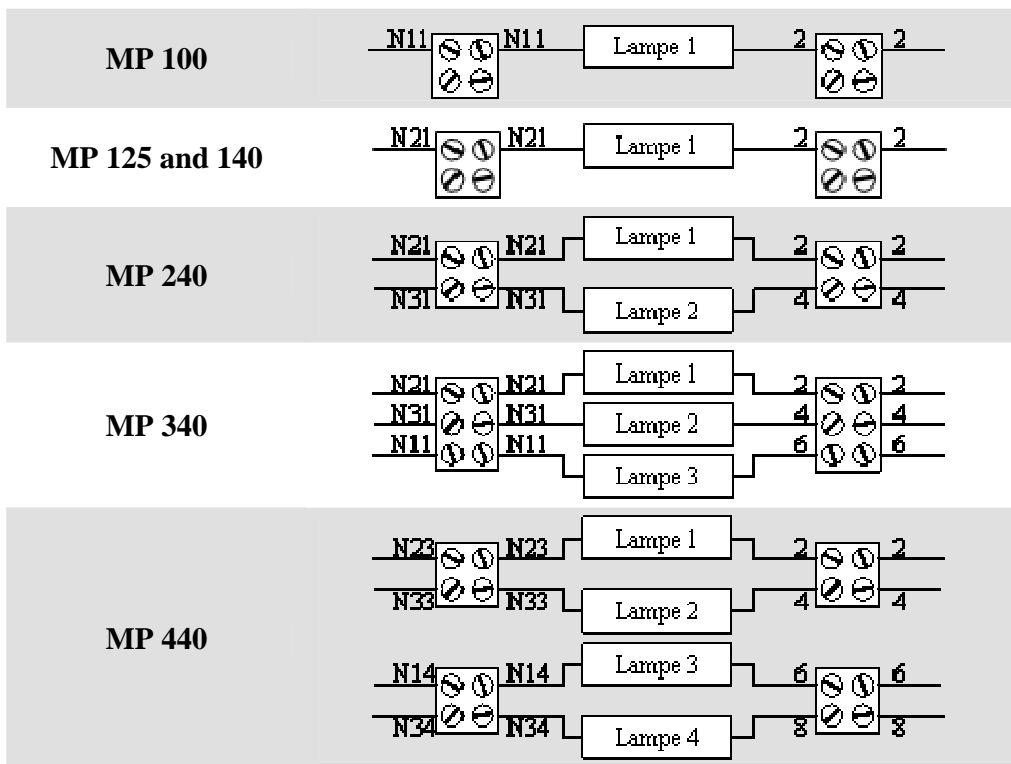

Overall installation view



LAMPS must be HORIZONTAL.

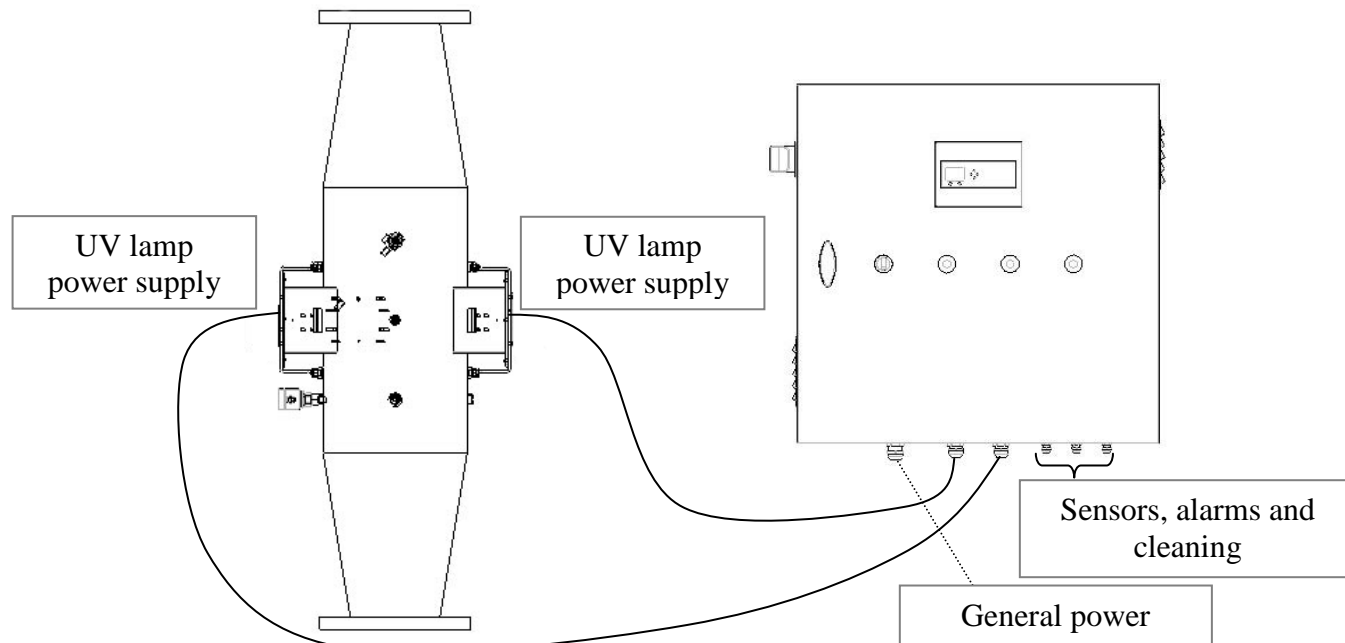



Strictly follow the instructions:

Positioning of reactor

UV SENSOR

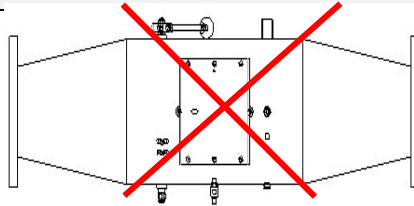
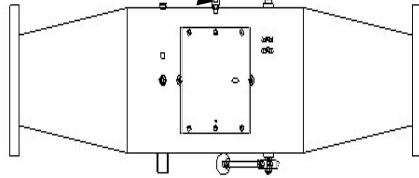

Clearance zone (mm) required to work on the reactor

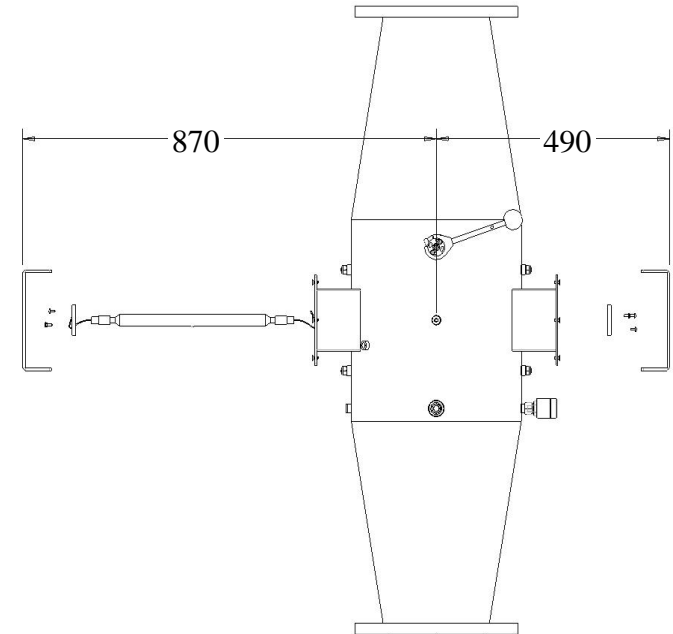

- The water channel is **horizontal**.
- The UV lamps are **horizontal**.

The principal purge is at the base of the reactor.

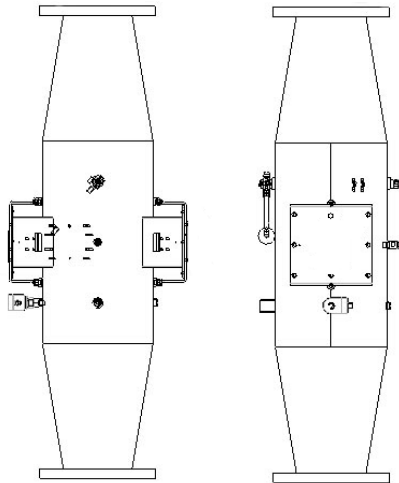

- The water channel is **vertical**
- The UV lamps are **horizontal**.
- The purges are at the base of the reactor.

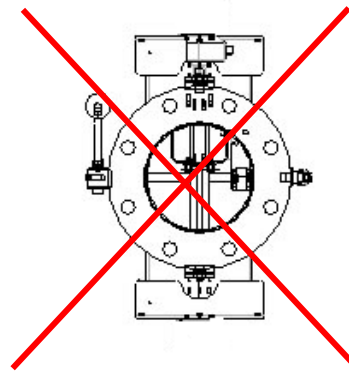

Lamps are in vertical position:
PROHIBITED



THE REACTOR MUST BE PROPERLY CONNECTED TO EARTH AS PER THE DIAGRAM BELOW

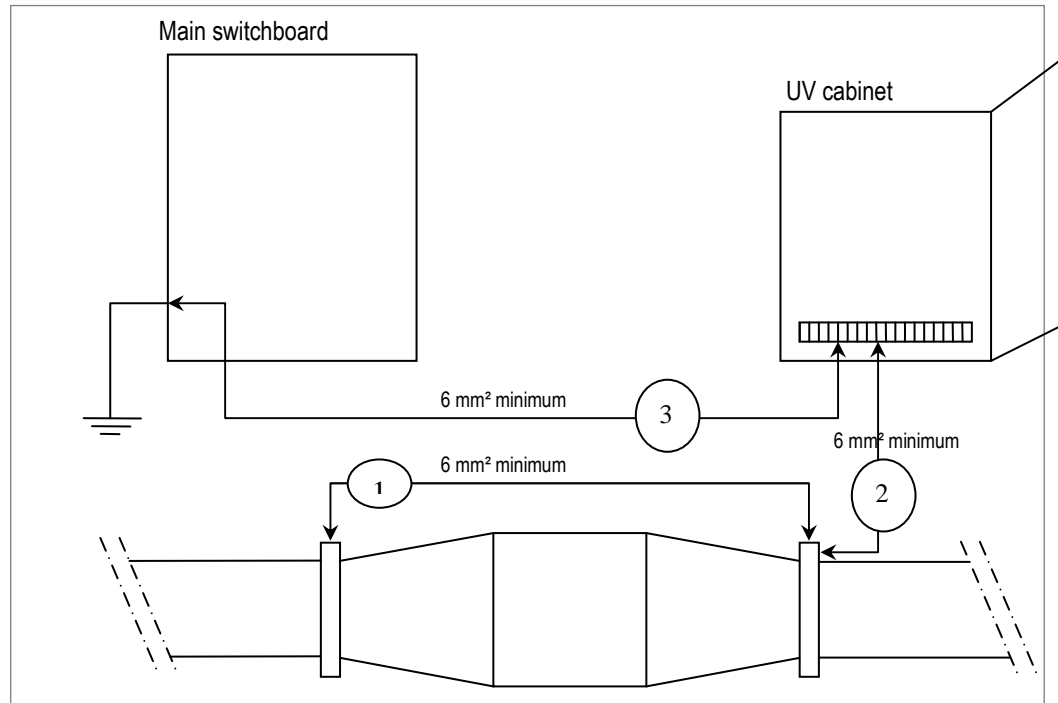

The earth wires marked (1) and (2) are supplied with the UV reactor.

The earth wire marked (3) must be connected when the reactor is installed on site (6 mm² minimum COMPULSORY)



Any earthing fault of the reactor will lead to an exclusion of the guarantee in the event of electrolytic corrosion.

COMPULSORY INSTALLATION INSTRUCTIONS

It is preferable to install the UV reactor in **By-Pass**, and this must **absolutely not be linked to** pump operation.

Instruction No. 1: The UV lamp must be HORIZONTAL whatever the position of the reactor.

Instruction No.2: The reactor must be correctly linked to the earth with a suitable wire of 6 mm² minimum.

Instruction No.3: Fully observe instructions for the removal of lamps and quartz sleeves.

Instruction No.4: The UV sensor MUST be uppermost when the UV reactor is horizontal.

Instruction No.5: If the UV reactor is installed vertically, give preference to the input of water through the bottom of the reactor and make sure that the purge valves are in the lower position.

Instruction No.6: The water flow direction MUST be complied with, as shown by the arrow and "FLOW" on the reactor.

Instruction No.7: Distance chemical products from the reactor to avoid any risk of corrosion.

UV REACTOR COMMISSIONING PROCEDURE

Action No.1: Fill the reactor with water and purge the air.
Check the absence of hydraulic leaks

Action No.2: Verify the correct operation of manual or automatic cleaning

Action No.3: Check the tightness of electrical terminal blocks and connectors

Action No.4: Calibrate the flowmeter

Action No.5: Turn on the lamps and check that they are working

Action No.6: Calibrate the UV sensor after a minimum of five minutes operation (UV lamp heating time)

Action No.7: Calibrate the 4-20 mA output (optional)

Action No.8: Test the correct operation of the flowmeter and the calibration carried out.

Action No.9: Fill in the maintenance sheet page 6



Reminder : If the UV lamps are turned off with the switch or the mains switch,
Wait 30 minutes before turning the UV lamps back on so as to not effect their lifespan.

E. FLOW SENSOR

The flow sensor starts the unit when the flow is present and stops it when the flow rate is insufficient in order to ensure sufficient time for lamp cooling.

The flow sensor is located on the reactor as on this picture:



At the start-up of reactor, it is **NECESSARY** to carry out a calibration on the basis of the **MINIMUM FLOW RATE** in your installation..

Sensor setting to the minimum flow rate:

1. Provide power to the cabinet, **lamp(s) off**
2. Turn filtration on
3. Adjust filtration flow to the minimum (e.g.: By-Pass opening)
4. Press on the ► button of the flow sensor and **hold it down**.
5. The No.9 LED turns on and then flashes after approximately five seconds.
6. Release the button, calibration is finished (**lights 0 to 8 permanently on, No.9 flashes**)

Setting the commutation threshold

To avoid too much stopping / starting of lamps due to fluctuations in flow, the Commutation threshold (red LED) must not exceed No.5, if this is not the case:

1. Press briefly on ◀ or ▶, the red LED flashes
2. Press on ◀ or ▶ as often as necessary to make LED 5 red

The system is now operational. Reset the flow rate to the maximum (close By-Pass). You can switch the lamps on.

Stop filtration to check that the unit stops within a maximum time limit of approximately 60 seconds. (it can only be turned back on after a time delay of 30 minutes).

Correct setting:

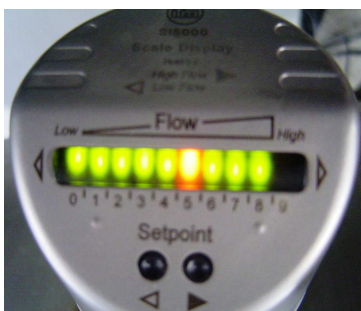

Incorrect settings:



F. MANUAL OF THE MONITOR BIO-UV MIII

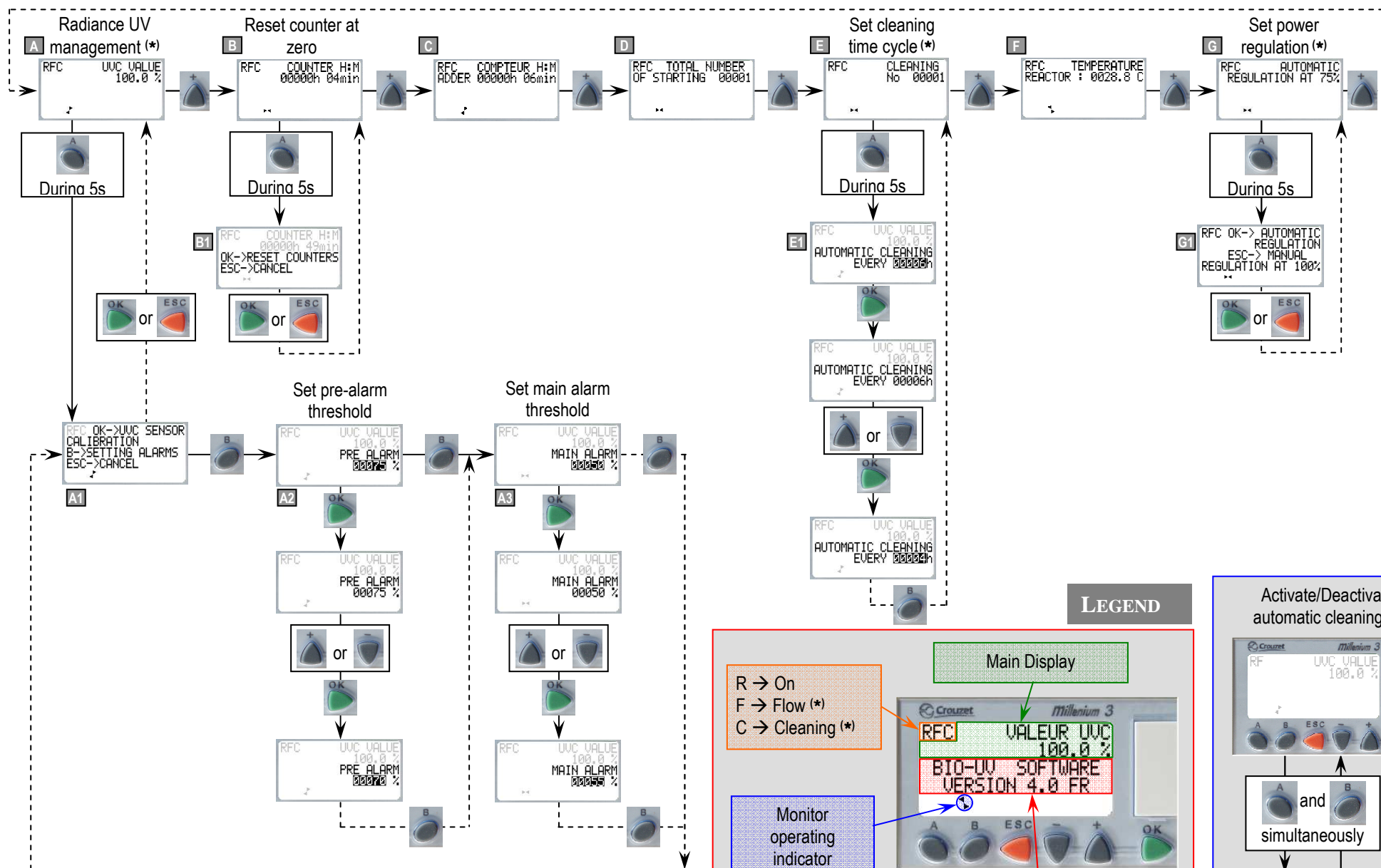

(*) Options according to the reactor

LEGEND

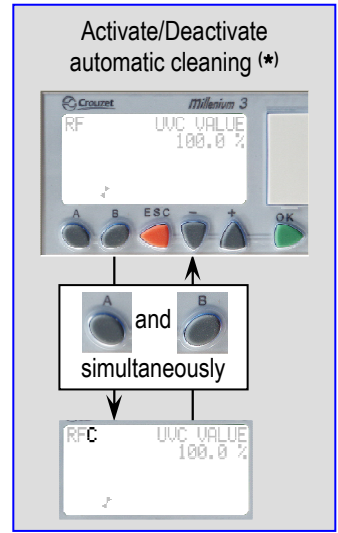
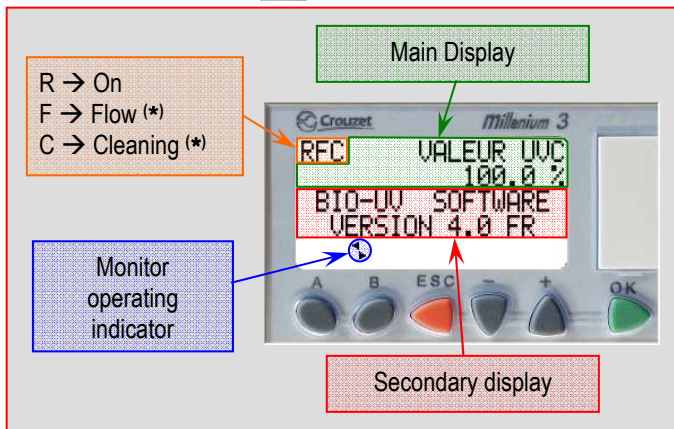

GENERAL INFORMATION:

**This operating manual describes all possible options,
Some of them aren't available on your device according to your reactor type.**

Definition of the 3 letters on the first display	
R	means that the reactor is switched on and operating.
F	means that the water is flowing and that the flow is adequate in relation to the setting that you made on the flowmeter.
C	means that the automatic cleaning function is activated.
Note: for the reactors which don't have a flowmeter, the letter "F" stays always on the display.	

- **The screen is backlit:** Just pressing on a key switches the back lighting on for one minute.
- **Activation/deactivation of automatic cleaning:** Pressing simultaneously on buttons A and B activates or deactivates the automatic cleaning.
- **Caution:** if the cleaning is deactivated when the hydraulic cylinder is operating, the cleaning carriage may stop in the middle of the reactor and block some of the UV rays.

ALERT MESSAGES:

The screen flashes when there is an alert message.

The alert messages are always shown on the secondary display and are independent of what is displayed on the main display unit.

Display	Meaning of the alert	Solutions
	This message appears when the temperature of the cabinet exceeds 60°C. The reactor is stopped automatically.	Check that the cabinet vents are not blocked. Check that the fans are working properly.
	This message appears when the temperature of the reactor exceeds 44.5°C. The lamps are stopped automatically.	Check that enough water is flowing through the installation. If there is a flowmeter, check that is correctly calibrated.
	This message appears when one or several lamps are faulty. The numbers show which of the lamps are faulty.	Diagnose the cause of the breakdown.
	This message appears when the hydraulic cylinder on the automatic cleaning is blocked.	Diagnose the cause of the breakdown.
These 4 alert messages can be cleared by pressing on the key "OK". It is preferable to carry out a maintenance operation before clearing the fault.		
	This message appears when the intensity of the UVC radiation falls below the pre-alarm threshold.	Check that the quartz sleeves are clean. Check that the UV sensor is clean.
N.B.: when the lamps have been operating for a certain number of hours, this message appears naturally (normal wear of the lamps)		
	This message appears when intensity of the UVC radiation falls below the main-alarm threshold.	Check that the quartz sleeves are clean. Check that the UV sensor is clean. Change the UV lamps.
	This message appears when the lamps have been stopped (brought about by a safety device). The lamps will not be relit until after a time delay of 30 minutes. This time delay is to protect the lamps.	
These 3 messages cannot be cleared unless the problem has been resolved.		

CONTENT OF MENUS AND SUB-MENUS:

Use the + or – keys to change from one menu to another.

Press on key A for 5 seconds to enter a menu.

When the word "OFF" is displayed, this means that the display option is not available on your device.



Display of UVC intensity measured by the sensor.

N.B.: each time the lamp is changed, you **MUST** calibrate the sensor **even if the display already shows 100%**.

Calibrating the sensor:



- It is important to carry out this operation when commissioning the reactor and also when changing a lamp **even if the display already shows 100%**.

- It is important to wait 5 minutes before carrying out the calibration, to allow the lamps to heat up.

- If your device is equipped with the power regulator, it is **ESSENTIAL** to switch over to manual regulation (100%) before calibrating the sensor..



Menu for adjusting the pre-alarm threshold. Set in the factory at 75%.

Allows you to set the UVC value at which the pre-alarm will trigger.



Menu for adjusting the main alarm threshold. Set in the factory at 50%.

Allows you to set the UVC value at which the main alarm will trigger.



Display of lamp operating time. It is recommended to reset this counter at zero when you change a lamp.



Reset the hour counter and the number of lamp start-ups at zero.

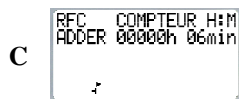

Display the reactor's total operating time since commissioning. This counter cannot be reset at zero..



Display of the number of lamp start-ups carried out. Resetting at zero is linked to that of the hour counter.



Display of the total number of cleaning operations carried out since the reactor was commissioned. This counter cannot be reset at zero.



Adjustment of the frequency of the automatic cleaning cycle. Factory setting: one cleaning cycle every 6 hours. Can be increased to a maximum of one cleaning cycle per hour.



Display of the reactor temperature.



Display of the type of power regulation used.



Power regulation:

Allows you to set the type of power regulation of the UV lamps.

- On automatic regulation, the power switches automatically from 75% to 100% and back depending on the reactor operating conditions.

- On automatic regulation, the lamps are always at 100% power.

G. ALARM CONTACT (OPTION)

The pre-alarm and main-alarm faults are indicated by snap contacts on the monitor which are transmitted to terminal strips (see the wiring diagram in order to identify them).

The snap contacts are normally closed. They open when respective alarms are active.

H. OPERATION OF THE 4-20MA OUTPUT (OPTION)

The 4-20mA adjustment must be realised:

- at the first installation of the reactor,
- at each calibrating of the UV sensor.



The 4-20mA adjustment must be realised only after the UV sensor calibration.
(See Chapter MANUAL OF THE MONITOR BIO-UV MIII)

The 4-20 mA output is the image of the UV-C sensor output not the image of the UV-C % display on the monitor screen.

CALIBRATION OF THE 4-20MA OUTPUT:

1 Before the second step, you must realise the UV-C sensor calibration.

2 Turn the small screw clockwise
until the red LED lighting.

3 The 4-20mA output is calibrated at 100% of UV sensor.

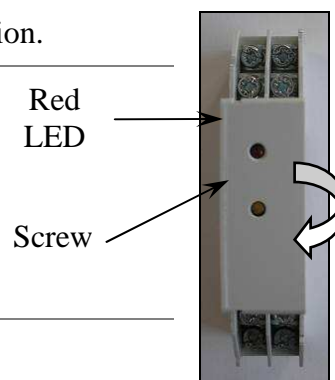

I. POWER REGULATION OPERATION

Equipment fitted with power regulation is designed specifically for your installation to ensure optimum operation even at the end of the lamps' service life:

When the lamp is new and while UV transmission is sufficient (over 70%) it is automatically set at 75% power. When the UV transmission falls below the required level, the power is increased to 100% so as to increase the UV rays transmitted.

This control system is designed to increase lamp life and allow energy savings whilst guaranteeing sufficient UV rays in the long term.

To switch the power regulation on or off, refer to the chapter "Manual of the monitor MIII".

NOTE: When the power regulation device goes into automatic mode, it is necessary to restart the reactor for the change to be taken into account.

J. CHANGING UV LAMP AND QUARTZ SLEEVE

In the event of work on the UV reactor, ensure that personnel are qualified and authorised.

RECOMMENDATIONS FOR VERIFYING OPERATION AND USE

The following points must be **regularly** checked in order to make sure that the UV reactor is operating perfectly:

- **Lamp operation** check: Green light on
- **UV intensity** check: The display on the Millénium III monitor must show a value greater than 50%



In the event of a UV intensity fault (<50%); do not carry out the sensor calibration procedure which must only be carried out with: new lamps(s), clean quartz, clean UV sensor

- Check the operation of the **flowmeter**: In the event of an interruption in flow (backwashing of filters for example), the UV lamps must automatically turn off within 60 seconds, and restart 30 minutes after return to service. (See message on Millenium III display)
- Check the correct operation of electrical cabinet **ventilators** in order to avoid all risk of overheating.
Check that the grills or filters are not obstructed.
- **Activate** the MANUAL cleaning device of the UV reactor **on a daily basis**
(Not applicable in the event of an automatic device: In this case make sure that the latter is working)
- Checked the number of **stop/starts** of lamps on the Millénium III monitor display, which must be coherent with the number and frequency of technical stoppages (filter backwashing, etc).

RECOMMENDED INSPECTIONS AND PREVENTIVE MAINTENANCE

0	Changing UV lamps	At the end of their life span: - either display on the Millénium III monitor: UV intensity <50% - or combined chlorine rate in the basin	
	OPERATIONS	ON EACH UV LAMP CHANGEOVER	AT LEAST ONCE PER YEAR
	Checking the general state of the UV reactor		
1	Replacement of quad ring seals	Compulsory	Compulsory
2	Checking the presence of quartz sheath Teflon shims	Compulsory	
3	Cleaning or replacing the quartz sheath	Compulsory	
4	Replacing the cleaning wipers		Recommended
5	Cleaning the UV sensor	Compulsory	Compulsory
6	Check the operation of the flowmeter	Compulsory	
7	Check the operation of ventilators: - Cleaning grills - Filter replacement (if applicable)	Recommended	Compulsory
8	UV sensor calibration	Only new lamps, quartz sheath clean or new, UV sensor cleaned	
9	Pneumatic silencer replacement	Only in the event of corrosion	
10	Check the earthing of the reactor		
11	Check the operation of the thermostat in the electrical cabinet	Recommended	
12	Check the operation of the circuit breaker	Recommended	
13	Check tightening: - Of terminal blocks in the cabinet - Of connectors - Of UV lamp connections	Recommended	

CHANGING UV LAMP AND QUARTZ SLEEVE

1  **SWITCH OFF the reactor CUT the POWER source and EMPTY IT.**

2  Unscrew and remove the two covers.

3  **Locate the classification of each lamp** in order to rewire the new lamps correctly. (See Wiring of the lamps)

4  Remove the wires from the lamps on both sides by unscrewing the terminals. (only the cables white supplying the lamps).

5  Unscrew the aluminium lamp base, 3 screws, on both sides.

6  Make sure that the UV lamp is cooled before handle it.

7  Remove the UV lamp and place it on a clean and soft surface. **Carry out this operation CAREFULLY** taking care not to place your fingers outside the cap.

8  Unscrew the MP nuts on both sides and remove the aluminium washer.

9  Gently remove the quartz sleeve:

- Push one end of the quartz sleeve in order to pull the other end.
- Remove the quartz sleeve and its seals.

10  **Clean the quartz sleeve** with acid or white vinegar or replace it if necessary.

11  While remaining in the axis, gently reposition the quartz sleeve **in the direction indicated by the label** on the reactor.

12



Centre the quartz sleeve, it should stick out equally on both sides.

13



Change the quartz seals:

(Put new seals at each change of lamp)

- lubricate the seals using food grade grease,
- position them around the sleeve,
- push them fully home in their housing using your nail (help you with aluminium washer).

14



If your reactor is not fitted with a cleaning system:

- replace the aluminium washer,
- replace the MP nuts,
- and go directly to step 17.

15

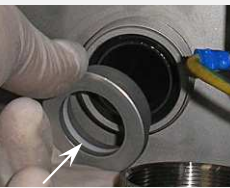

If your reactor is fitted with a cleaning system:

- replace the aluminium washer with them PTFE ring,
- replace the MP nuts.

16

If your reactor is not fitted with PTFE rings, contact your retailer, who will supply the kit PDP003478 and the fitting instructions.

17



Put the installation back in pressure **before** the reassembly of lamps and **check that there is no leakage in the quartz sleeve.**

18

Take hold of the new lamp taking care not to place your fingers outside the cap. (if you do, clean the lamp with a soft cloth and some methylated spirits).

19



Fully engage the lamp in the quartz sleeve.

20



Replace the numbered markings on the new lamp.

21



Replace the aluminium lamp base on both sides.

22



Reconnect the cables to the UV lamp observing with the numbering and the lamp wiring (See Wiring of the lamp).

23



Replace the two covers.

24



Check the calibration of the UV-C ray measurement cell. (See chapter MANUAL OF THE MONITOR)

K. CHANGING THE WIPER SEALS

The wiper seal has two faces, which are easy to identify:

- one has a flat white surface,
- the other has a metal reinforcement.



1



Carry out all the quartz sleeve disassembly operations.

2

Use the handle of manual cleaning to draw the carriage you as far as the mechanical stop.



To do the same thing in case of an automatic cleaning system, disconnect the motor by removing the circlips (see picture).

3

Note the way round that the wiper joint already in place is fitted.

4



Using your index finger, take hold of the wiper seal and disengage it from its housing.
(The wiper seal is flexible, do not hesitate to squash it into an oval shape in order to remove it))

5

Take a new wiper joint.

6



With your index, introduce the new wiper seal into its housing by respecting the direction of assembly.

7

For the 2nd wiper seal, displace the cleaning carriage at the other end.

8

Repeat the wiper seal replacement operations.

9

Repeat the quartz sleeve replacement operations.

L. C.SETTING THE ELECTRIC ACTUATOR STOPS

If the cleaning system's electric actuators are replaced, it is necessary to readjust the actuator stops. This operation is explained in the procedure below.



Note:

The beginning and end of the piston stroke may be adjusted by a maximum of 10mm.

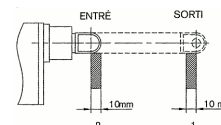

1

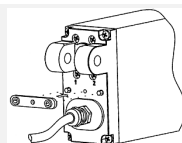

Unscrew and remove the locking bar on the actuator stop set screws.

2



Engage the actuator with the casing on the reactor side (do not close the circlips for the moment).

- 3  Move the arm of the cleaning system by hand to the "retracted" position.
- 4  Assess the distance to be made up between the piston attachment pin and that of the arm.
- 5  Turn end of stroke set screw number 2:
 - In the " + " direction to move the piston into the actuator.
 - In the " - " direction to move the piston out of the actuator.
 One turn of the screw represents approximately a change of 1mm of the piston's stroke.
 Remark: a 6mm allen key is required for this operation (if not use the locking bar).
- 6  Switch the automatic cleaning system off and on from the MIII monitor.
 Wait until the end of the electric actuator cycle and try to attach the piston to the cleaning system arm.
 The attachment of the actuator to the cleaning arm must be carried out easily without forcing it, if this is not the case then repeat the above steps to improve the adjustment
- 7 When the "retracted" position has been adjusted, set the "extended" position:
- 8  Move the arm of the cleaning system by hand to the "extended" position.
- 9  Disconnect the cable "I5" (24Volts dc) from the electric actuator box.
- 10 Switch the automatic cleaning system off and on from the MIII monitor.
- 11 Assess the distance to be made up between the piston attachment pin and that of the arm.
- 12  **If the piston is extended too far**, turn the set screw number 1 in the " - " direction so that the piston is "too far in".
 Reconnect the cable " I5 " to allow the piston the come back to the "retracted" position.
 Then disconnect this cable again and switch on the automatic cleaning from the MIII monitor.
 "Too far out" If the piston is too far in, go to the next step or repeat this step.
- 13  **If the piston is too far in**, turn set screw number 1 in the " + " direction until the Piston/Arm attachments are perfectly aligned.
 → Any movement of the set screw simultaneously moves the piston (only in the "+ » direction)
 "Too far in" The attachment of the actuator to the cleaning arm must be carried out easily without forcing it, if this is not the case then repeat the above steps to improve the adjustment.
- 14  Once the setting of the two stops has been adjusted, **reconnect** the cable " I9 ".
- 15 Fix the electric actuator to the reactor with the circlips and switch the automatic cleaning back on from the monitor MIII to check that the system is operating correctly.

M. ELECTRICAL UNIT

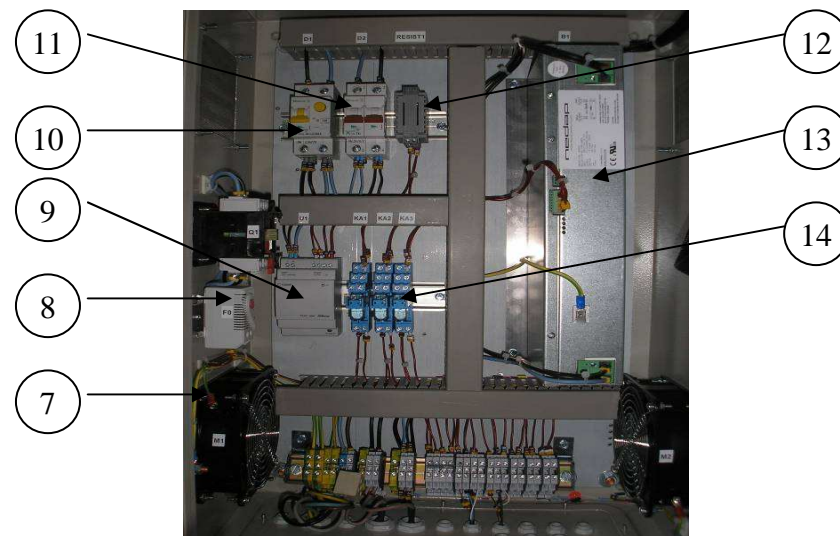
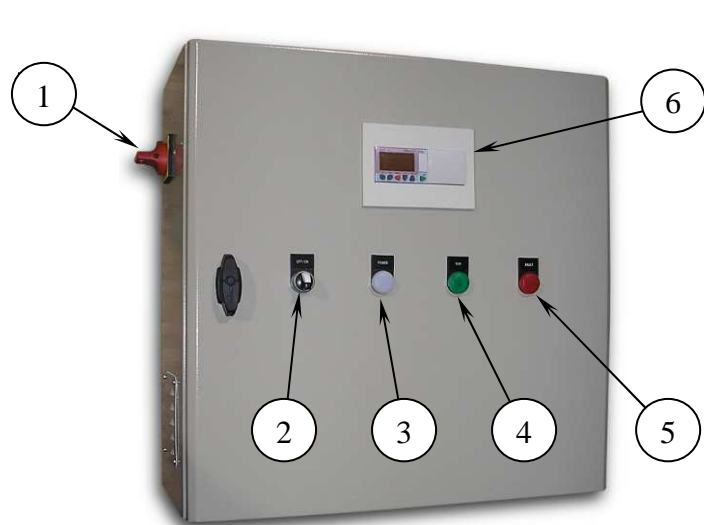

N°	Désignation	Tag	Références and quantities by reactor											
			MP100	Qty	MP125	Qty	MP140	Qty	MP240	Qty	MP340	Qty	MP440	Qty
1	Disconnecting switch	Q1	ELE000117	1	ELE000117	1	ELE000117	1	ELE000112	1	ELE000112	1	ELE000140	1
	Main pole		-		ELE001080	1	ELE001080	1	ELE001082	1	ELE001082	1	ELE001083	1
2	ON/OFF switch	S1	ELE000271	1	ELE000271	1	ELE000271	1	ELE000271	1	ELE000271	1	ELE000271	1
3	Hide lighth white	H1	ELE000297	1	ELE000297	1	ELE000297	1	ELE000297	1	ELE000297	1	ELE000297	1
	LED white		ELE000274	1	ELE000274	1	ELE000274	1	ELE000274	1	ELE000274	1	ELE000274	1
4	Hide lighth green	H2	ELE000296	1	ELE000296	1	ELE000296	1	ELE000296	1	ELE000296	1	ELE000296	1
	LED green		ELE000272	1	ELE000272	1	ELE000272	1	ELE000272	1	ELE000272	1	ELE000272	1
5	Hide lighth red	H3	ELE001016	1	ELE001016	1	ELE001016	1	ELE001016	1	ELE001016	1	ELE001016	1
	LED red		ELE001303	1	ELE001303	1	ELE001303	1	ELE001303	1	ELE001303	1	ELE001303	1
6	Monitor M3	Monitor	ELE002401	1	ELE002401	1	ELE002401	1	ELE002401	1	ELE002401	1	ELE002401	1
7	Fan	M	ELE000189	2	ELE000189	2	ELE000189	2	ELE000189	2	ELE000242	1	ELE000242	2
	Disposable filter		ELE001871	1	ELE001871	2								
8	Thermostat	F0	ELE000335	1	ELE000335	1	ELE000335	1	ELE000335	1	ELE000335	1	ELE000335	1
9	Power supply 24VDC	U1	ELE002161	1	ELE002161	1	ELE002161	1	ELE002161	1	ELE002161	1	ELE002161	1
			ELE002202*		ELE002202*		ELE002202*		ELE002202*		ELE002202*		ELE002202*	
10	Circuit breaker	D1	ELE000186	1	ELE004426	1	ELE004426	1	ELE004499	1	ELE004497	1	ELE004496	1
	Differential		-		-		-		ELE004498	1	ELE004495	1	ELE004495	1
11	Circuit breaker	D2	ELE004425	1	ELE001445	1	ELE001445	1	ELE001445	1	ELE001445	1	ELE002334	1
12	Resistor box	RESIST1												
13	Electronic Ballast	B	BAL004390	1	BAL004270	1	BAL004270	1	BAL004270	2	BAL004270	3	BAL004270	4
14	Relay	KA	ELE001060	3	ELE001060	3	ELE001060	3	ELE001060	3	ELE001060	3	ELE001060	3
				5*		5*		5*		5*		5*		5*

* Only with Automatic cleaning option

N. BLOWN UP VIEW

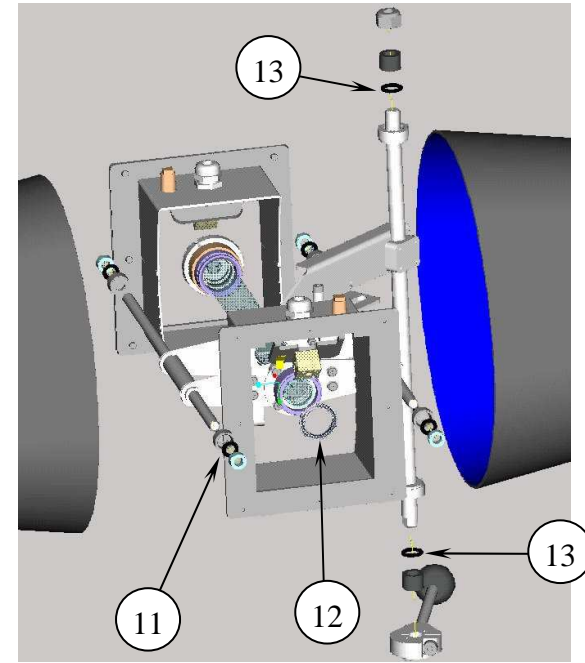
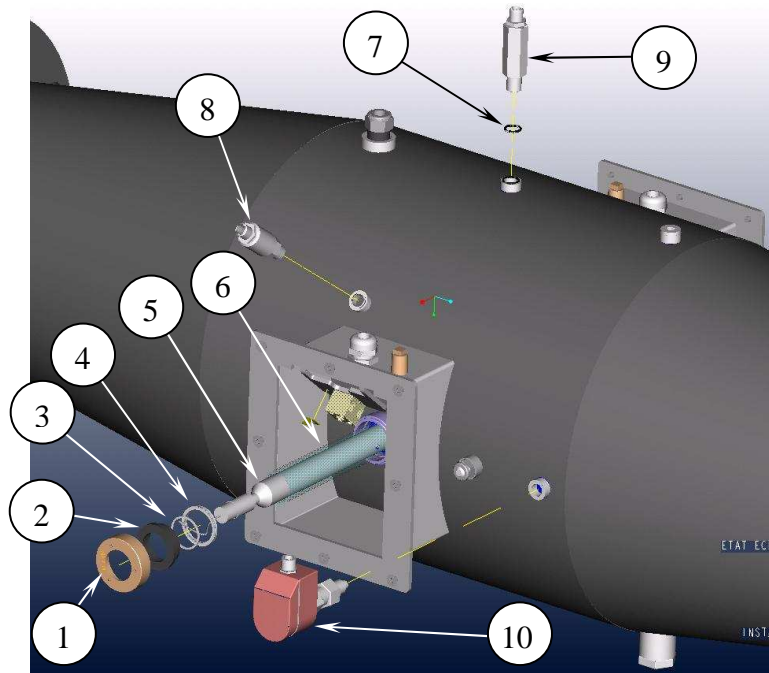

N°	Quantity	Designation * Multiply this number by the number of lamps.	Reference			
			MP 100	MP 125	MP 140 & 240	MP 340 & 440
1	2*	MP nut	USI000019	USI000019	USI000019	USI000019
2	2*	Aluminium washer	PIE000487	PIE000487	PIE000487	PIE000487
3	Variable	PTFE rings kit	PDP003478	PDP003478	PDP003478	PDP003478
4	2*	Seal	JTS000098	JTS000098	JTS000098	JTS000098
5	1*	Lamp	LPE000010	LPE004371	LPE004372	LPE004372
6	1*	Quartz sleeve	QUA000021	QUA000021	QUA000022	QUA000022
7	1	Seal	JTS000230	JTS000230	JTS000230	JTS000230
8	1	Temperature sensor Temperature sensor cable	ELE002289 ELE002701	ELE002289 ELE002701	ELE002289 ELE002701	ELE002289 ELE002701
9	1	Teflon UV sensor for MP UV sensor cable	ELE002288 ELE002800	ELE002288 ELE002800	ELE002288 ELE002800	ELE002288 ELE002800
10	1	Flow meter SI1000 and SI5000 Flow meter SI1006 and SI5006 Flow meter cable SI1000 and SI5000 Flow meter cable SI1006 and SI5006	ELE000057 ELE000056 ELE000306 ELE000016	ELE000057 ELE000056 ELE000306 ELE000016	ELE000057 ELE000056 ELE000306 ELE000016	ELE000057 ELE000056 ELE000306 ELE000016
11	4	Seal 10x3	JTS000094	JTS000094	JTS000094	JTS000094
12	2*	Wiper seal	JTS000099	JTS000099	JTS000099	JTS000099
13	2	Seal	JTS000095	JTS000095	JTS000095	JTS000584
14	2	Exhaust silencer	PNEU000097	PNEU000097	PNEU000097	PNEU000097

WARRANTIES

Units in the BIO-UV range are guaranteed subject to the following conditions:

- **5 years** for the stainless steel reactor (materials and welding) except in the event of use in a highly corrosive environment (brackish or very salty, e.g.: seawater).
- **2 years** for all other components excepting the UV lamp (consumable).

Electrical components are not guaranteed against overvoltage and lightning damage.



Caution: the quartz tube and the lamp are not guaranteed against breakage.

- **Faulty parts must be returned to BIO-UV**, with details of the **unit type** and **serial number**, for exchange after technical evaluation.
- **Shipping costs will be shared** between the retailer and BIO-UV.
- **The guarantee** runs from the day of installation: this date must be notified to BIO-UV by returning the guarantee validation form by post or fax.



Caution: If the guarantee validation form is not returned within one month following purchase of the unit, BIO-UV will use the month and year of manufacture of the unit as the guarantee start date.

- **If the instructions for installation and use are not followed**, BIO-UV cannot accept responsibility and the guarantees will be considered null and void.

How to contact the BIO-UV Team.

Société **BIO-UV SA**
ZAC La Petite Camargue
34400 LUNEL France
Hotline: + 33 (0)890 71 03 70 (0,15€/min)
www.bio-uv.com Email: info@bio-uv.com

ANNEX 1

Clearance dimensions

Blown up view

Designation



ANNEX 2

Electrical diagrams

