

INSTALLATION MANUAL

EN

HANDBUCH

DE

MANUAL DE INSTALACION

ES

MANUEL D' INSTALLATION

FR

MANUALE D' INSTALLAZIONE

IT

PACK CONTENTS

- A) Control device (standard model)
- B) Attachment screw ($\phi=6$ mm)
- C) SRH-1 Rx electrode
- D) 465mV buffer solution
- E) PSS3 probe-socket (1/2" GAS)
- F) Tapping saddle for securing PSS3 onto 2" hose ($\phi=50$ mm)

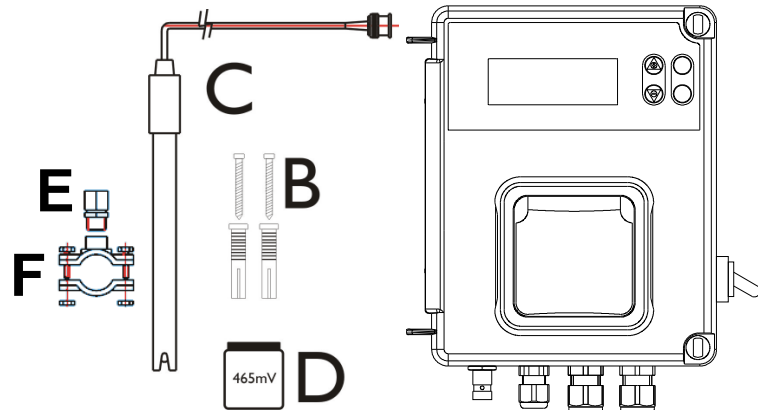

TECHNICAL SPECIFICATIONS

Dimensions (H – W – L)	234x162x108 mm
Weight	1 kg
Power supply 50 Hz	230 VAC
Output system	230 VAC
Consumption	12 W
Measure scale	0 ÷ +1000 mV
Device precision	± 10 mV
Device accuracy	± 2 mV
Electrode regulation	Automatic

Wall Mounting Setup

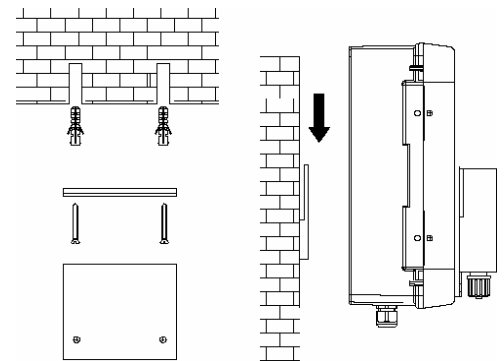

ATTENZIONE / WARNING / ATTENTION / ACHTUNG

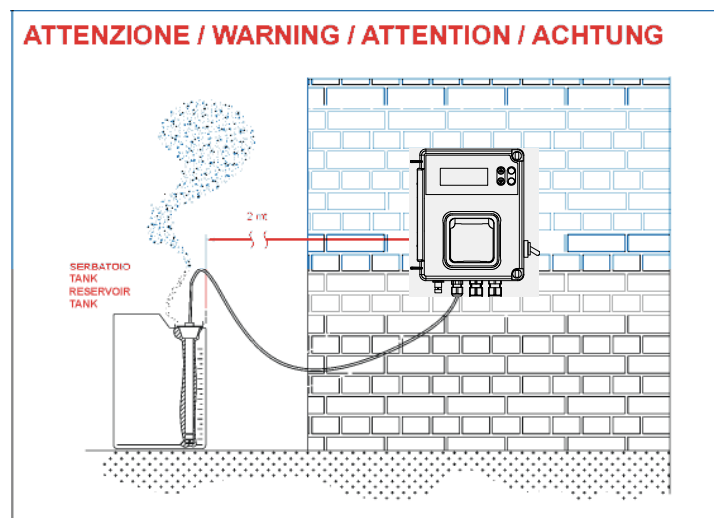



Instruction Setting

Functions:

- **Calibration**

- (Press  for 3 Seconds):
- Standard Routine calibration for 465mV buffer solution

- **Set Point**

- Press  
 - Keep Press Set Key and adjust value with

- **Sp_465mV**

- Press  for 5 Seconds and run Program Setup:

- **Program**

- Press  to set the following Item



- **Language**

- It's possible to have 5 language EN, IT, SP, DE, FR

- **Flow**

- Adjust value with  and 
 - It's possible to enable(ON) or disable (OFF) signal input



- **Setpoint_____680mV**



- Adjust value with  and 



- It's possible to adjust from 0 to 1000 mV .



- **Setpoint_Type__High**



-

- Adjust value  and 
 - It's possible to adjust dosing, High or Low for Redox.

- **OFA_Time_____off**
 - Adjust value  and 
 - It's possible to adjust OFA time in minutes

- **Calibration___465mV**
 - Adjust value  and 
 - It's possible to select 465mV or function disable.

- **Man_Temperature_25°C_**
 - Adjust value  and 

- Save and escape Program setup with ESC key
 - **Exit_____save**
 - Adjust value with  up or down key and confirm with 
 - **Priming**



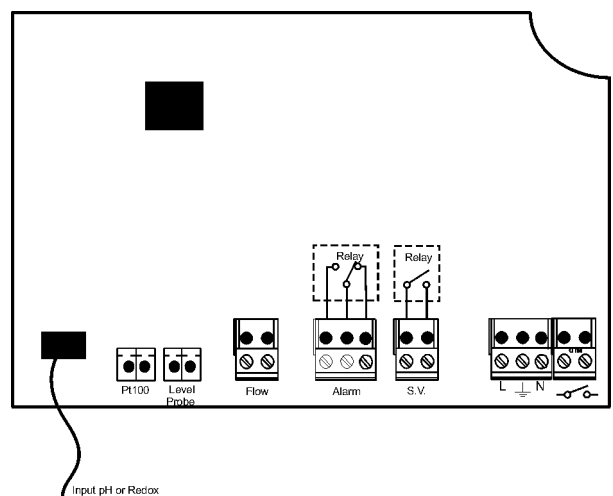

- Priming Pump Keep Press  for 3 seconds

Wire Connection:

- 1) Input Redox Probe
- 2) Input Temperature Probe (PT100)
- 3) Input Level Probe (Product Tank)
- 4) Input Flow Rate (High Voltage 230 Vac)
- 5) Output Relay Alarm remote (Dry contact, Relay 250 Vac 10 A)
- 6) Output Relay Drive Solenoid Valve (Dry contact, Relay 250 Vac 10 A)
- 7) Power Supply 230 Vac
- 8) Switch Power Supply

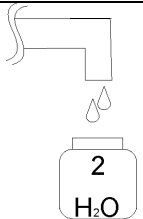
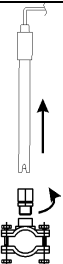
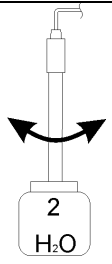
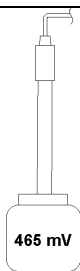

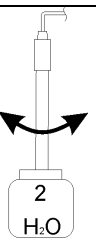
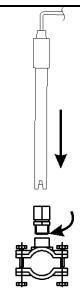
Redox Probe Calibration

<p>①</p> 	<p>②</p> 	<p>③</p>  <p>Wash</p>
<p>④</p>  <p>Keep probe into Buffer solution</p>	<p>⑤</p> <p>Calibration</p>  <p>Press Cal Key 3 Seconds</p>	<p>⑥</p> <p>465mv__Press_CAL</p>  <p>Calibration During 1 minutes</p> <p>Wait_____60s</p>
<p>⑦</p> <p>465mv_Quality_100%</p> <p>Quality Probe</p>	<p>⑧</p> 	<p>⑨</p> 
<p>⑩</p>  <p>Press Cal Key 3 Seconds</p>	<p>⑪</p> <p>Normal Status</p>	

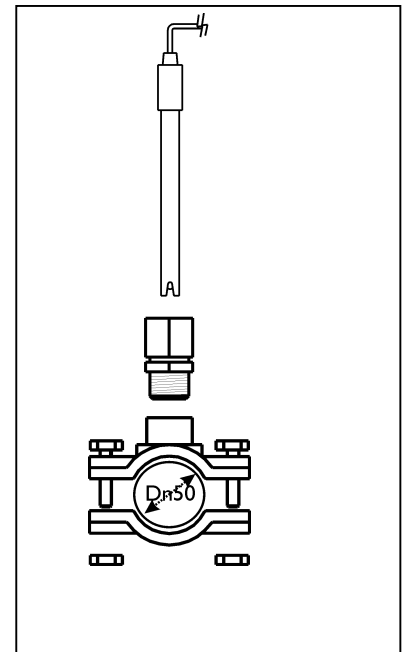
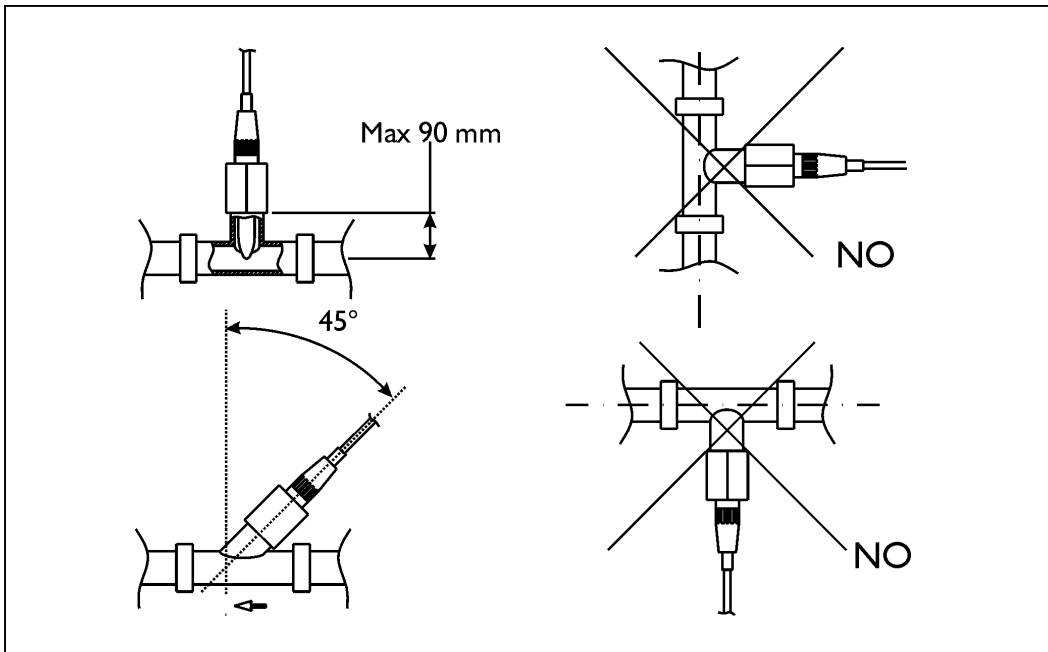

Alarm	Display	Relay	Actions to do
Level	Level ___465_mV	Alarm Relay Close	- Push Enter Key to open Alarm Relay - Restore Product tank
OFA First Alarm (time >70%)	OFA_Alarm_465_mV	Alarm Relay open	- Push Enter Key to reset
OFA Second Alarm (time =100%)	OFA_STOP_465_mV	Alarm Relay Close	- Push Enter Key to reset
Flow Rate	Flow _____465_mV	Alarm Relay open	- Restore Flow Rate
System Error	Parameter_Error	Alarm Relay Open	- Press Enter Key to replace Default parameter - Destroy Unit
Calibration Funciont	Error_465_mV	Alarm Relay open	- Restore Probe or Buffer solution and repeat calibration function

Default parameters:

- Language = **UK**
- Set Point value= **750mV**
- Dosing Method = **Low**
- Time OFA = **OFF**
- Calibration = **465mV**
- Flow Input= **OFF**
-

To restore Default parameters run Following steps:

- Power off Pool Basic unit
- Keeping Press UP and DOWN Key switch on the Power.
- The unit will flash **Init.default__no**
- Press up **Init.default__Yes**
- Enter Key to restore Default parameters.

Verpackungsinhalt

- A) Steuereinheit (Standardmodell)
- B) Schraubendübeln ($\phi = 6$ mm)
- C) 465mV Kit Pufferlösung
- G) SRH-1 Redox-Elektrode
- H) PSS3 Sondenhalter (1/2" GAS)
- I) Montagebügel für PSS3 2" ($\phi=50$ mm)

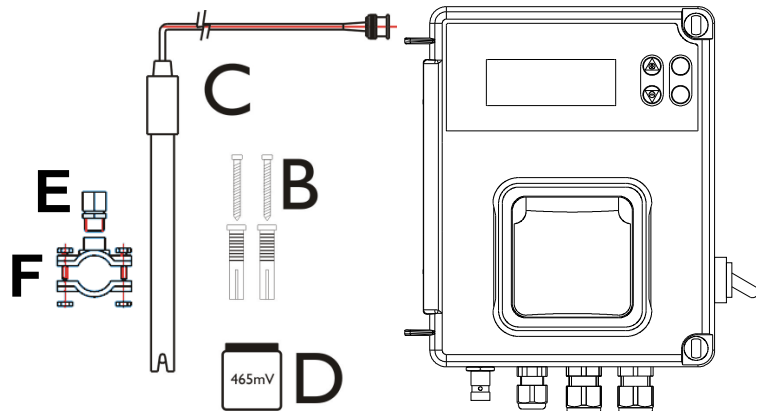

TECHNISCHE DATEN

Abmessungen (H - B - T)
Gewicht
Spannungsversorgung
Verbrauch
Messskala
Messgenauigkeit
Genauigkeit Maß
Kalibrierung der Elektrode

234x162x108 mm
1 kg
230 Vac
12 W
0 ÷ +1000mV
 ± 10 mV
 ± 2 mV
automatisch

Wandmontage

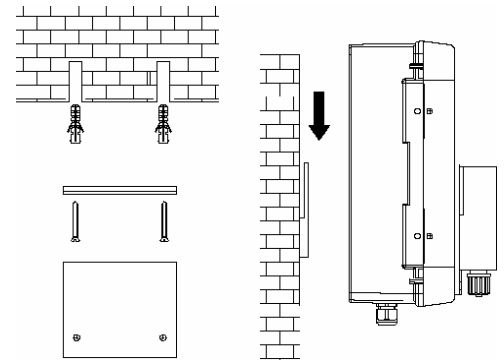

ATTENZIONE / WARNING / ATTENTION / ACHTUNG

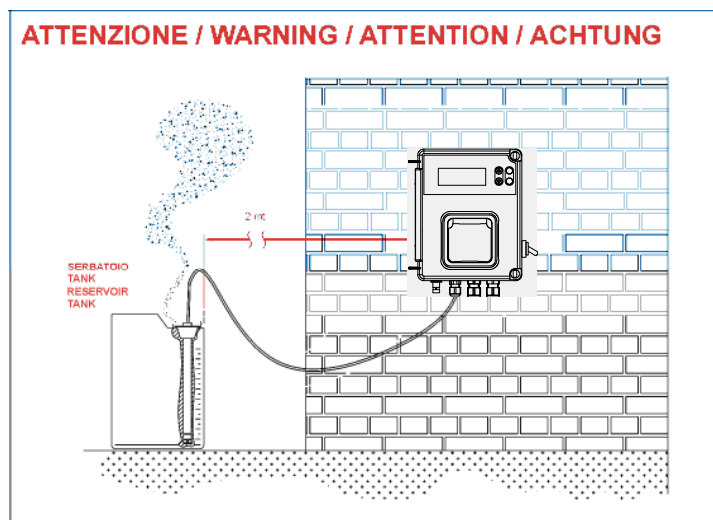



Einstellungen

Funktion:



- **Kalibrierung**

- 3 Sekunden lang die Taste  drücken
 - Standardabfolge der Kalibrierung für Pufferlösung mit 465mV.

- **Set Point**

- Taste  drücken
 - Die Taste Set Key gedrückt halten und den Wert über die Tasten  verändern.

- **Sp_465mV**

- Die Tasten   (zusammen) 5 Sekunden lang gedrückt halten, um in das Konfigurationsmenü zu gelangen:

- **Parameter**

-  drücken, um die folgenden Punkte einzustellen



- **Sprache**

- (Es können 5 Sprachen eingestellt werden EN, IT, SP, DE, FR)



- **Fluss**

- Über die Tasten  auswählen
 - Der Durchflusseingang (Hochspannung), der parallel zur Rückförpumppe angeschlossen ist, kann aktiviert (ON) oder deaktiviert (OFF) werden.



- **Sollwert___465mV**

- Über die Taste  auswählen und über  einstellen)
 - Der Wert kann zwischen 0 und +1000 mV verändert werden.



- **Sollwert_Typ__Saure**

- Über die Taste  auswählen und über  einstellen
 - Kann zur Dosierung auf High oder Low gestellt werden.



○ **OFA_Zeit_____off**

- Über die Taste  auswählen und über  einstellen
- Hier kann die OFA-Zeit (Zeit der Überdosierung in Minuten) verändert werden.

○ **Kalibration_465mV**



- Über die Taste  auswählen und über  einstellen
- Die Abfolge der Kalibrierung haben wir 465 mV oder Funktion deaktiviert.

○ **Temperatur_Man_25°C**

- Über die Taste  auswählen und über  einstellen

- Speichern und das Programmmenü über die Taste ESC verlassen.

○ **Verlassen_____Sichern**

- Über die Taste  auswählen und über  einstellen

○ **Ansaugung_____**



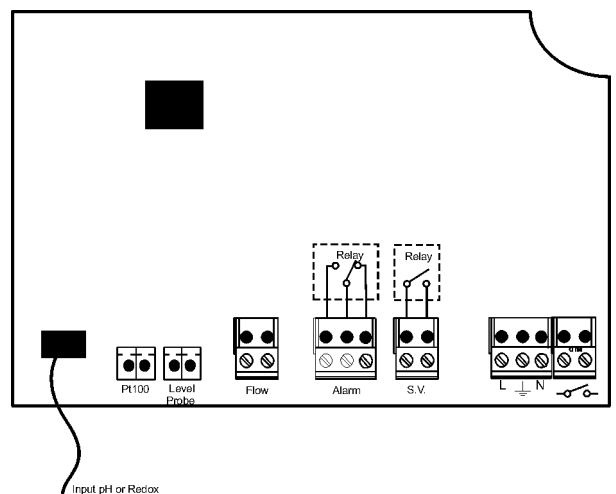

- Für die Funktion manuelles Ansaugen die Taste  3 Sekunden lang gedrückt halten

Anschluss der Kabel

- 1) Eingang Redoxfühler
- 2) Eingang Temperaturfühler (PT100)
- 3) Eingang Füllstandssonde (Produkt im Produkttank)
- 4) Durchflusseingang, Durchfluss Rückförpumppe (elektrisches Signal 230 Vac)
- 5) Ausgang Alarmrelais (Kontakt sauber, Relais 250 Vac, 10 A Widerstandsbelastung)
- 6) Ausgang Relais für Elektroventil (Kontakt sauber, Relais 250 Vac, 10 A Widerstandsbelastung)
- 7) Stromversorgung 230 Vac 50 Hz.
- 8) Stromunterbrechungsschalter.

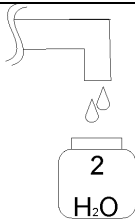
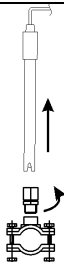
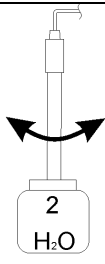
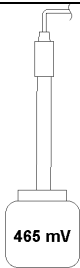

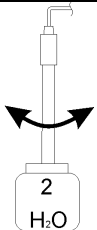
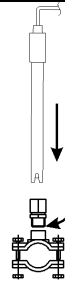
Kalibrierung der Redox-Sonde

<p>①</p> 	<p>②</p> 	<p>③</p>  <p>Die Sonde spülen</p>
<p>④</p>  <p>Die Sonde in die Pufferlösung halten</p>	<p style="text-align: center;">Kalibration</p> <p style="text-align: center;"></p> <p style="text-align: center;">Die Taste Kal 3 Sekunden lang drücken</p> <p>⑤</p>	<p style="text-align: center;">465mv_CAL_Drucken</p> <p style="text-align: center;"></p> <p style="text-align: center;">Die Kalibrierung dauert eine Minute</p> <p style="text-align: center;">60s_Pause</p> <p>⑥</p>
<p style="text-align: center;">465mv_Qualitat_100%</p> <p style="text-align: center;">Qualität der Sonde</p> <p>⑦</p>	<p>⑧</p>  <p>Die Sonde spülen</p>	<p>⑨</p> 
<p style="text-align: center;"></p> <p style="text-align: center;">Die Taste Kal 3 Sekunden lang drücken</p> <p>⑩</p>	<p style="text-align: center;">Normaler Mess- und Kontrollstatus</p> <p>⑪</p>	

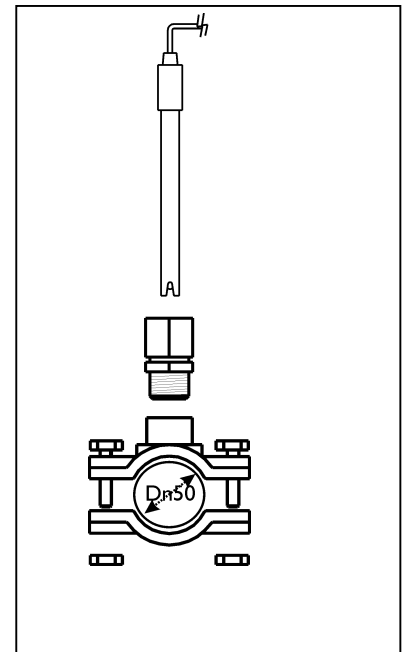
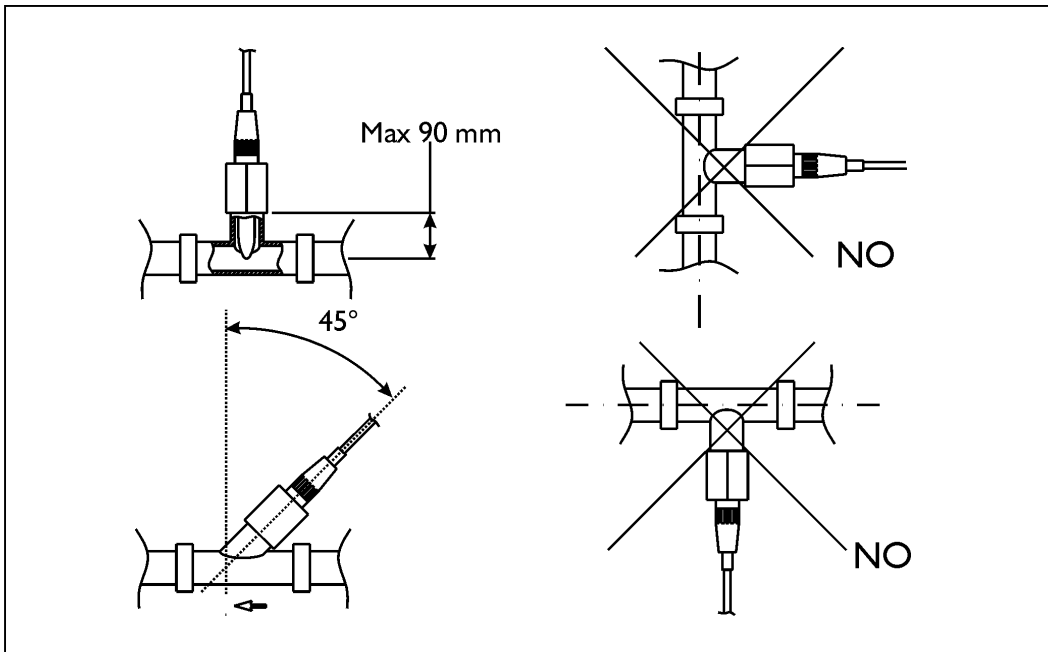

Alarm	Display	Relais	Was ist zu tun
Füllstandsalarm	Fullstand___465_m v	Alarm Relais geschlossen	- Die Taste Enter drücken, um den Alarm auszuschalten - Produkt im Produkttank auffüllen
Erster OFA-Alarm (Zeit >70%)	Alarm_OFA_465_m v	Alarm Relais geöffnet	- Die Taste Enter drücken, um den Alarm zu beseitigen
Zweiter OFA-Alarm (Zeit=100%)	STOP_OFA_465_mv	Alarm Relais geschlossen	- Die Taste Enter drücken, um den Alarm zu beseitigen
Wasserdurchfluss (Rückführungspumpe ausgeschaltet)	Fluss___465_mv	Alarm Relais geöffnet	- Wasserrückführungspumpe wieder einschalten.
Systemfehler	Parameter_Error	Alarm Relais geöffnet	- Enter drücken, um die Werkseinstellungen wieder herzustellen - System kaputt
Kalibrierfunktion	Fehler_465_mv	Alarm Relais geöffnet	- Die Sonde oder die Pufferlösung austauschen und die Kalibrierung wiederholen.

Werkparameter:

- Sprache = **UK (Englisch)**
- SetPoint Wert = **7,4 pH; 750mV (Rx)**
- Dosiermethode = **Säure; Niedrig (Rx)**
- OFA-Zeit = **OFF**
- Kalibrierung = **7/4 (2 Punkte); 465mV**
- Durchflusseingang = **OFF**

Um die Werkseinstellungen (Default) wieder herzustellen, wie folgt vorgehen:

- Das Basic-System ausschalten
- Die Taste UP (Aufwärts) und DOWN (Abwärts) gedrückt halten und das Basic-System einschalten.
- Das System zeigt folgendes an:**Initial Störung__no**
- UP (Aufwärts) drücken **Initial Störung__Yes**
- Die Taste Enter drücken, um die Parameter wieder herzustellen.

Contenido de la caja

- A) "Sistema de control
- B) Tornillos con tacos ($\phi = 6 \text{ mm}$)
- C) SRH-1 electrodo Redox
- D) 465mV soluciones tampones
- E) PSS3 porta sonda (1/2" GAS)
- F) Soporte de montaje para PSS3 2" pulgadas ($\phi=50 \text{ mm}$)

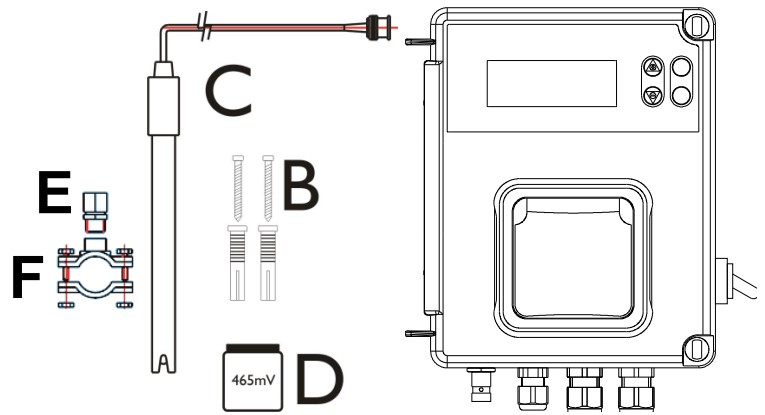

DIMENSIONES

Dimensiones (H – W – L)	234x162x108 mm
Peso	1 Kg.
Alimentación 50 Hz	230 VAC
Consumo	12 W
Rango medida	0 ÷ +1000 mV
Precision	$\pm 2 \text{ mV}$
Regulación electrodo	Automatic

MONTAJE PARED

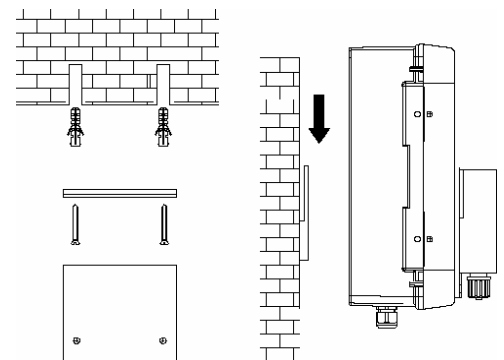

ATENCIÓN / ATTENZIONE / WARNING / ATTENTION / ACHTUNG

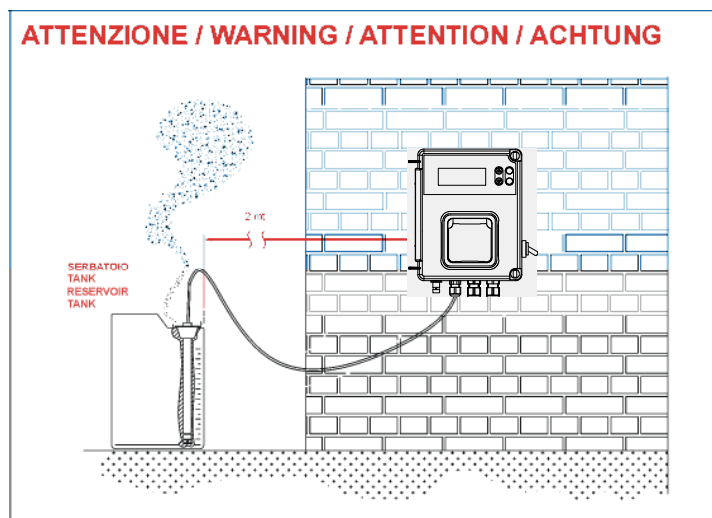



Instrucciones

Funciones:

- **Calibración**

- Presionar pulsador  durante 3 segundos
 - Rutina de calibración estándar para soluciones patrón pH 7 y pH4

- **Set Point ó Valor deseado**

- Presionar pulsador 
 - Mantener pulsado SET y con los pulsadores de subir y bajar  ajustar el valor deseado.



- **Sp_465mV**

- Configuración de parámetros. Presionar juntos  durante 5 segundos



- **Program_configuration**

- (Presionar  para las siguientes instrucciones)



- **Language_**

- Con Subir y Bajar  es posible elegir entre 5 idiomas EN, IT, SP, DE, FR
 - Pulsar  para salir



- **Flow_**

- Ajustar el valor con  y con los pulsadores de subir o bajar 
 - Es posible conectar (ON) o desconectar (OFF) la entrada de señal



- **setpoint_____465mV**

- Ajustar el valor con  y los pulsadores de subir o bajar 
 - Es posible ajustar desde 0 to 1000 mV



- **sp_type_____alto**

- Ajustar el valor con  y los pulsadores de subir o bajar 
 - Es posible Alto (dosificacion oxidante) o Bajo (dosificacion reductor).



○ **Time_ofa_____off**

- Ajustar el valor con  y los pulsadores de subir o bajar 
- Es posible ajustar el tiempo de OFA en minutos

○ **Calib_____465mV**



- Ajustar el valor con  y los pulsadores de subir o bajar 
- Es posible seleccionar 465 mV o función desconectada..

○ **Man_Temperature_25*C_**

- Ajustar el valor con  y los pulsadores de subir o bajar 

- Para salir y escapar del menú de programación pulsar la tecla ESC.

○ **Exit_____save**

- Ajustar el valor con  y los pulsadores de subir o bajar 

○ **priming_____**



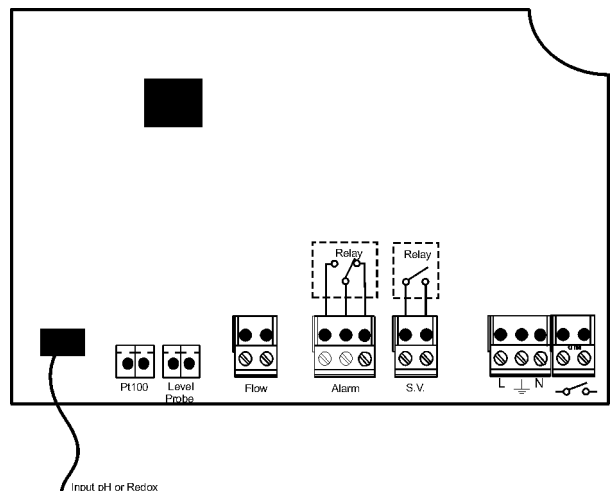

- Para cebar (cargar) la bomba dosificadora presionar el pulsador  durante 3 segundos.

Conexiones:

- 1) **Input Probe**, conexión electrodo.
- 2) **Input Temp**, sensor temperatura (PT100) no incluida,
- 3) **Input Level**, control de nivel del tanque de producto químico, no incluido
- 4) **Input Flow**, entrada de control de recirculación (entrada de 230 Vac)
- 5) **Alarm Relay** rele de alarma libre de potencial 250Vac 10 A.
- 6) **S.V. Relay** Rele para control de electro válvula libre de potencial 250Vac 10A
- 7) Alimentación 230 Vac
- 8) Interruptor de paro – marcha.

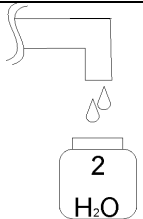
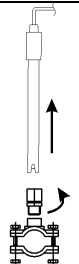
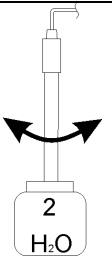
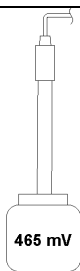

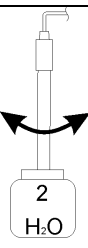
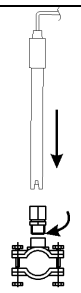
Calibración electrodo de Redox

 <p>1</p>	 <p>2</p>	 <p>3</p> <p>Lavar</p>
 <p>4</p> <p>Keep probe into Buffer solution</p>	<p>Calibración</p>  <p>Pulsar CAL durante 3 segundos</p> <p>5</p>	<p>465mv__Press_cal</p>  <p>Duración de la calibración 1 min.</p> <p>Esperar_____60s_____</p> <p>6</p>
<p>465mv_Calidad_100%</p> <p>Calidad electrodo</p> <p>7</p>	 <p>8</p>	 <p>9</p>
 <p>Presionar CAL durante 3 segundos</p> <p>10</p>	<p>Estado Normal.</p> <p>11</p>	

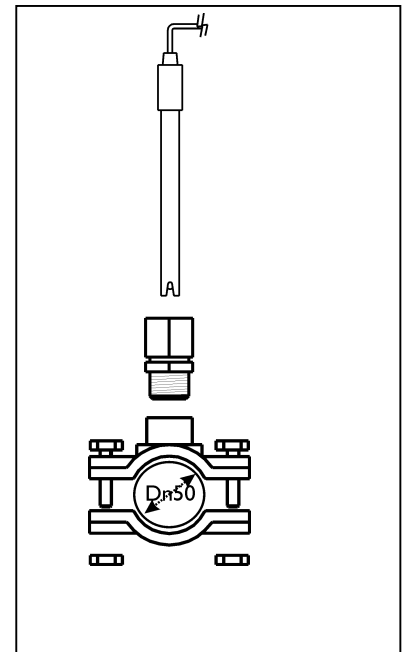
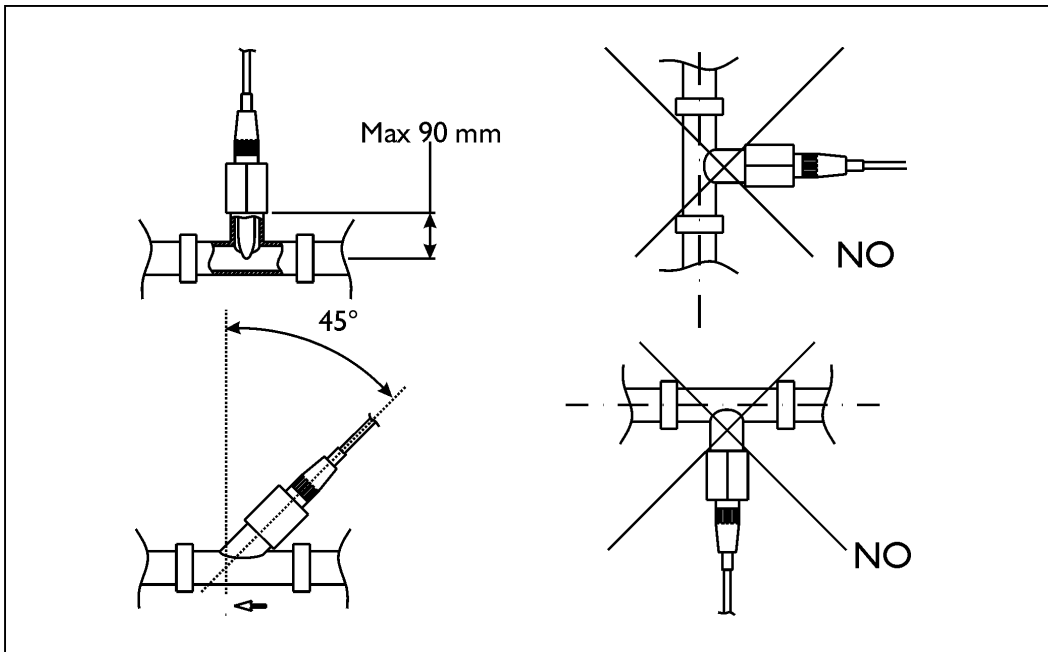

Alarma	Display	Rele	Acciones a hacer
Level	level ___ 465_mV	Rele de alarma cerrado	- Pulsar Enter para abrir el rele de alarma. - Rellenar el deposito de producto químico
OFA First Alarm (time >70%)	ofa_alarm ___ 465_mV	Rele de alarma abierto	- Pulsar Enter para aceptar.
OFA Second Alarm (time =100%)	ofa_stop ___ 465_mV	Rele de alarma cerrado	- Pulsar Enter para acepta
Flow Rate	Flow _____ 465_mV	Rele de alarma abierto	- Restaurar el caudal o recirculación.
System Error	Parameter_error	Rele de alarma abierto.	- Presione Enter para sustituir el valor defectuoso - Equipo averiado. - Posible obstrucción de la inyección
Calibration Funciont	Error_465_mV	Rele de alarma abierto.	- Sustituir el electrodo o solución patrón y repetir la calibración.

Parámetros de fabrica:

- Idioma = **UK**
- Set Point= **750mV**
- Tipo de dosificación = **Bajo**
- Tiempo OFA = **OFF**
- Calibración = **465mV**
- Entrada de caudal= **OFF**

Restaurar valores de fabrica:

- Desconectar la unidad electricamente
- Manteniendo pulsado subir y bajar dar corriente a la unidad.
- En el display parpadea **Init.default __no**
- Presionar el pulsador subir
- **Init.default __Yes**
- Presionar el pulsador Enter para restaurar los valores de fabrica..

Contenu de l'emballage

- A) Régulateur "Pool Basic Evo"
- B) Kit étrier de fixation
- C) Electrode Rx SRH-1
- D) Kit solution tampon 465mV
- E) Porte sonde PSS3 (1/2" GAS)
- F) Collier de prise en charge pour porte sonde et clapet d'injection ($\phi=50$ mm)

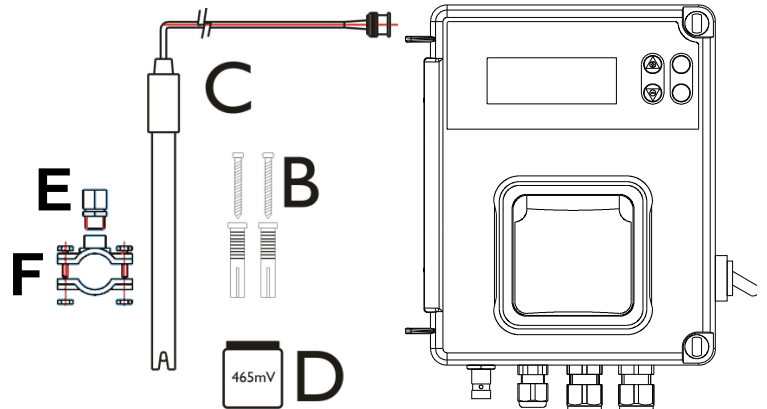

SPÉCIFICATIONS TECHNIQUES

Dimensions (H – L – P)	234x162x108 mm
Poids	1 kg
Alimentation	230 VC.A.
Consommation	12 W
Échelle de mesure	0 ÷ +1000 mV
Précision de la mesure	± 10 mV
Mesure d'exactitude	± 2 mV
Étalonnage de l'électrode	Automatique

Fixation murale

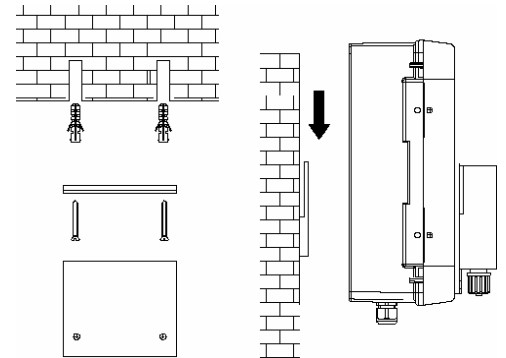

ATTENZIONE / WARNING / ATTENTION / ACHTUNG

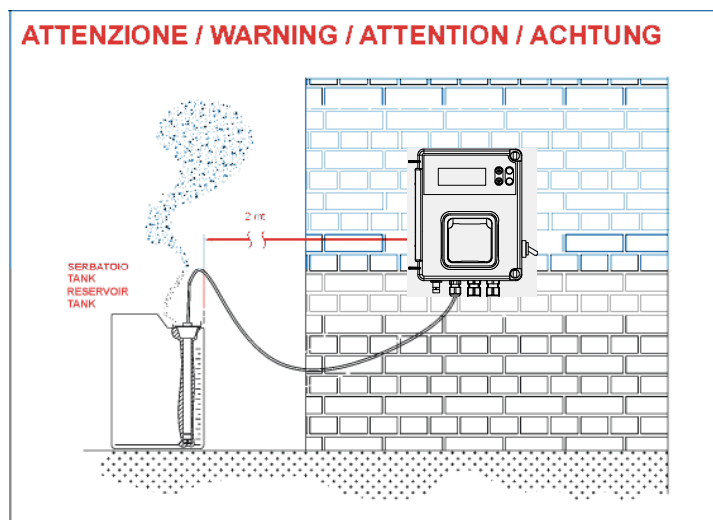

Réglages

Fonction :

- **Étalonnage**

- Appuyer sur la touche  pendant 3 secondes
 - Séquence Standard étalonnage pour la solution tampon 465mV.

- **Set Point ou point de consigne**

- appuyer sur la touche 
 - Maintenir la touche Set Key appuyée et modifier la valeur par les flèches

- **Sp 465mV**

- Appuyer sur les touches  (en même temps) pendant 5 secondes pour activer le menu configuration:

- **Parametres**

- Appuyer sur  pour programmer les paramètres ci-après



- **Langue**

- (On peut régler 5 différentes langues EN, IT, SP, DE, FR)



- **Niveau**

- (Appuyer sur les flèches Haut et Bas)
- On peut activer (ON) ou désactiver (OFF) l'entrée Flux (haute tension) connectée en parallèle à la pompe de circulation



- **Consigne _____ 465mV**

- Sélectionner avec la touche  et programmer avec flèche 
- On peut modifier la valeur de de 0 à +1000 mV.



- **Produit_Dose__ Low**

- Sélectionner avec la touche  et programmer avec flèche 
- On peut le modifier pour dosages High (haut) ou Low (bas).



- **Temps_OFA_____ off**

- Sélectionner avec la touche  et programmer avec flèche 
- On peut modifier le temps OFA (minutes), temps de surdosage

○ Calibrace__465mV

- (Sélectionner avec la touche  et programmer avec flèche )
- On peut modifier la séquence de calibrage, le choix est entre 465 mV et fonction désactivée.

○ Correction_Temp_25°C

- Sélectionner avec la touche  et programmer avec flèche 
- Enregistrer puis quitter le menu Programme avec la touche ESC.

○ Exit_Sauvegarder

- Sélectionner avec la touche  et programmer avec flèche 

○ Amorcage



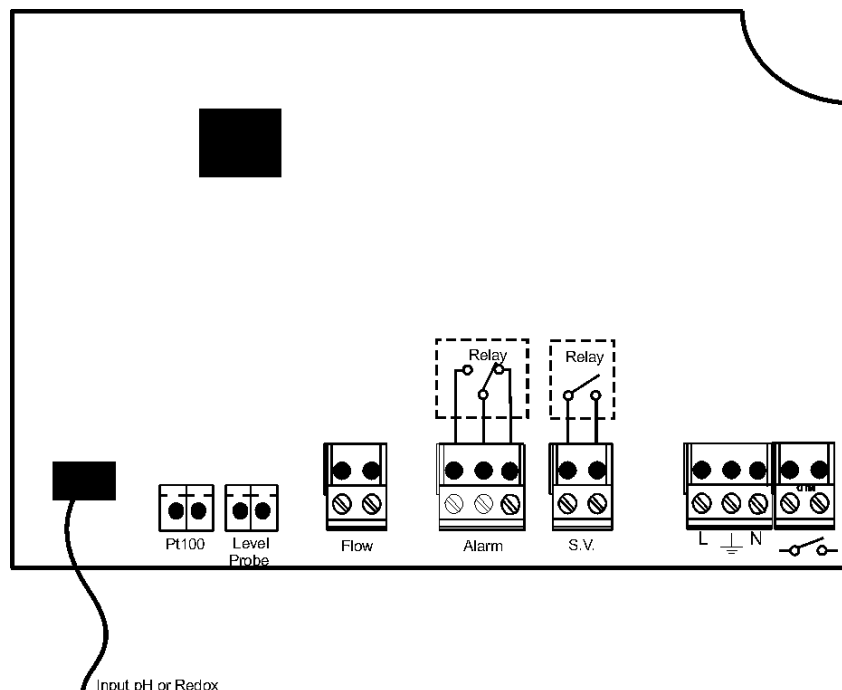

Pour la Fonction amorçage en manuel, maintenir la touche flèche  appuyée pendant 3 secondes

Connexion des câbles :

- 1) Entrée sonde Redox
- 2) Entrée Sonde Température (PT100)
- 3) Entrée sonde de niveau (Produit dans le Bidon)
- 4) Entrée Flow, débit pompe de recirculation (signal électrique 230 Vc.a.)
- 5) Sortie Relais Alarme à distance (Contact libre, Relais 250 Vc.a. 10 A résistif)
- 6) Sortie Relais Alarme pour électrovanne (Contact libre, Relais 250 Vc.a. 10 A résistif)
- 7) Alimentation 230 Vc.a. 50 Hz.
- 8) Interrupteur d'alimentation

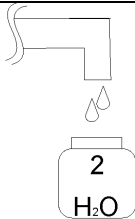
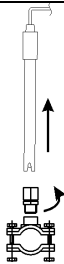
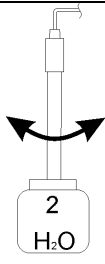
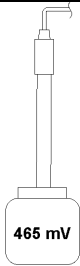

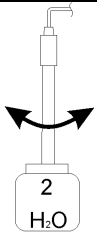
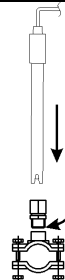
Calibrage sonde Redox

<p>①</p> 	<p>②</p> 	<p>③</p>  <p>Laver la sonde</p>
<p>④</p>  <p>Maintenir la sonde dans la solution tampon</p>	<p style="text-align: center;">Calibrage</p>  <p>Appuyer sur la touche Cal pendant 3 secondes</p> <p>⑤</p>	<p>465mv_ Presser_CAL</p>  <p>Le calibrage dure une minute.</p> <p>Patienter ___60s</p> <p>⑥</p>
<p>465mv_ Qualite' _100%</p> <p>Qualité de la sonde</p> <p>⑦</p>	<p>⑧</p>  <p>Laver la sonde</p>	<p>⑨</p> 
<p>⑩</p>  <p>Appuyer sur la touche Cal pendant 3 secondes</p>	<p>⑪</p> <p>État normal de mesure et de contrôle</p>	

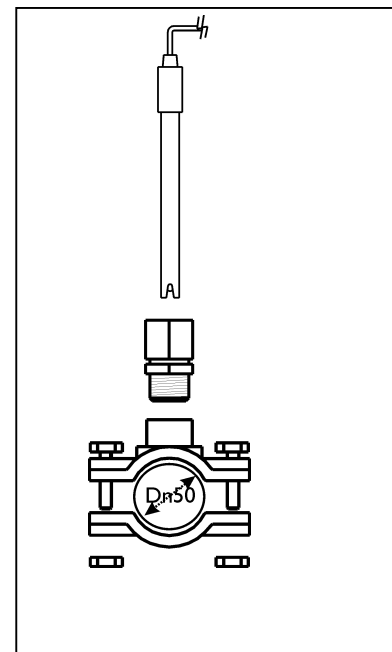
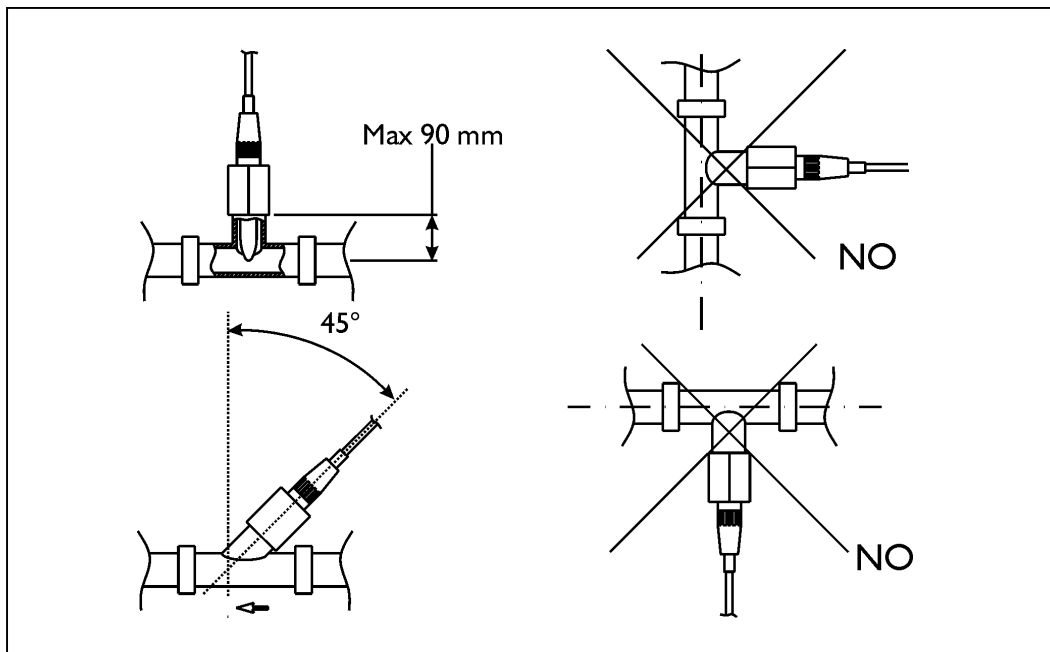

Alarme	Écran	Relais	Actions à exécuter
Niveau	Niveau__465_mV	Alarme relais fermé	- Appuyer sur la touche Enter pour désactiver l'alarme à distance - Rétablir le niveau de produit dans le bidon
OFA Première Alarme (Temps >70%)	Alarme_OFA_465_mV	Alarme relais ouvert	- Appuyer sur la touche Enter pour désactiver l'alarme
OFA Deuxième Alarme (Temps=100%)	STOP_OFA__465_mV	Alarme relais fermé	- Appuyer sur la touche Enter pour désactiver l'alarme
Débit eau (pompe de recirculation éteinte)	Debit_____465_mV	Alarme relais ouvert	- Réactiver la pompe de circulation eau.
Erreur de système	Parameter_Error	Alarme relais ouvert	- Appuyer sur Enter pour restaurer les paramètres par défaut - Système endommagé
Fonction d'étalonnage	Erreur_465_mV	Alarme relais ouvert	- Remplacer la Sonde ou la Solution tampon et répéter le calibrage.

Paramètres d'usine :

- Langue = **UK (Inglese)**
- Set Point valeur = **750mV**
- Méthode de dosage = **Basse**
- Temps OFA (alarme de surcharge) = **OFF**
- Calibrage = **465mV**
- Entrée Flux = **OFF**

Pour restaurer les paramètres par défaut (Défaut), agir de la façon suivante:

- Arrêter le système Basic
- Activer le système Basic en maintenant les touches flèche HAUT (UP) et flèche BAS (DOWN) appuyées.
- Le Système affiche **Init.default__no**
- Appuyer sur flèche HAUT (UP)
Init.default__Yes
- Appuyer sur la touche Enter pour restaurer les paramètres.

Contenuto nella Scatola

- A) Sistema di controllo (modello standard)
- B) Tasselli a vite ($\phi=6$ mm)
- C) SRH-1 elettrodo pH
- D) 465mV soluzioni tampone
- E) PSS3 porta sonda (1/2" Gas)
- F) Staffa di montaggio per PSS3 2" pollici ($\phi=50$ mm)

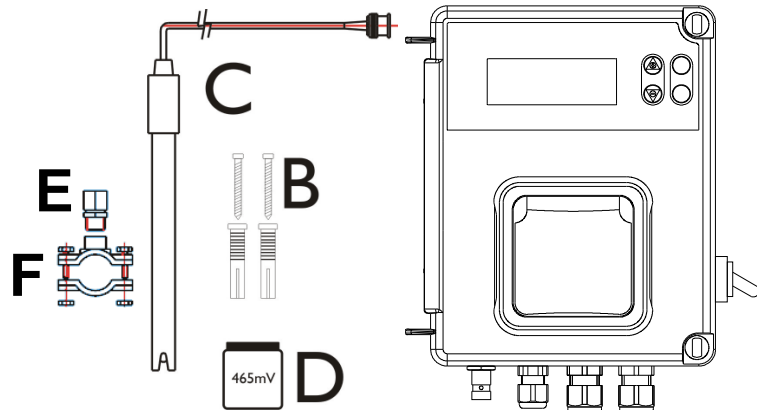

TECHNICAL SPECIFICATIONS

Dimensioni (A – L – P)	234x162x108 mm
Peso	1 kg
Alimentazione	230 VAC
Consumo	12 W
Uscita sistema	230 VAC
Scala Misura	0 ÷ +1000 mV
Precisione Misura	± 10 mV
Accuratezza Misura	± 2 mV
Calibrazione Elettrodo	Automatica

Montaggio Parete

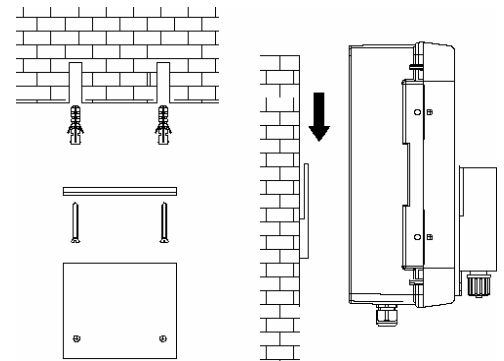

ATTENZIONE / WARNING / ATTENTION / ACHTUNG

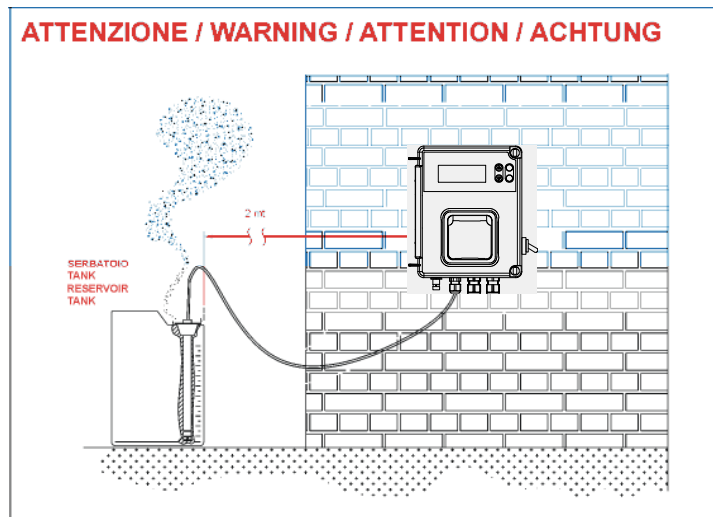

Impostazioni

Funzione:

- **Calibrazione**

- (Premere tasto  per 3 Secondi):

- Sequenza Standard calibrazione per soluzione tampone 465mV.

- **Set Point**

- Premere tasto: 

- Tenere premuto Set Key e modificare valore con tasto 

- **Sp_465mV**

- Premere tasti  (insieme) per 5 Secondi e si eseguirà il menu configurazione:

- **MENU CONFIGURAZIONE**

- (Premere  impostare le seguenti voci)

- **LINGUA**

- (Con il pulsante  si può imporre 5 lingue EN, IT, SP, DE, FR)



- **FLUSSO**



- Selezionare con il tasto 
- Si può abilitare(ON) or disabilitare (OFF) l'ingresso Flusso (alta tensione) collegato in parallelo alla pompa di ricircolo



- **Setpoint_680 mV**



- Selezionare con il tasto  e impostare con 
- Si può modificare il valore da da 0 a +1000 mV.



- **Tipo_Setpoint_High**

- Selezionare con il tasto  e impostare con 
- Si può modificare per attivazioni High or Low.

- **Tempo_OFA__off**
 - Selezionare con il tasto  e impostare con 
 - Si può modificare il tempo (minuti) di OFA tempo di savra dosaggio

- **Calibrazione__465mV**
 - Selezionare con il tasto  e impostare con 
 - Si può modificare la sequenza di calibrazione per il Redox abbiamo 465 mV o funzione disabilitata.

- **Temperatura_Man_25°C**
 - Selezionare con il tasto  e impostare con 
 - Salvare ed uscire dal menù Programma con il tasto ESC.

- **Uscita__Salva**
 - Selezionare con il tasto  e impostare con 



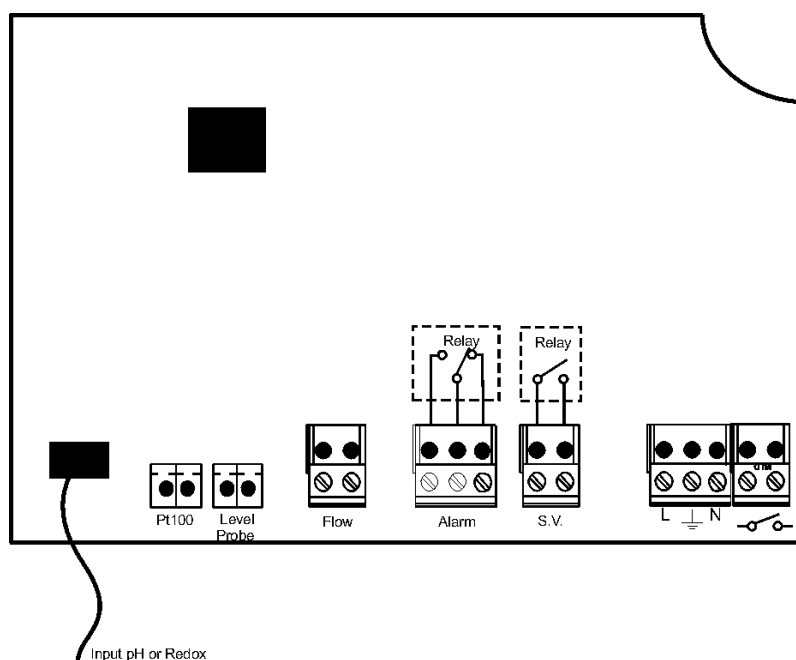

- **Adescamento**
 - Funzione adescamento manuale tenere premuto il tasto  (UP) per 3 secondi

Connessione Cavi:

- 1) Ingresso sonda Redox
- 2) Ingresso sonda Temperature (PT100)
- 3) Ingresso sonda Livello (Prodotto nel Bidone)
- 4) Ingresso Flow, flusso pompa di ricircolo (segnale elettrico 230 Vac)
- 5) Uscita Relè Allarme remoto (Contatto pulito, Relè 250 Vac 10 A Resistivo)
- 6) Uscita Relè per Elettrovalvola (Contatto pulito, Relè 250 Vac 10 A Resistivo)
- 7) Alimentazione 230 Vac 50Hz.
- 8) Interruttore di alimentazione.

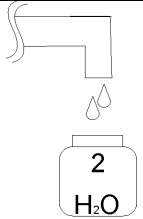
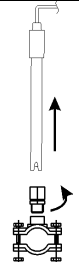
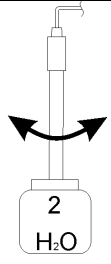
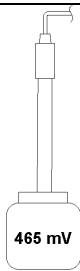

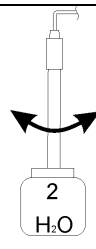
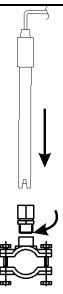
Calibrazione sonda Redox

<p>①</p> 	<p>②</p> 	<p>③</p>  <p>Lavare la sonda</p>
<p>④</p>  <p>Mantenere la sonda nella soluzione tampone</p>	<p>Calibrazione</p>  <p>Premere il tasto Cal 3 Secondi</p> <p>⑤</p>	<p>465mv__Premere_CAL</p>  <p>La calibrazione dura un minuto</p> <p>Attendere__60s</p> <p>⑥</p>
<p>465mv_Qualita'_100%</p> <p>Qualità Sonda</p> <p>⑦</p>	<p>⑧</p>  <p>Lavare la sonda</p>	<p>⑨</p> 
 <p>Premere il tasto Cal 3 Secondi</p> <p>⑩</p>	<p>Normale Stato di misura e controllo</p> <p>⑪</p>	

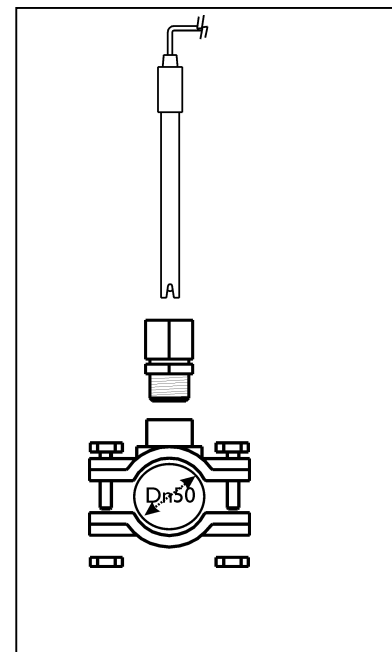
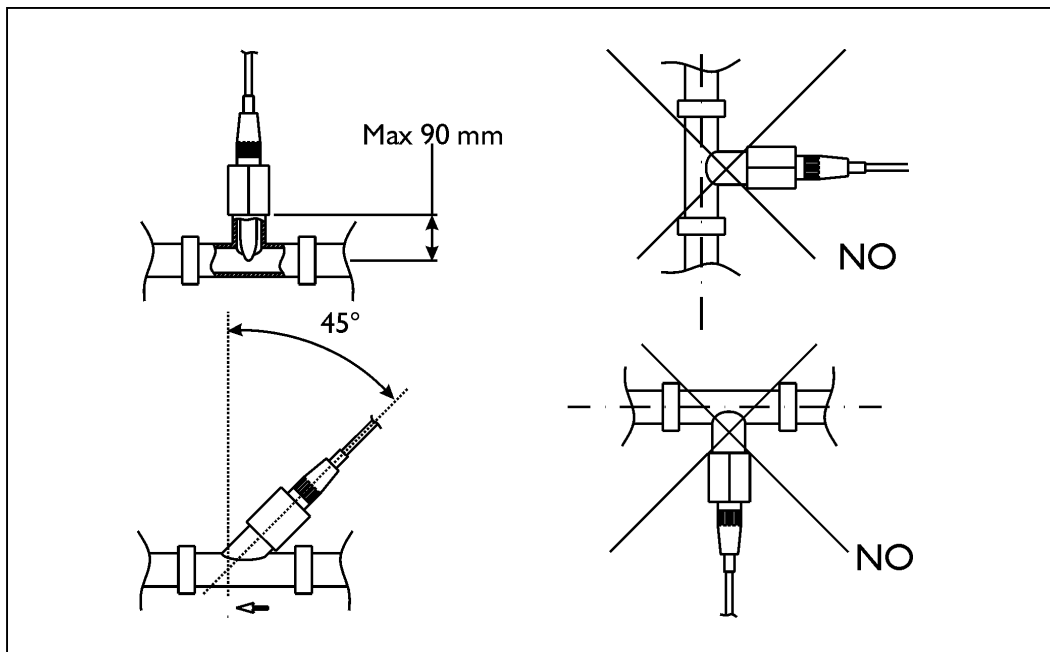

Allarme	Display	Relè	Azioni da fare
Livello	Livello _____ 465mV	Allarme Relè Chiuso	- Premere il tasto Enter per spegnere l'allarme remoto - Ripristinare prodotto nel bidone
OFA Primo Allarme (Tempo >70%)	Allarme_OFA_ 465mV	Allarme Relè Aperto	- Premere il tasto Enter per eliminare l'allarme
OFA Secondo Allarme (Tempo=100%)	STOP_OFA_ 465mV	Allarme Relè Chiuso	- Premere il tasto Enter per eliminare l'allarme
Flusso acqua (Pompa di ricircolo spenta)	Flusso _____ 465mV	Allarme Relè Aperto	- Ripristinare pompa di ricircolo acqua.
Errore di Sistema	Parameter_Error	Allarme Relè Aperto	- Premere Enter per ripristinare i parametri di fabbrica - Sistema Rotto
Funzione di Calibrazione	Errore_ 465_mV	Allarme Relè Aperto	- Sostituire Sonda o Soluzione tampone e ripetere la calibrazione.

Parametri di Fabbrica:

- Lingua = **UK (Inglese)**
- Set Point valore = **750mV**
- Metodo di Dosaggio = **Basso**
- Tempo OFA = **OFF**
- Calibrazione = **465mV**
- Ingresso Flusso = **OFF**

Per ripristinare I parametri di fabbrica (Default) eseguire i seguenti passi:

- Spegnere il sistema Basic
- Mantenere premuto il tasto UP (su) e DOWN (giù) accendere il sistema Basic .
- Il Sistema visualizzerà **Init.default__no**
- Premere UP (su) **Init.default__Yes**
- Premere il tasto Enter per ripristinare i parametri.