

User Manual

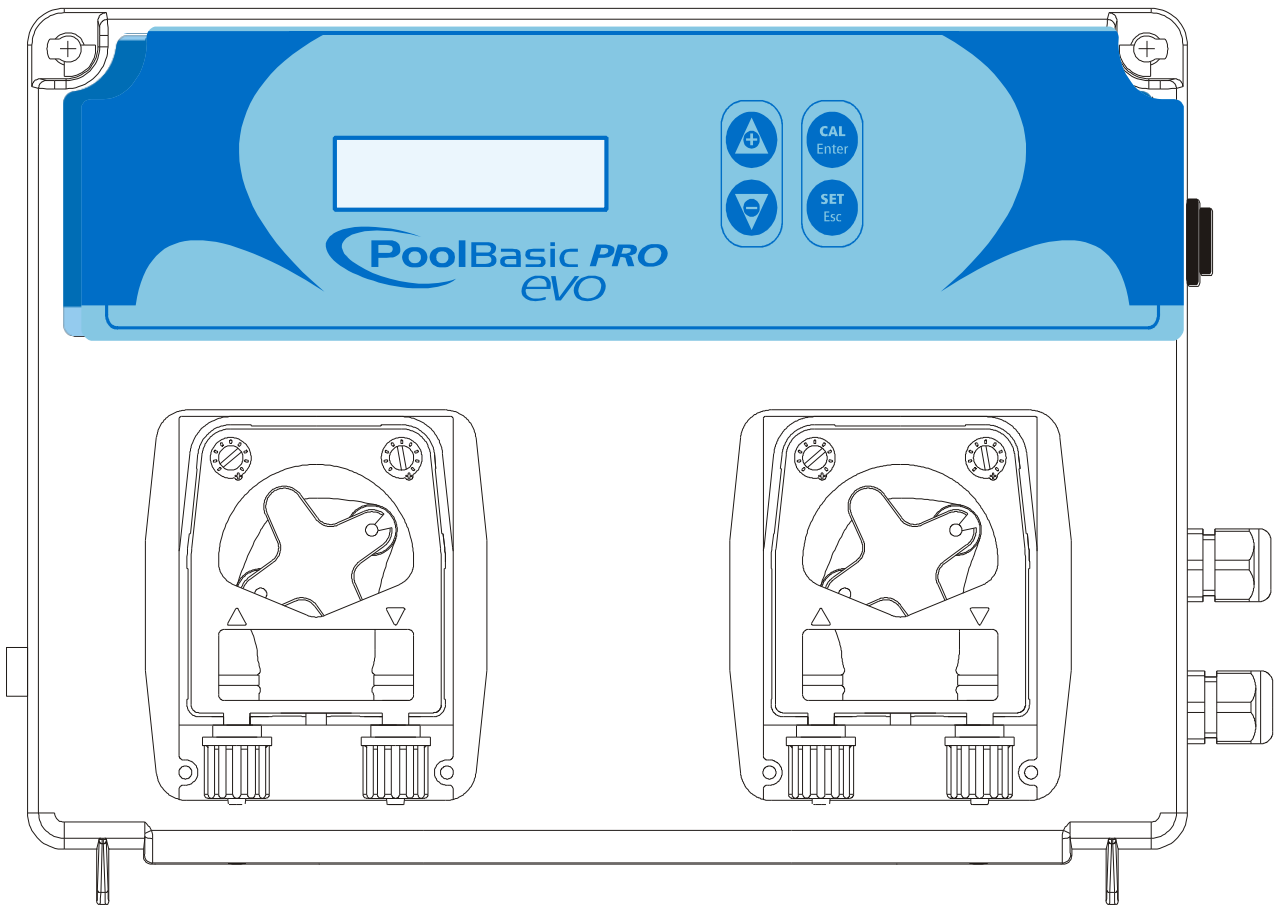

CONTENTS

1. GENERAL INTRODUCTION	3
2. INSTALLATION PRECAUTIONS	3
3. IDENTIFICATION OF COMPONENTS	4
4. TECHNICAL SPECIFICATIONS.....	5
5. ASSEMBLY INSTRUCTIONS.....	6
5.1 APPLICATION EXAMPLE	7
6. DESCRIPTION OF THE CIRCUIT	8
7. CALIBRATION MENU	8
7.1 CALIBRATION.....	8
8. PROGRAMMING.....	10
9. DOSING METHOD.....	13
9.1 PH PROPORTIONAL DOSING	13
9.2 ON/OFF PH DOSING	13
9.3 ALARM FOR THE PH SET POINT	14
10. ACTIVATIONS	15
11. ALARMS	15
12. PRE-DEFINED CONTROL PARAMETERS	15
13. LIST OF POSSIBLE ANOMALIES AND RELATIVE SOLUTIONS	16
14. HANDLING	17
15. STORING THE PUMP AFTER USE	18
WARNINGS.....	18

1. GENERAL INTRODUCTION

The **Pool Basic Pro EVO** control method belongs to a new line of instruments carefully developed by the supplier for the innovative management of pools. This device is easy to use and permits continuous control of the pH.

The peristaltic pumps have a 1,5 l/h flow rate for pH regulation and have a pressurised injection flow rate up to 1.5 bar.

This easy-to-use instrument does not require special maintenance operations. It is equipped with a self-regulation procedure and automatic control of the electrode's state.

2. INSTALLATION PRECAUTIONS

WARNING!!!

Disconnect power before carrying out ANY operation inside the control panel of the Pool Basic Pro EVO device.

NON-OBSERVANCE OF THE INSTRUCTIONS CONTAINED IN THE PRESENT MANUAL COULD CAUSE INJURY TO PEOPLE AND/OR DAMAGE TO THE DEVICE.

WARNING

During installation of the **Pool Basic Pro EVO** device, proceed as follows:

- Make sure that the supply voltage coincides with the one indicated on the label on the side of the device.
- Make sure that the injection pressure is below 1.5 bar.
- Make sure that the pump's protective cover is properly latched.
- Make sure that the suction hose is immersed with the relative foot (PVC hose) in the tank of the product which must be injected and that it is connected to the pump (symbol on cover ▲). After carrying out the checks stated above, tighten the connector nut.
- Connect one end of the delivery hose (▼ symbol on cover) to the pump and connect the other end to the pool through the injection valve.

NOTE: To insert the product which must be injected into the pump when starting for the first time and every time the tank is changed, set the switch to forced running using the button.

3. IDENTIFICATION OF COMPONENTS

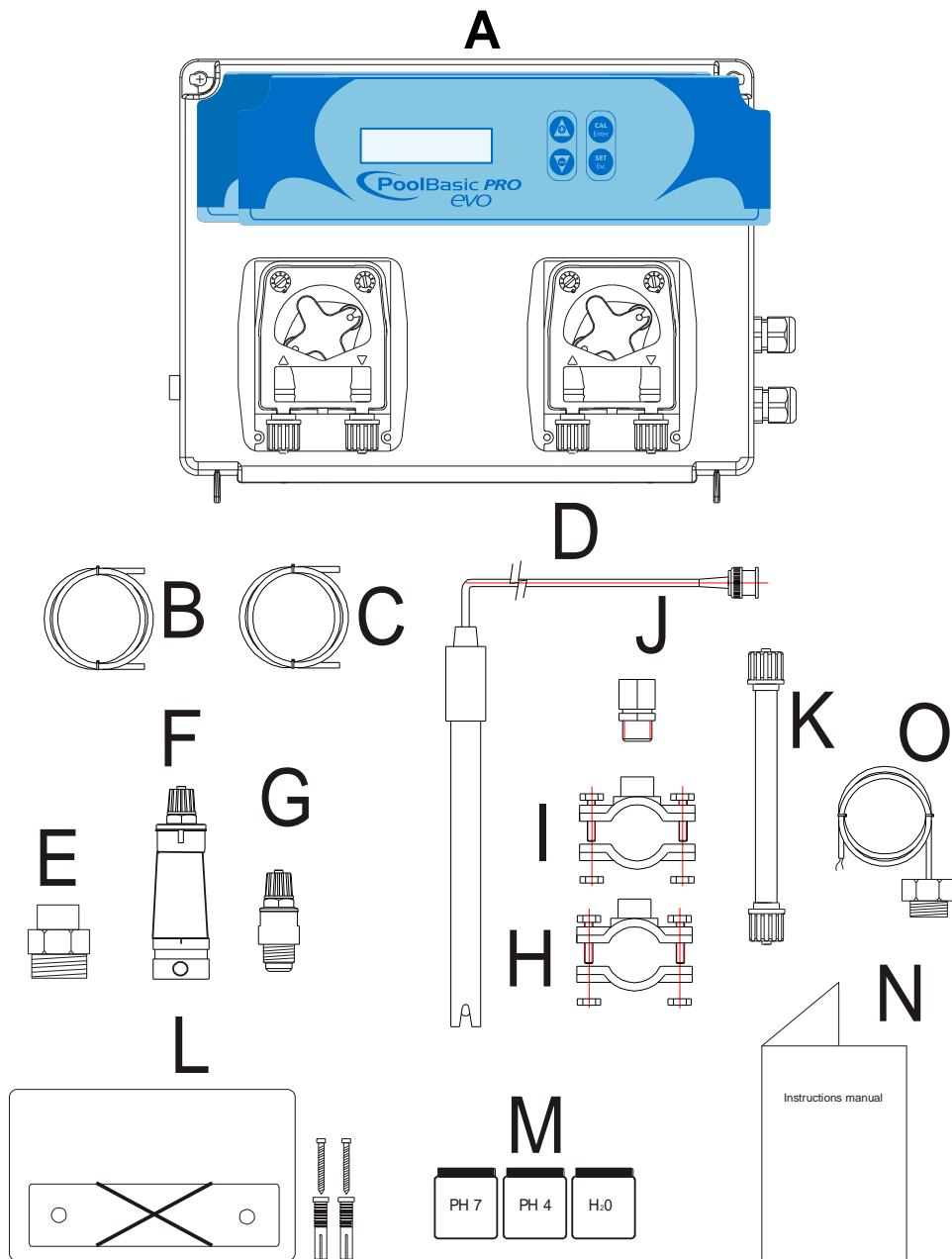

KEY

- A. **Pool Basic Pro EVO** regulator
- B. Suction hose in PVC Crystal 4x6 (4 m) x 2
- C. Delivery hose in PE 4X6 (5 m) x 2
- D. pH Electrode model SPH-1
- E. Reducer for injection valve x 2
- F. Duckbill valve in FPM (3/8" GAS) x 2
- G. Suction foot (PVC hose) x 2
- H. Tapping double-bolt clamp for fastening PSS3 probe holder onto 2" $\phi=50$ mm hose
- I. Tapping double-bolt clamp for fastening injection valve onto 2" $\phi=50$ mm hose x 2
- J. Probe holder model PSS3 (1/2" GAS)
- K. Hose 3x7
- L. Fixing bracket kit
- M. pH 4, pH 7, H₂O Buffer solution kit
- N. Instruction Manual

O. Temperature sensor

4. TECHNICAL SPECIFICATIONS

- **Power supply:** 100÷240 Vac 50/60 Hz 30 watt
- **Switch:** on side of box
- **Inlet measurements:** pH, through BNC
 - pH scale: 0÷14.0 pH
 - pH precision: +/-0.1 pH
- **Temperature Scale:** 0÷100 °C (PT100 sensor)
- **Pump flow rate** with transaxle technology:
 - **pH:** 1.5 l/h (hose 6X10) 1.5 bar
 - **H₂O₂:** 0.4 l/h (hose 3X7), 1.5 l/h (hose 6X10) 1.5 bar
- **Pump relay pH:** 10 A 250 V (dry contact)
- **Relay for alarm:** 10 A 250 V (dry contact)
- **Relay for H₂O₂:** 10 A 250 V (dry contact)
- **Dedicated power for pumps:** 240 Vac 10 watt
- **Input signal:** 100÷240 Vac
- **Level probe:** pH, H₂O₂

Install the **Pool Basic Pro EVO** control device on a hard support (vertical wall) where it can be easily accessed by the operator. Attach the **Pool Basic Pro EVO** control device using the provided fixing bracket (distance between centre of holes: 95mm. Hole Ø 6). Before carrying out any operation inside the equipment, make sure that the switches are on 0. Unscrew the two screws on the upper part of the equipment by a quarter of a turn and the front side will fold down on the hinges.

5. ASSEMBLY INSTRUCTIONS

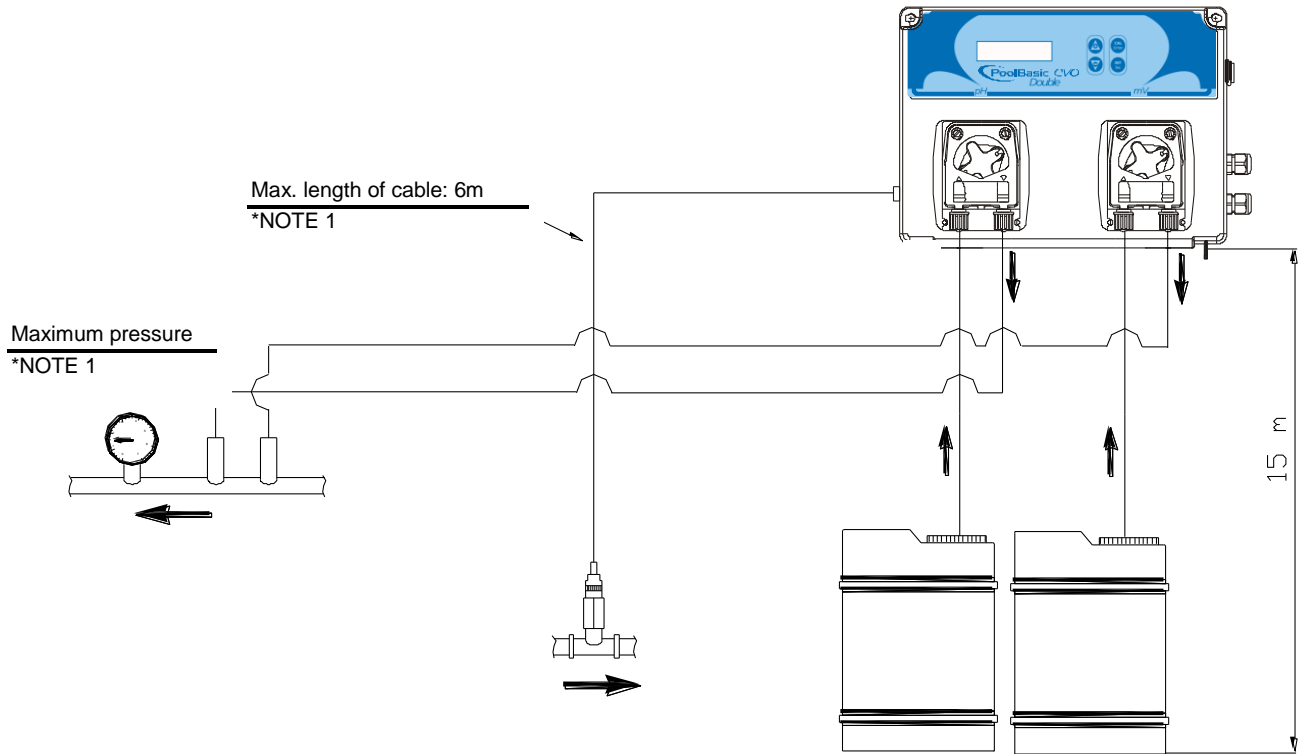

***NOTE 1: FOR LARGE PUMPS, THE CABLE MUST PASS THROUGH AN AREA OTHER THAN THE POWER SUPPLY ZONE IN ORDER TO PREVENT CURRENT DISTURBANCES.**

***NOTE 2: THE MAX. PRESSURE MUST NOT EXCEED 1.5 BAR.
TO INCREASE THE HOSE'S LIFETIME, THE PRESSURE MUST NOT EXCEED 1 BAR.**

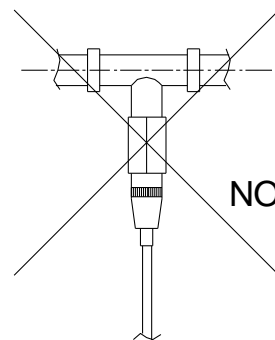
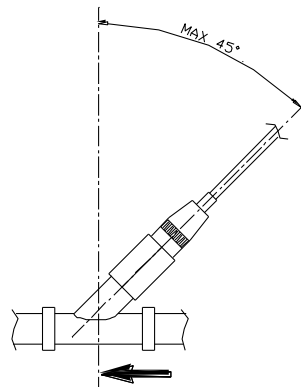
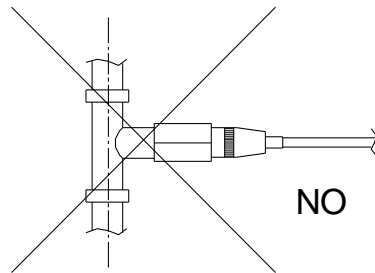
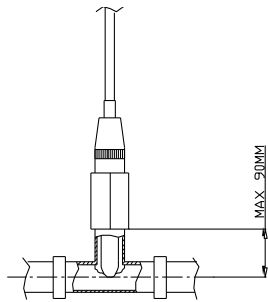

5.1 APPLICATION EXAMPLE

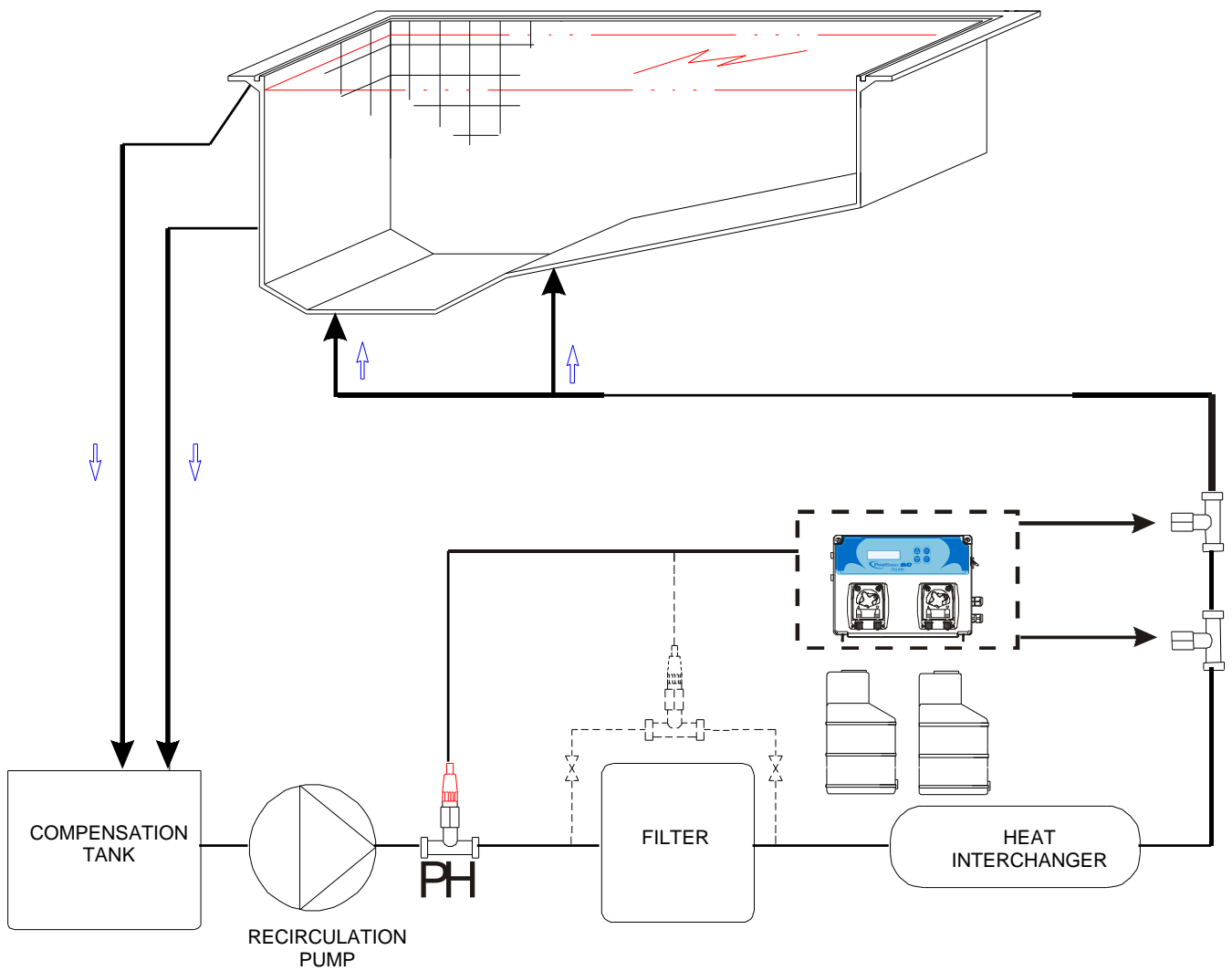

Note:

The linear distance of the hose between the probe and the point of injection must not be less than 60cm.

6. DESCRIPTION OF THE CIRCUIT

- 1) Inlet pH measurement
- 2) Inlet temperature probe
- 3) Inlet probe level for product pH
- 4) Inlet probe level for product H₂O₂
- 5) Keyboard input
- 6) Flow (recirculation pump)
- 7) Relay for pH product, external pump.
- 8) Alarm relay
- 9) Relay for H₂O₂ product, external pump.
- 10) Power supply input
- 11) Switch
- 12) Fuse
- 13) Power supply for pH pump
- 14) Power supply for H₂O₂ pump

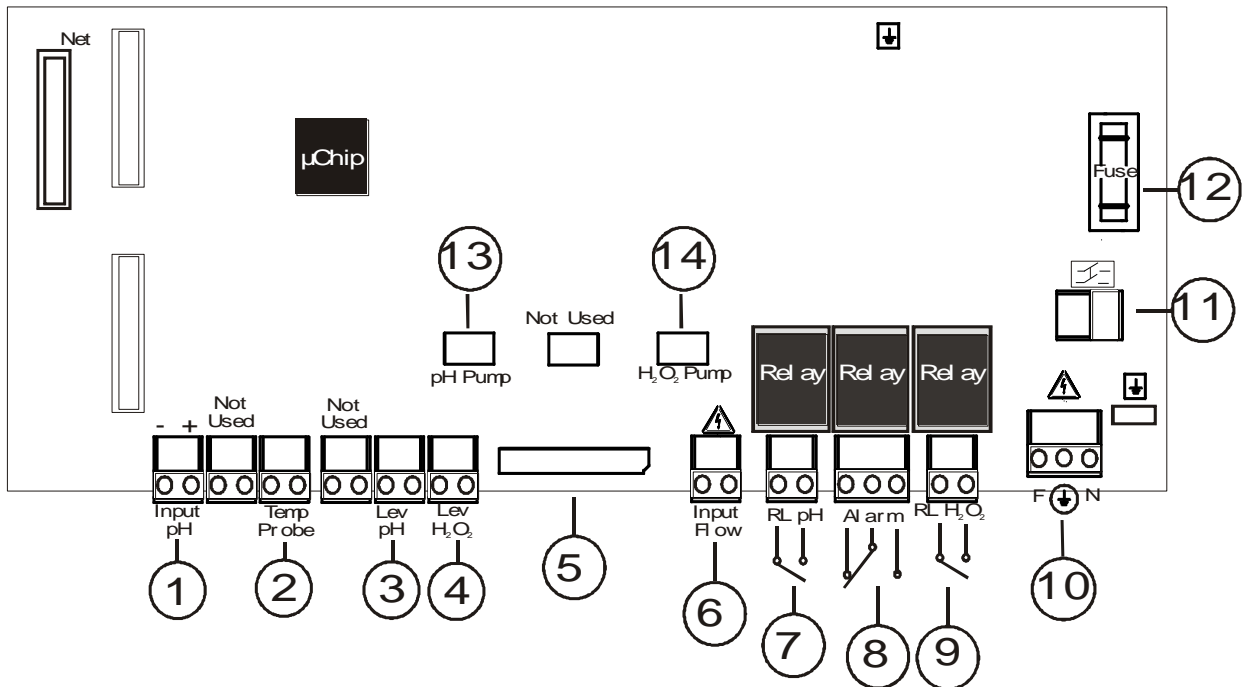

7. CALIBRATION MENU







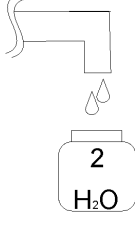
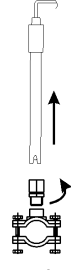
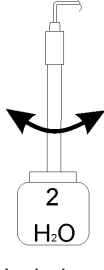
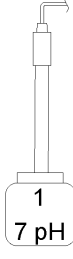

7.1 Calibration

Before proceeding, the calibration must be enabled. Scroll down the menu **Advanced**→**Cal**, the display will show:

Calibration Menu Display	Settings
	Press ENTER to access the menu.
	Press ENTER and the + and – keys to modify the calibration. Select Full and confirm with ENTER .

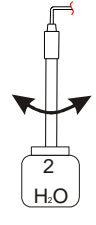
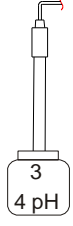
Exit the menu and return to the normal system status.

7.1.1 Calibrating the pH probe

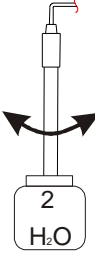
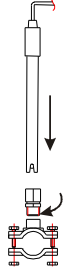
<p>1</p>  <p>Get some water</p>	<p>2</p>  <p>Remove the probe from the probe holder</p>	<p>3</p>  <p>Wash the probe</p>
<p>4</p>  <p>Keep the probe in the buffer solution pH 7</p>	 <p>5</p> <p>Press and hold down the Cal button for 3 seconds</p>	 <p>6</p> <p>Press Cal to start calibration with a buffer solution pH 7</p>
 <p>7</p> <p>The calibration takes 1 minute</p>	 <p>8</p> <p>Probe quality</p>	<p>9</p>  <p>Wash the probe</p>
<p>10</p>  <p>Keep the probe in the buffer solution pH 4</p>	 <p>11</p> <p>Press Cal to start calibration with a buffer solution pH 4</p>	 <p>12</p> <p>The calibration takes 1 minute</p>
 <p>13</p> <p>Probe quality</p>	<p>14</p>  <p>Wash the probe</p>	<p>15</p>  <p>Put the probe back in the probe holder and press Cal to finish</p>







8. PROGRAMMING

The programming menu can be accessed by simultaneously pressing the **Cal** and **Set** keys for at least 3 seconds.

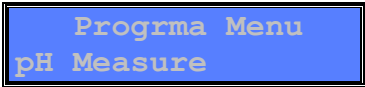



Upon release of the keys the display will show:

<i>Language Display</i>	<i>Settings</i>
	Press Enter and the + and – keys to change the language: FR, EN, IT, ES, DE

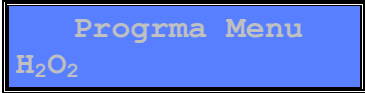
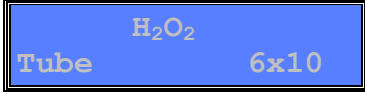
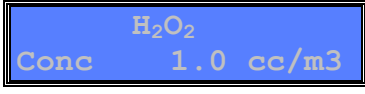
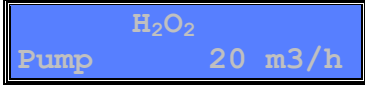
To prime the **pH** pump, press the **UP** button for at least 3 seconds and release it to stop the operation. To prime the **H₂O₂** pump repeat the same procedure pressing the **DOWN** button for at least 3 seconds.

<i>pH measurement display</i>	<i>Settings</i>
	Use Enter to access the sub-menus: <ul style="list-style-type: none"> • Setpoint • Dos type • OFA time • Alr Band • Type
	Press Enter and the + and - keys to change the Set Point value (0÷14 pH)
	Press Enter and the + and - keys to change the Set Point type. <ul style="list-style-type: none"> • Acid • Alkaline
	Press Enter and the + and - keys to set the OFA time to OFF or from 1 to 240 min. (see Paragraph 9.5)
	Press Enter and the + and - keys to set the band alarm from 1 to 3 pH.
	Press Enter and the + and - keys to change the dosing type. <ul style="list-style-type: none"> • PROP (see Paragraph 9.1). • ON/OFF (see Paragraph 9.2). • OFF (dosing disabled)



<i>H₂O₂ measurement display</i>	<i>Settings</i>
	Use Enter to access the sub-menus: <ul style="list-style-type: none"> • Hose • Conc. • Pump
	Use Enter to modify the dimensions of the hose (3x7 or 6x10mm) and the system automatically calculates the flow rate with the other hose without changing any parameters (the factory-set hose is 6x10).
	Enter the concentration value of the product to be dosed with the 3x7 hose. This value ranges from 1 to 4cc/m3. With the 6x10 hose the range is 1 to 15cc/m3.
	Enter the value of the system recirculation pump. It ranges from 2 to 100m ³ /h

<i>Advanced Display</i>	<i>Settings</i>
	Use Enter to access the sub-menus: <ul style="list-style-type: none"> • Temp. • Flow • Cal. • Password
	Press Enter and the + and - keys to set the compensation temperature from 1 to 100°C. If a temperature probe is connected, the menu item will not be displayed as the system will compensate automatically with the value read by the probe itself.
	Press Enter and the + and - keys to set the flow to OFF or ON. This item enables or disables the Flow inlet (see. Paragraph 10.0).
	Press Enter and the + and - keys to set the calibration to OFF or enable it to ON (Full)
	Press Enter to set the system access and modification password. Use the + key to modify the figure and the - key to scroll to the next figure and confirm with Enter

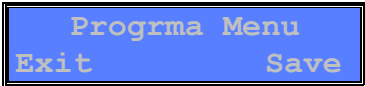
Press **Esc** to exit any menu and confirm the settings by pressing **Enter**.

<i>Display</i>	<i>Settings</i>
	Press the + and – keys to choose Save or NoSave, i.e. to save the settings or not and press Enter to confirm.

DISPLAY VIEW WITH THE SYSTEM ON STAND-BY

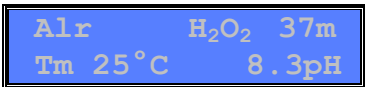
<i>Stand-by display</i>	<i>Operation</i>
	<p>The display is divided into 4 parts:</p> <ul style="list-style-type: none"> • On the upper left hand side the alarm is shown, when present. • On the upper right hand side three views are displayed: <ul style="list-style-type: none"> ○ The first is the stand-by system ○ The second shows the cc countdown dosed by the pump ○ The third is the waiting time until the next dosing with the message H₂O₂. • On the lower left hand side the temperature read by PT100 or manually set is shown. • On the lower right hand side the value read by the pH probe is shown
<p>1</p> 	
<p>2</p> 	
<p>3</p>	

*If Advanced→Flow=On and during H₂O₂ dosing, the recirculation pump stops and blocks the system dosing, when the pump restarts, the H₂O₂ will restart the cc dosing calculated from the start.

SHORTCUTS

To access the shortcut menu press the **SET** key for at least 3 seconds when the system is in stand-by.

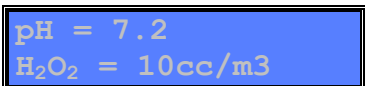
<i>Display Set</i>	<i>Operation</i>
	The pH- value flashes. It can be modified using the + and – keys and confirmed using Enter . For the H ₂ O ₂ value, repeat the same procedure, press Enter to confirm and exit.

9. DOSING METHOD

The control of the pumps in the pH scale is carried out through the PWM function. The proportional band is set to values pH= 0.8

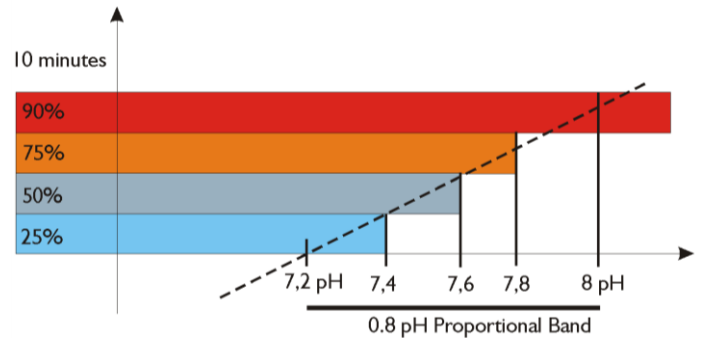

9.1 pH proportional dosing

The instrument allows the chemical measurement to be controlled and modified through the pH Set Point automatically; adjusting the dosing through the pH motor controlled in Proportional Time.

The dosing below is obtained by setting the following parameters:

- Set point pH = 7.20 pH
- Type of Dosing = Alkaline
- Proportional Band = 0.80 pH

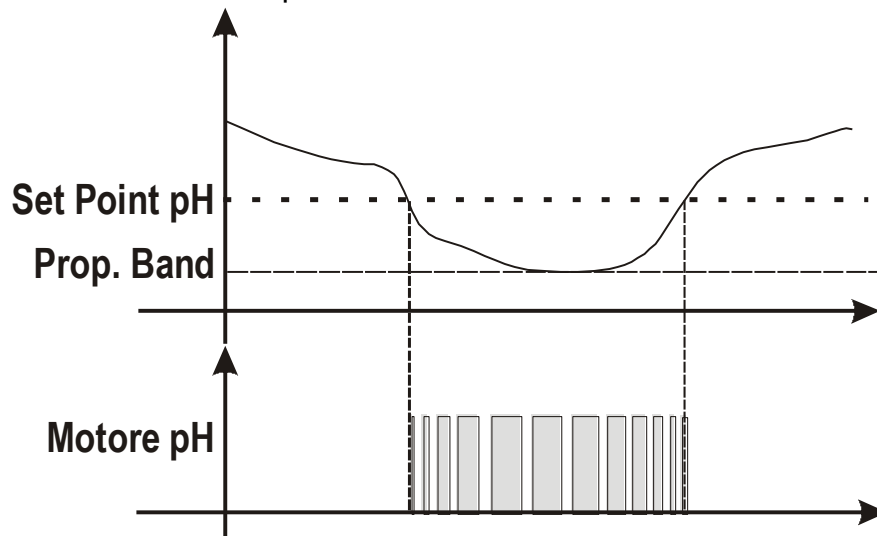

9.2 ON/OFF pH dosing

The instrument allows the chemical measurement to be controlled and modified through the pH Set Point automatically; adjusting the dosing through the pH motor controlled in ON/OFF.

The dosing below is obtained by setting the following parameters:

- Set point pH = 7.20 pH
- Type of Dosing = Alkaline

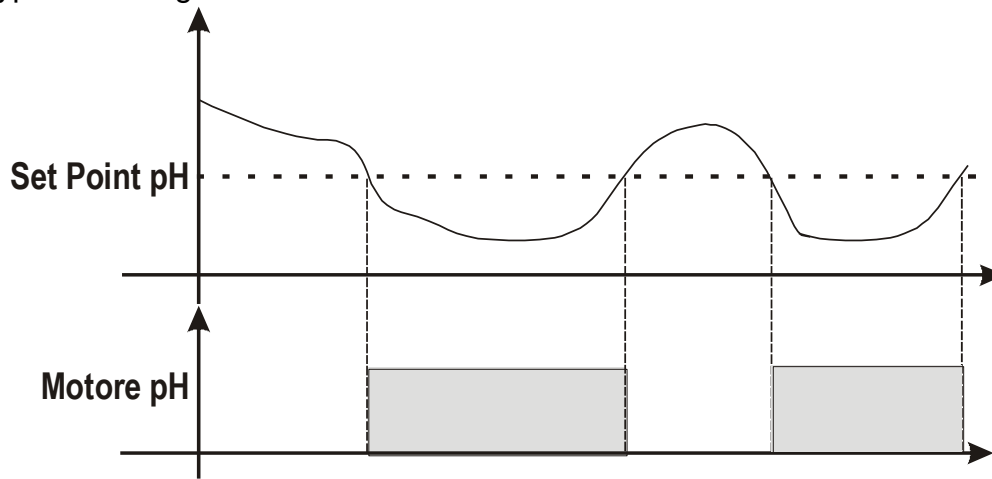

9.3 Alarm for the pH Set Point

When the alarm band is set, a work window is created. If the allowed limits are exceeded the alarm relay closes and remains closed until the measurement is reset or the enter key is pressed to deactivate the alarm.

When the OFA time (Over Feed Alarm) is set, the dosing time of Set Point pH in time is controlled with two alarms:

- First alarm at 70% of the time set is seen on the display, the alarm relay closes.
- Second alarm at 100% of the time set is seen on the display and the alarm relay closes and the pH motor is blocked.

Press the Enter key to eliminate the alarm and initialise the OFA time.

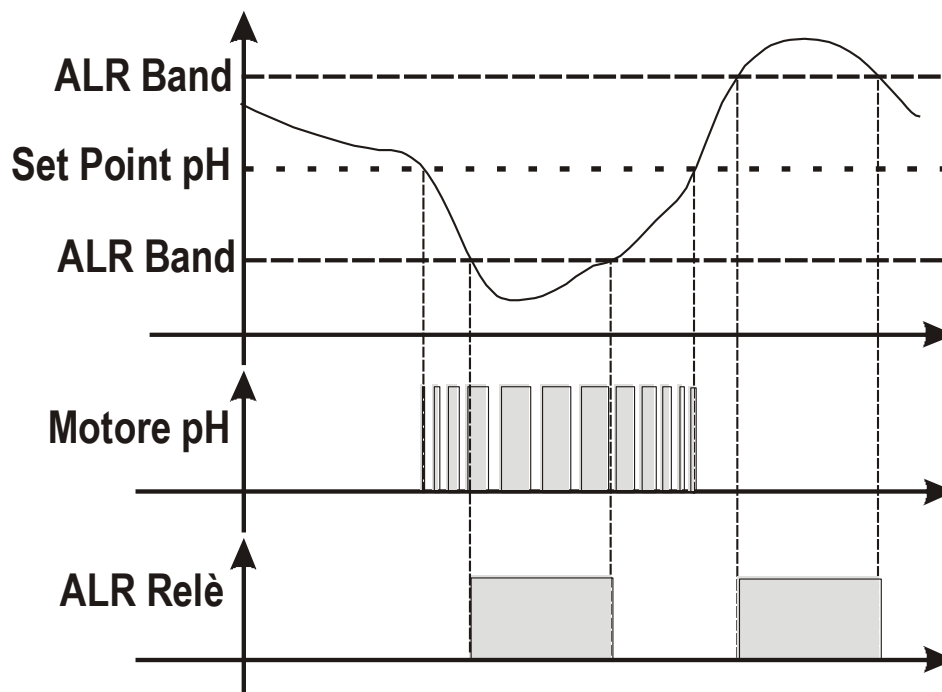

10. ACTIVATIONS

- **Flow Function**

Through the recirculation pump.

High voltage input 100 ÷ 240 Vac, the dosing system is switched on.

High voltage input is off (the recirculation pump is switched off), the dosing system shows FLOW flashing.

11. ALARMS

Lev pH= pH product level probe alarm.

Lev H₂O₂= Flocculant product level probe alarm.

OFA pH= Set Point not reached with the OFA time set*

pH Band= Shown when the value read is outside the SetPoint of +/- the band value set.

*At 70% of the time set the system shows and activates the alarm relay, at 100% it blocks the motor. Press the Enter key to reset the alarm.

Press the Enter key with the alarm active and its relay is deactivated only remaining shown on the display.

12. PRE-DEFINED CONTROL PARAMETERS

To reset default values and settings:

- Disconnect the device
- Hold down the + and – keys simultaneously and connect the device
- Confirm the choice to reset the default parameters

Default parameters:

- Language = **UK**
- Set Point = **7,4 pH; Acid; OFF; Alr Band 3,0 pH; PROP**
- H₂O₂ = **6x10; 1cc/m3; 20m3/h**
- Temperature = **25°C**
- Calibration = **FULL**
- Flow Input= **OFF**
- Password = **Disable**

13. LIST OF POSSIBLE ANOMALIES AND RELATIVE SOLUTIONS

ANOMALY	CAUSE	SOLUTION
The instrument always indicates pH 7.00	Problem with the cable and/or connector.	1) Check for possible short circuits on the electrode ↔ instrument connection cable (between the cable's core and the external shielding). 2) Make sure that there are no traces of humidity and/or condensation on the connector of the probe or the device. 3) Make sure that 100 Ω resistance is present between terminals 11 and 12.
The instrument always indicates a high or continuously unstable value	The electrode's connection cable is damaged.	Check the cable.
	There is an air bubble in the electrode's membrane.	Place the electrode vertically and shake it slightly until the air bubble rises. N.B.: The electrode must be vertical or tilted by a maximum of 45°.
	Electrode worn.	Replace the electrode.
	Connection cable too long or too close to an electrical wire: Disturbance.	Reduce the distance between the device and the probe.
Impossible to calibrate the pH 7 value	Unsuitable buffer solution.	Make sure that the solution used is pH 7.
		Check the buffer solution pH using an electronic pH-meter.
		Use a new pH 7 buffer solution and restart calibration.
Error shown on the display	Problem on probe's porous material, dirt deposits.	Make sure that the probe's porous material is in good condition; wash the electrode using a diluted acid-based solution and dry with a soft cloth.
Calibration quality of pH probe < 20%	Electrode worn.	Replace the electrode.
Impossible to calibrate the pH 4 value	Unsuitable buffer solution.	Make sure that the solution used is pH 4.
		Check the buffer solution pH using an electronic pH-meter.
		Use a new pH 4 buffer solution and restart calibration.
Error shown on the display	Problem with the electrode bulb.	Make sure that the electrode bulb is not damaged. Make sure that it did not become dry outside of the water. As a last resort, clean the electrode and leave it immersed in the water for a few hours.
Calibration quality of pH probe < 20%	Electrode worn.	Replace the electrode.
Slow electrode response	Electrode electrostatically charged.	During the calibration phase, the electrode MUST NOT be dried with a cloth or paper; let it drip.

14. HANDLING

Hose replacement:

①

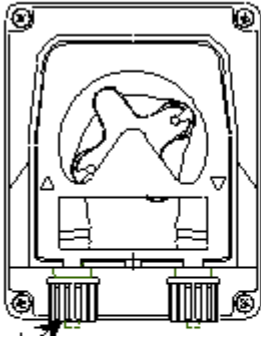

Release the cover by pulling the left connector upward.

②

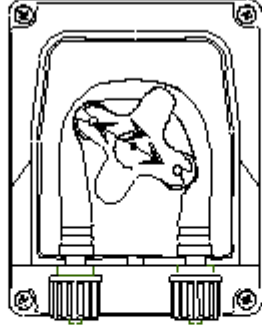

Position the roller at 20 past 10, turning it in the direction of the circular arrow.

③

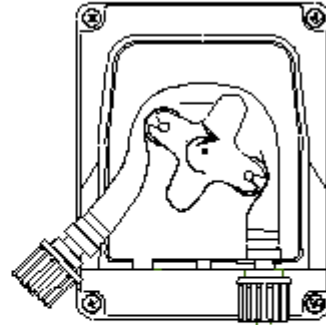

Completely release the left connector, holding it taut towards the outside, and turn the roller in the direction of the circular arrow so that the hose is freed up to the right connector.

④



Position the roller at 20 past 10, turning it in the direction of the circular arrow.

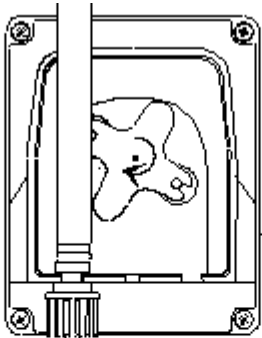

Insert the left connector into the relative housing and pass the hose under the roller's guide. Turn the probe holder in the direction of the circular arrow, simultaneously accompanying the hose into the pump's head, until the right connector is reached.

⑥

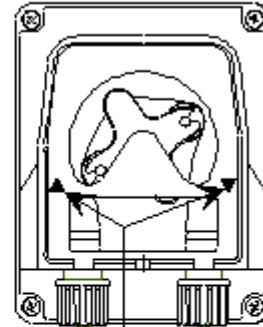

Arrows indicating the liquid's direction

Position the pump's cap, according to the direction of the arrows (▲▼) and press its surface hard so that it is properly locked into place.

15. STORING THE PUMP AFTER USE

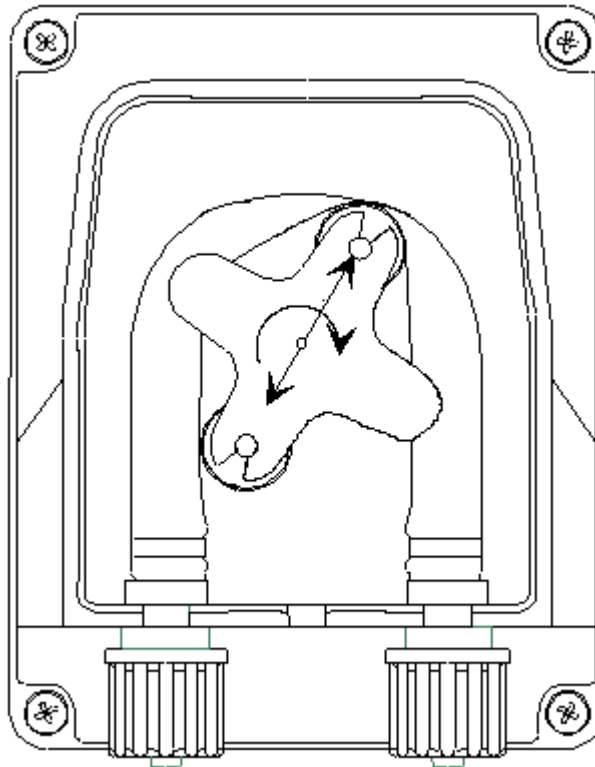

When the regulation device must be stored, clean water should be pumped through the hose in order to rinse it.

Then position the probe holder at 7h05, turning in the direction indicated by the circular arrow.

These two precautions will facilitate the subsequent reactivation of the unit.

WARNINGS

PRODUCTS TO BE USED:

- pH Reduction: product with a sulphuric acid base, easily found on the market.
- pH Increase: product with an alkaline acid base

PRODUCTS NOT RECOMMENDED

- Do not use hydrochloric acid.

Ask the installer about all other products.

PROBE WARNINGS

- Handle the probe with CARE.
- DO NOT INSERT AN EXCESSIVE AMOUNT of chemical product prior to the probe.
- Storing the probe: Extract the pH probe from the relative probe holder. Store it in the original bottle filled with tap water. If necessary, close the probe holder using a plug the size of a 5 euro cent coin.

Since the pH electrode consists of glass parts, handle it with care.
All of our electrodes are tested on the production line before being packaged.

Repairs of electrodes are not foreseen by the warranty unless they do not function when they are activated for the first time. Packaging not included.

In this case, in order for the probe to be accepted for examination, it absolutely must be sent in the original packaging with the relative bottle filled with water.

CAUTION: VAPOURS

