

# User manual

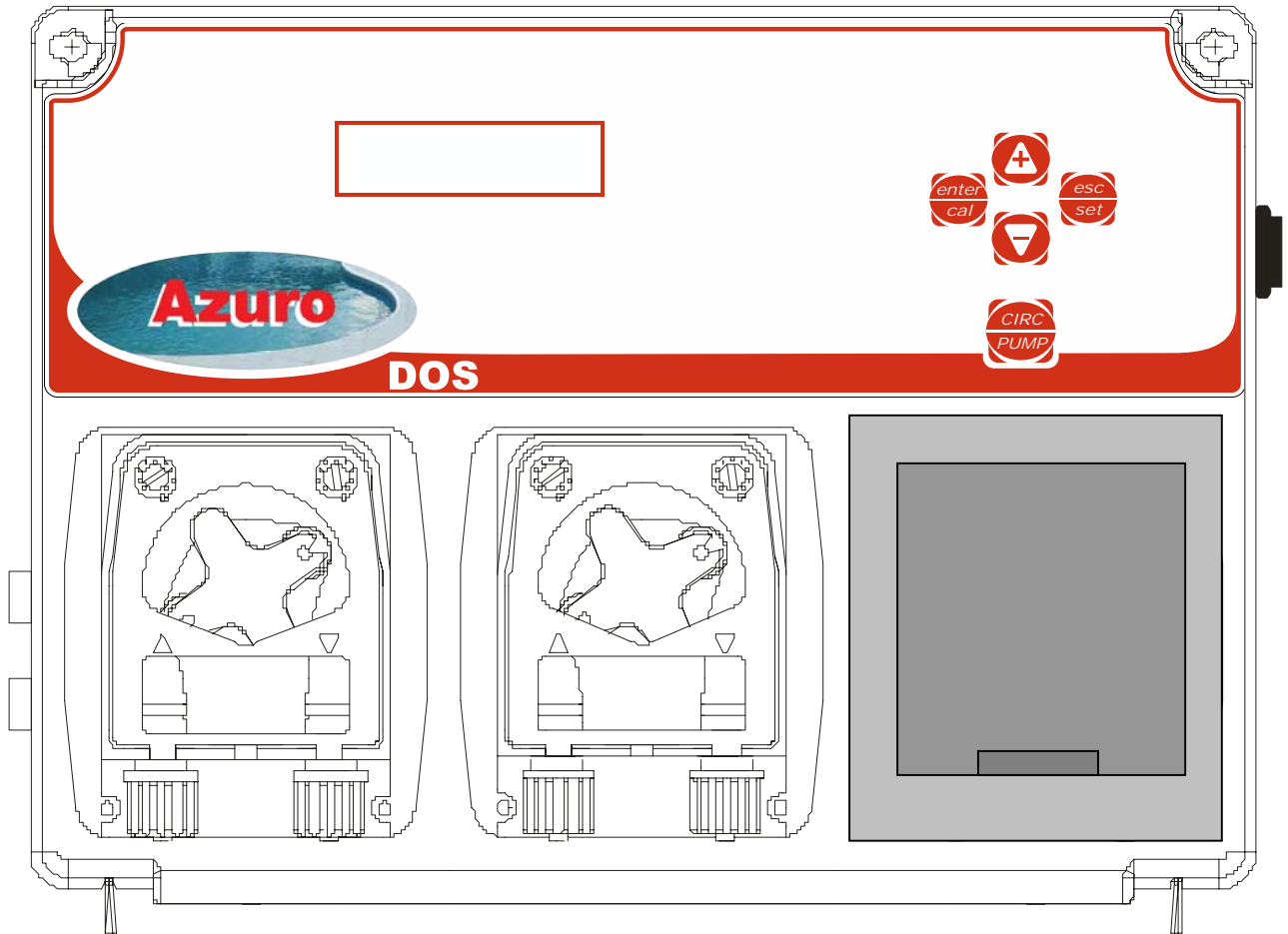

# INDEX

**1. GENERAL INTRODUCTION**

**2. INSTALLATION PRECAUTIONS**

**3. IDENTIFICATION OF THE COMPONENTS**

**4. TECHNICAL DATA**

**5. ASSEMBLY INSTRUCTIONS**

**5.1 EXAMPLE OF APPLICATION**

**6. DESCRIPTION OF THE CIRCUIT**

**7. CALIBRATION MENU**

**7.1 CALIBRATION**

7.1.1 Ph probe calibration

7.1.2 Redox probe calibration

7.1.3 Temperature calibration

**8. PROGRAMMING**

**9. DOSING METHOD**

**10. ACTIVATIONS**

**11. ALARMS**

**12. DEFAULT CONTROL PARAMETERS**

**13. LIST OF POSSIBLE ANOMALIES AND RELATIVE SOLUTIONS**

**14. HANDLING**

**15. STORING THE PUMP AFTER USE**

**WARNINGS**

## 1. GENERAL INTRODUCTION

The **Kommander EVO** regulation device belongs to the supplier's new line of precision instruments for innovative pool management. This easy to use device allows for pH levels to be constantly monitored.

The peristaltic pumps have a flow rate of 1.5 L/h for pH regulation and have a pressurised injection capacity of up to 1.5 bar.

This easy to use device requires no special maintenance. It features an automatic regulation procedure, as well as automatic electrode status verification.

## 2. INSTALLATION PRECAUTIONS

### ATTENTION !!!

**Disconnect the Kommander EVO device from the mains power supply before performing ANY operation inside its control panel.**

*FAILURE TO OBSERVE THE INSTRUCTIONS CONTAINED IN THIS MANUAL COULD RESULT IN PERSONAL INJURY AND/OR DAMAGE TO THE DEVICE.*

### CAUTION

When installing the **Kommander EVO** device, proceed in the following manner:

- Make sure that the Power Supply voltage coincides with that which is indicated on the label on the side of the device.
- Make sure that the injection pressure is less than 1.5 bar.
- Make sure that the pump's protective cover is properly attached.
- Make sure that the suction tube is immersed, with the relative foot (PVC tube) in the tank containing the product to be injected, and is connected to the pump (symbol on the cover ▲). After having performed this check, tighten the nut on the fitting.
- Connect one end of the delivery pipe to the pump (symbol on the cover ▼) and connect the other end to the pool by means of the injection valve.

**N.B.:** Use the appropriate button to switch to forced pump running mode in order to insert the product to be injected into the pump upon first activation and when changing the tank.

### 3. IDENTIFICATION OF THE COMPONENTS

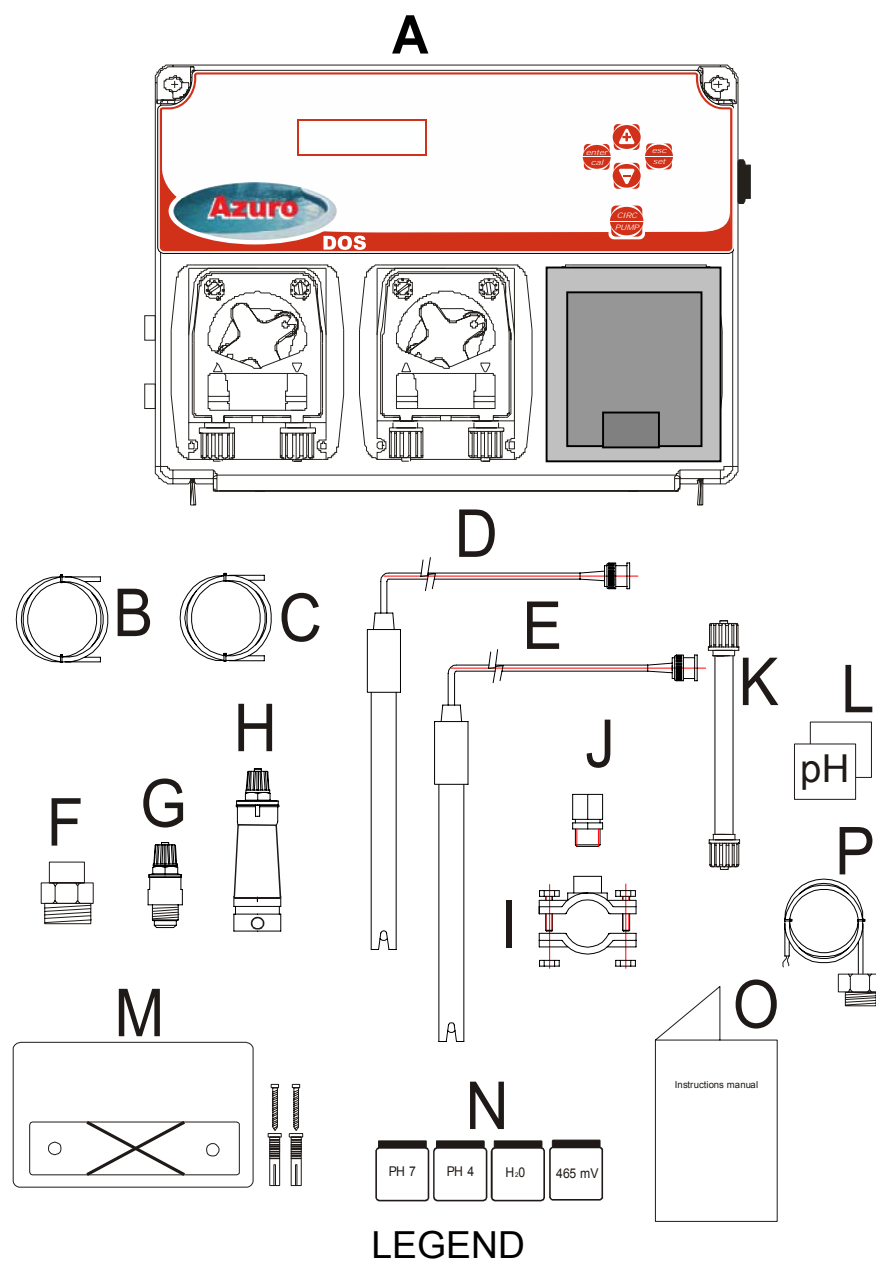

- A. Kommander EVO regulator**  
**B. 4x6 (4 m) x 3 Crystal PVC suction tube**  
**C. 4x6 (5 m) x 3 PE delivery pipe**  
**D. pH Electrode model SPH-1**  
**E. Redox electrode**  
**F. Reduction for injector valve x 2 (not included)**  
**G. FPM lip valve (3/8" GAS) x 3**  
**H. Suction foot filter (PVC tube) x 3**  
**I. Clamp for fastening the PSS3 or the valve upon 2" pipe  $\phi=50\text{mm}$  x5 (not included)**  
**J. PSS3 probe holder (1/2" GAS) x 2 (not included)**  
**K. 3x7 tube for flocculant**  
**L. Label to be applied to the pumps**  
**M. Fastening bracket kit**  
**N. Buffer solution kit pH 4, pH 7, H<sub>2</sub>O, 465 mV**  
**O. Instruction manual**  
**P. Temperature sensor**

## 4. TECHNICAL DATA

- **Power supply:** 100-240 Vac 50/60 Hz 30 watt
- **Switch:** edge of the box
- **Input measurements:** pH and Redox, through BNC
  - pH scale: 0-14.0 pH
  - pH precision: +/-0.1 pH
  - Redox scale: 0-1500mV
  - Redox precision: +/-10 mV
- **Temperature scale:** 0-100 °C (PT100 sensor)
- **Pump flow rate** with transaxle technology:
  - **pH, Redox:** 1.5 l/h (6X10 tube) 1.5 bar
  - **Plug for circulation pump Maximum power 1500 Watt**
- **Recirculation pump relay output:** 230 Vac 1.5 Kw
- **Pump alarm relay:** 10 A 250 V (Dry contact)
- **Boiler relay output:** 230 Vac 1.5 Kw
- **Power Supply dedicated to the pumps:** 240 Vac 10 watt
- **Input signal:** 100÷240 Vac
- **Level probe:** pH, Redox, Flocculant

Install the **Kommander EVO** regulator upon a rigid support (vertical wall) in a location which can be easily accessed by the operator. Use the fastening bracket supplied along with the kit to fix the **Kommander EVO** regulator in place (distance between the holes of the bracket: 95 mm. Hole Ø 6).

Before performing any operations inside the device, make sure that the switches are in their 0 positions. Turn the two screws on the upper portion of the device  $\frac{1}{4}$  of a turn to allow the front portion to open on its hinges.

## 5. ASSEMBLY INSTRUCTIONS

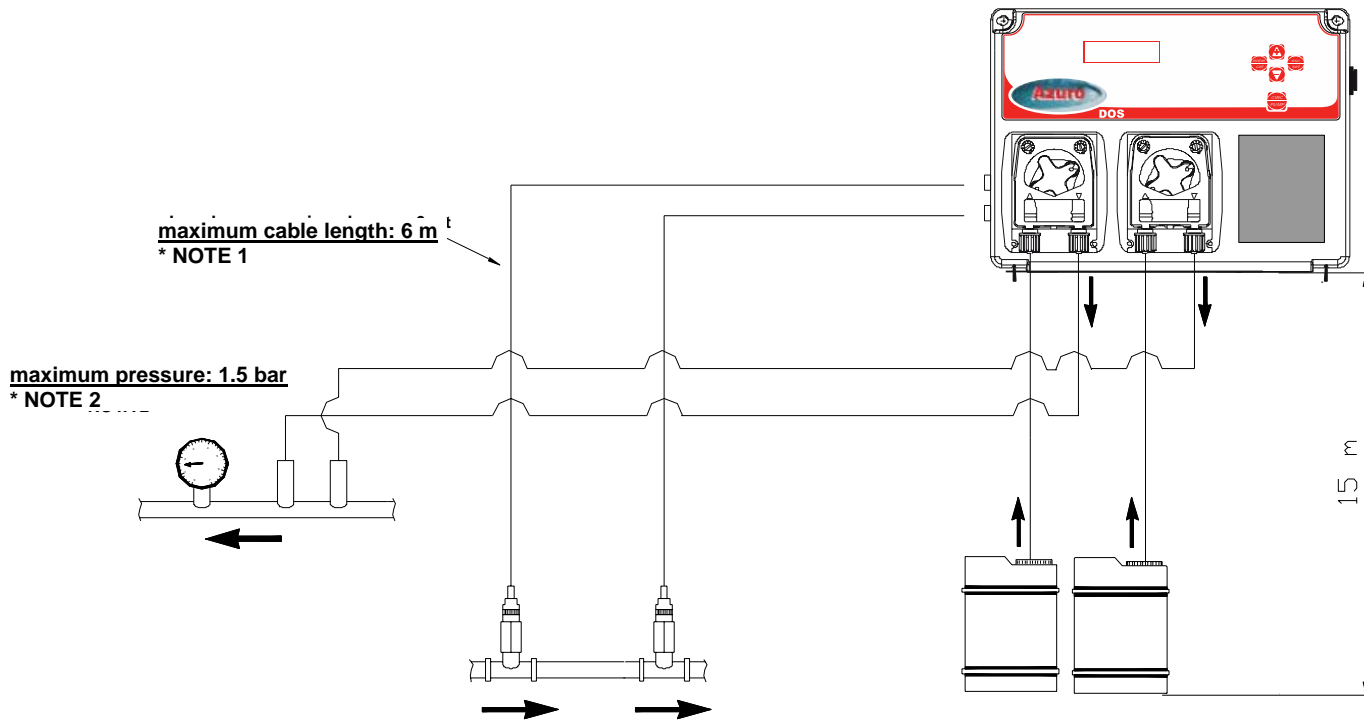

\* NOTE 1: IN ORDER TO AVOID ELECTRICAL DISTURBANCES, THE CABLE MUST PASS THROUGH A ZONE OTHER THAN THOSE USED FOR POWERING LARGE PUMPS.

\* NOTE 2: THE MAXIMUM PRESSURE MUST NOT EXCEED 1.5 BAR.  
IN ORDER TO ALLOW FOR INCREASED TUBE DURATION, THE PRESSURE MUST NOT EXCEED 1 BAR.

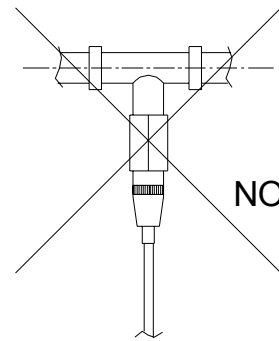
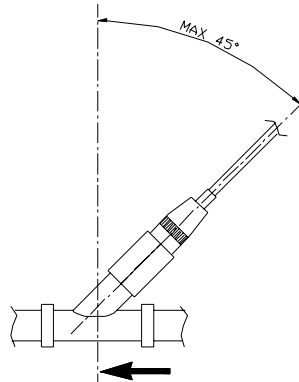
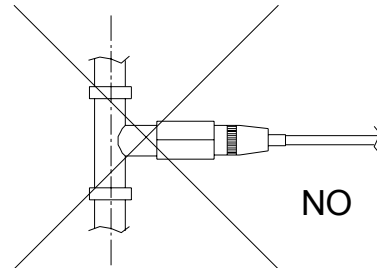
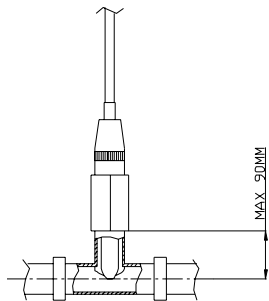

## 5.1 EXAMPLE OF APPLICATION

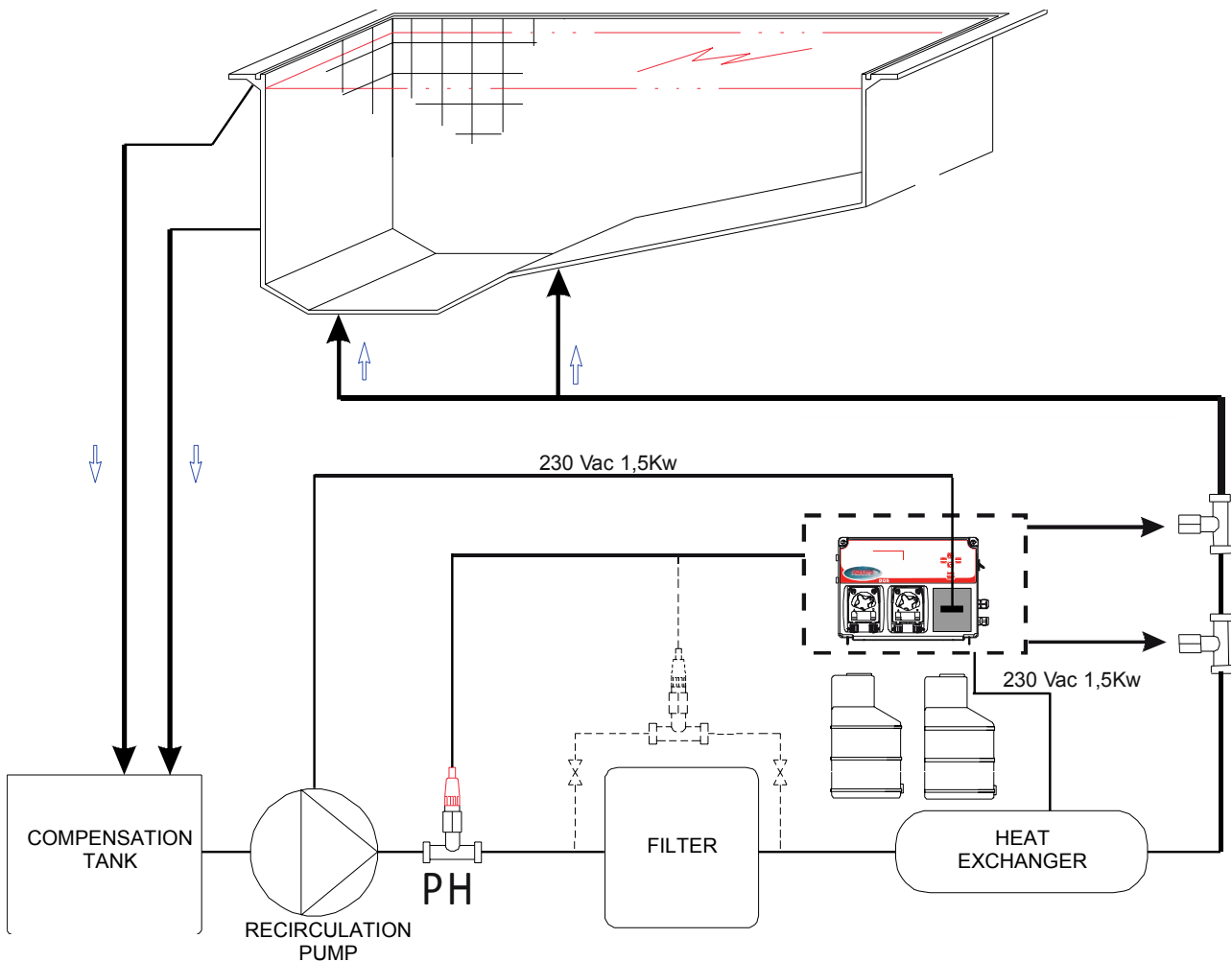

### Note 1:

The linear distance of the channelling between the probe and the injection point must not be less than 60 cm.

**Note 2:** Manually activation use “Cir pump” circulation key button. It is possible to power on the circulation pump on demand, the function is not available while circulation pump is running accordingly to weekly timer.

## 6. DESCRIPTION OF THE CIRCUIT

- 1) PH measurement input
- 2) Redox measurement input
- 3) Temperature probe input
- 4) pH product level probe input
- 5) Redox product level probe input
- 6) Flocculant product level probe input
- 7) Keyboard input
- 8) Flow (recirculation pump)
- 9) Alarm relay (dry contact)
- 10) 240 Vac power supply input
- 11) Recirculation pump relay output 240 Vac 10A
- 12) 10A fuse
- 13) Boiler relay output 240 Vac 10A
- 14) Flocculant pump power supply
- 15) Redox pump power supply
- 16) pH pump power supply

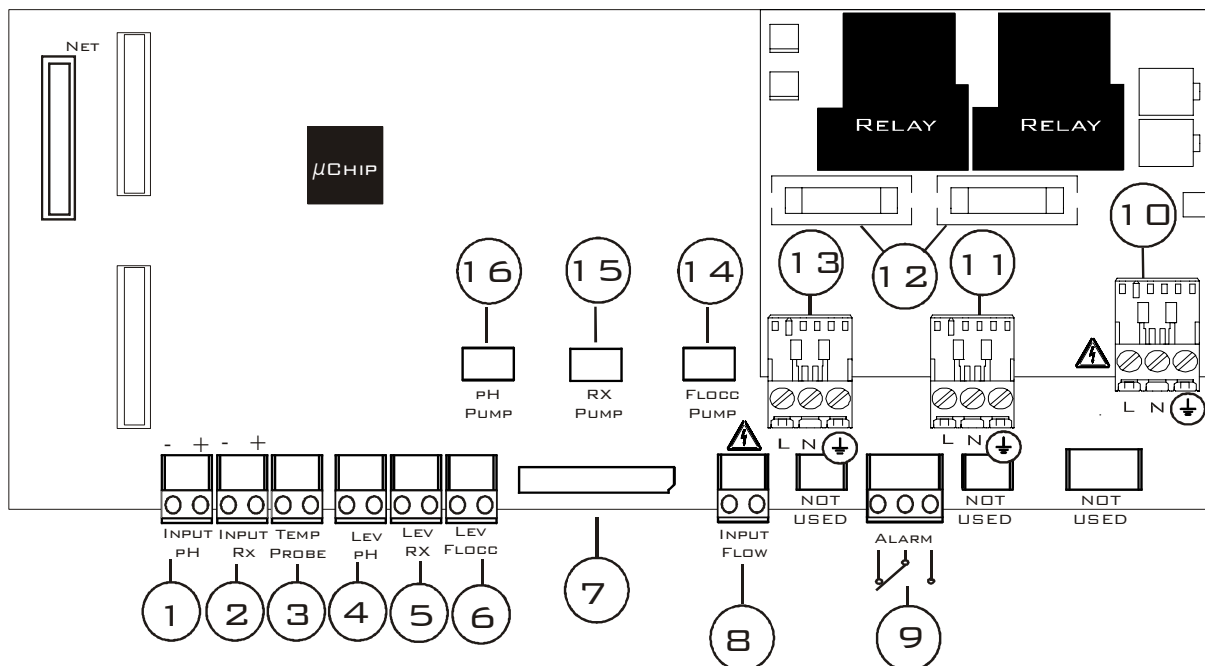



## DISPLAY MODES WITH THE SYSTEM IN STAND-BY

A = Up Key  
 B = CAL/Enter Key  
 C = SET/Esc Key  
 D = Down Key  
 E = Display  
 F = Circulation Pump

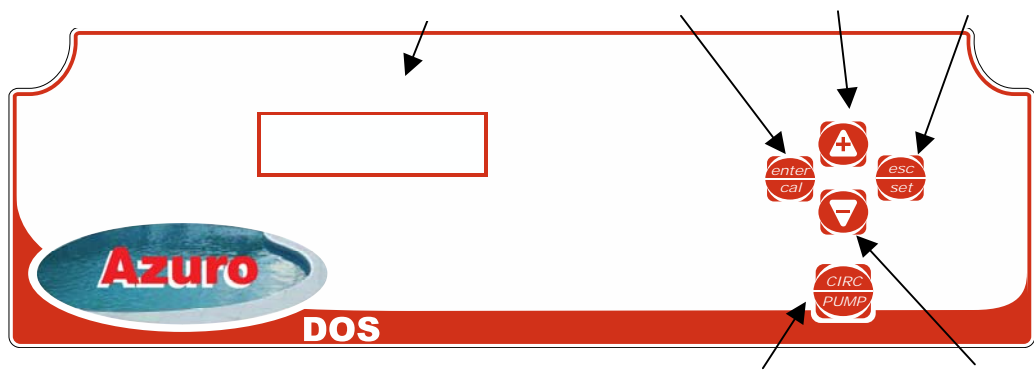

Press the **Down** and **SET** keys simultaneously to change the display mode. The two display modes are illustrated and described below:

	<b>Stand-by Display Mode 1</b>	<b>Functionality</b>
1		The display is divided into 4 parts: <ul style="list-style-type: none"> <li>• When active, the alarm is shown on the upper left.</li> <li>• Three elements are displayed on the upper right:                             <ul style="list-style-type: none"> <li>○ The 1<sup>st</sup> is the display mode with the system in stand-by.</li> <li>○ The 2<sup>nd</sup> displays the countdown of the amount being dosed by the pump in cc.</li> <li>○ The 3<sup>rd</sup>, with the message FLOC, is the expected time until the next dose.</li> </ul> </li> <li>• The value detected by the Rx probe is displayed on the lower left.</li> <li>• The value detected by the pH probe is displayed on the lower right.</li> </ul>
2		
3		

\*If Advanced→Flow= On and the recirculation pump stops during Flocculant dosing, thereby blocking the dosing of the system, once the pump is reactivated the Flocculant will restart the calculated dose in cc from the beginning.

**N.B.** The recirculation pump can be connected to the system. This function can be used when the system does not control the pump through a relay, but the signal comes from an autonomous pump.

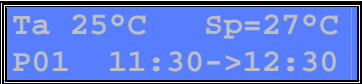

<b>Stand-by Display Mode 2</b>		<b>Functionality</b>
1		<p>The display is divided into 4 parts (Fig.1):</p> <ul style="list-style-type: none"> <li>• The temperature value detected by the probe is displayed on the upper left.</li> <li>• The SetPoint of the boiler is displayed on the upper right. When the relay is active, the value is flashing.</li> <li>• The day of the week is displayed on the lower left.</li> <li>• The clock is displayed on the lower right.</li> </ul> <p>When a program for the recirculation pump is activated, the program number, with the start and stop times flashing, is displayed on the bottom line. (fig. 2)</p>
2		

**N.B.** If an alarm should occur, the system will automatically switch to Stand-by display mode 1, thereby displaying the alarm typology.

## 7. CALIBRATION MENU







### 7.1 Calibration

Before continuing, calibration must be enabled. Select **Advanced**→**Cal** from the menu. The display will show:

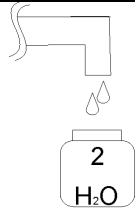
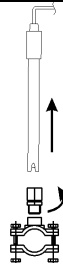
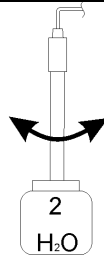
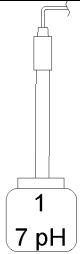
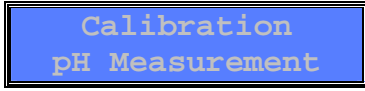



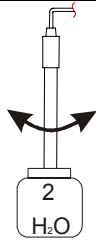

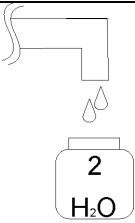
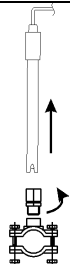
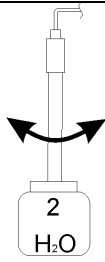
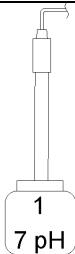
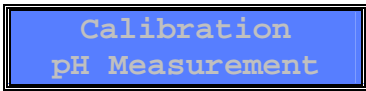

<b>Calibration Menu Display</b>	<b>Settings</b>
	Press <b>ENTER</b> to access the menu.
	<p>Press <b>Enter</b> and use the + and - keys to modify the calibration settings:</p> <ul style="list-style-type: none"> <li>• <b>Full:</b> The system calibrates the reading of the pH probe's value based on 2 reference values (7 and 4 pH). This calibration mode allows the system to read the values with greater precision.</li> <li>• <b>Easy:</b> The system calibrates the reading of the pH probe's value based on one reference value (7 pH).</li> <li>• <b>Off:</b> Calibration is disabled.</li> </ul>

Exit the menu and return to the system's normal status.

### 7.1.1 pH probe calibration (Easy)

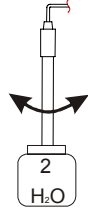
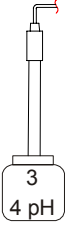

 <p><b>1</b> Collect some water</p>	 <p><b>2</b> Remove the probe from the probe holder</p>	 <p><b>3</b> Wash the probe</p>
 <p><b>4</b> Place the probe in the 7 pH buffer solution</p>	 <p><b>5</b> Press the <b>Cal</b> button for 3 seconds and use the same button to confirm the pH Measurement</p>	 <p><b>6</b> Press <b>Cal</b> to start the calibration with a pH 7 buffer solution</p>
 <p><b>7</b> The calibration has a duration of 1 minute</p>	 <p><b>8</b> Probe quality</p>	 <p><b>9</b> Wash the probe</p>
 <p><b>10</b> Put the probe back in the probe holder and press <b>Cal</b> to end the procedure</p>		

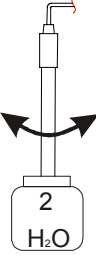
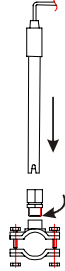
### 7.1.1 pH probe calibration (Full)

<p>①  Collect some water</p>	<p>②  Remove the probe from the probe holder</p>	<p>③  Wash the probe</p>
<p>④  Place the probe in the 7 pH buffer solution</p>	<p>⑤  Press the <b>Cal</b> button for 3 seconds and use the same button to confirm the pH Measurement</p>	<p>⑥  Press <b>Cal</b> to start the calibration with a pH 7 buffer solution</p>
<p>⑦  The calibration has a duration of 1 minute</p>	<p>⑧  Probe quality</p>	<p>⑨  Wash the probe</p>
<p>⑩  Place the probe in the 4 pH buffer solution</p>	<p>⑪  Press <b>Cal</b> to start the calibration with a pH 4 buffer solution</p>	<p>⑫  The calibration has a duration of 1 minute</p>
<p>⑬  Probe quality</p>	<p>⑭  Wash the probe</p>	<p>⑮  Put the probe back in the probe holder and press <b>Cal</b> to end the procedure</p>

### 7.1.1 Redox probe calibration

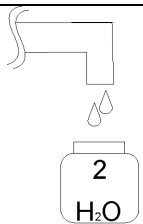
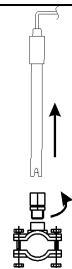
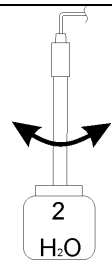
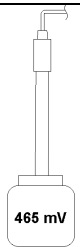
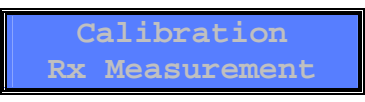
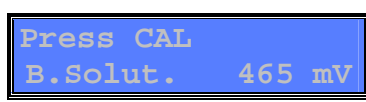
In order to perform this calibration, Redox measurement must be enabled

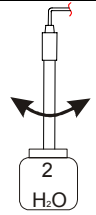
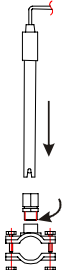
 <p><b>1</b> Collect some water</p>	 <p><b>2</b> Remove the probe from the probe holder</p>	 <p><b>3</b> Wash the probe</p>
 <p><b>4</b> Place the probe in the 465 mV buffer solution</p>	 <p><b>5</b> Press the <b>Cal</b> button for 3 seconds and use the same button to confirm the Rx Measurement</p>	 <p><b>6</b> Press <b>Cal</b> to start the calibration with a 465 mV buffer solution</p>
 <p><b>7</b> The calibration has a duration of 1 minute</p>	 <p><b>8</b> Probe quality</p>	 <p><b>9</b> Wash the probe</p>
 <p><b>10</b> Put the probe back in the probe holder and press <b>Cal</b> to end the procedure</p>		

### 7.1.4 Temperature calibration

This function is only present if a temperature probe is connected.

This operation allows the probe to provide an even more precise reading wherever necessary.

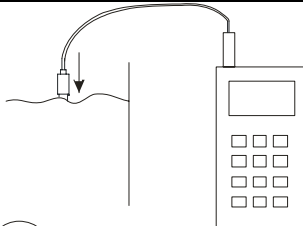
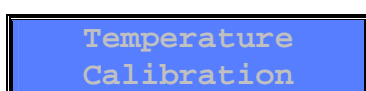
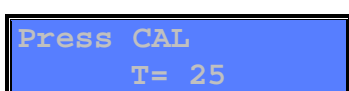
 <p><b>1</b> Use a portable instrument or a simple thermometer to measure the temperature of the water</p>	 <p><b>2</b> Press the <b>Cal</b> button for 3 seconds and use the same button to confirm the Temperature</p>	 <p><b>3</b> Use the <b>Up</b> and <b>Down</b> buttons to insert the detected temperature value and press the <b>CAL</b> button to confirm.</p>
---	--	---

## 8. PROGRAMMING

Press the **Cal** and **Set** buttons simultaneously for at least 3 seconds to access the programming menu.

After releasing the buttons, the display will show:



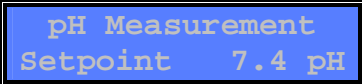
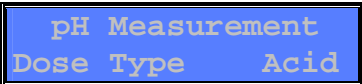
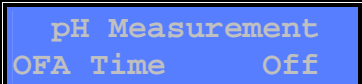
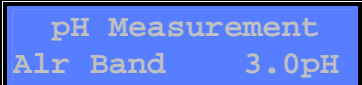
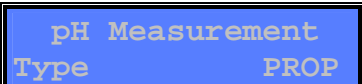

<i>Display Language</i>	<i>Settings</i>
	Press <b>Enter</b> and use the + and - keys to change the selected language: FR, EN, IT, ES, DE

To prime the **pH** pump, press the **UP** button for at least 3 seconds and release it to complete the operation. Follow the same procedure using the **DOWN** button to prime the **Rx** pump and using the **UP** and **DOWN** buttons simultaneously to prime the **Flocculant** pump.

<i>pH Measurement Display</i>	<i>Settings</i>
	Press <b>Enter</b> to access the submenus: <ul style="list-style-type: none"> <li>• Setpoint</li> <li>• Dose type</li> <li>• OFA time</li> <li>• Alr Band</li> <li>• Type</li> </ul>
	Press <b>Enter</b> and use the + and - keys to modify the Set Point value (0-14 pH)
	Press <b>Enter</b> and use the + and - keys to modify the Set Point typology: <ul style="list-style-type: none"> <li>• Acid</li> <li>• Alkaline</li> </ul>
	Press <b>Enter</b> and use the + and - keys to set the OFA time to OFF or to a value between 1 and 240 min. (See section 9.5)
	Press <b>Enter</b> and use the + and - keys to set the band alarm to a value between 1 and 3 pH.
	Press <b>Enter</b> and use the + and - keys to modify the dose type: <ul style="list-style-type: none"> <li>• PROP (See Section 9.2)</li> <li>• ON/OFF (See Section 9.4)</li> <li>• OFF (Dose disabled)</li> </ul>





<b>Rx Measurement Display</b>	<b>Settings</b>
<div style="border: 1px solid black; padding: 5px; text-align: center;">           Menu Rx Measurement         </div>	Press <b>Enter</b> to access the submenus: <ul style="list-style-type: none"> <li>• Setpoint</li> <li>• Dose type</li> <li>• OFA Time</li> <li>• Alr Band</li> <li>• Type</li> </ul>
<div style="border: 1px solid black; padding: 5px; text-align: center;">           Rx Measurement Setpoint 760mV         </div>	Press <b>Enter</b> and use the + and - keys to modify the Set Point value (0-1500 mV)
<div style="border: 1px solid black; padding: 5px; text-align: center;">           Rx Measurement Dose Type High         </div>	Press <b>Enter</b> and use the + and - keys to modify the Set Point typology: <ul style="list-style-type: none"> <li>• High</li> <li>• Low</li> </ul>
<div style="border: 1px solid black; padding: 5px; text-align: center;">           Rx Measurement OFA Time Off         </div>	Press <b>Enter</b> and use the + and - keys to set the OFA time to OFF or to a value between 1 and 240 min. (See section 9.5)
<div style="border: 1px solid black; padding: 5px; text-align: center;">           Rx Measurement Alr Band 300mV         </div>	Press <b>Enter</b> and use the + and - keys to set the band alarm to a value between 100 and 300 mV.
<div style="border: 1px solid black; padding: 5px; text-align: center;">           Rx Measurement Type PROP         </div>	Press <b>Enter</b> and use the + and - keys to modify the dose type: <ul style="list-style-type: none"> <li>• PROP (See Section 9.2)</li> <li>• ON/OFF (See Section 9.4)</li> <li>• OFF (Dose disabled)</li> </ul>

<b>Flocculant Measurement Display</b>	<b>Settings</b>
<div style="border: 1px solid black; padding: 5px; text-align: center;">           Menu Flocculant         </div>	Press <b>Enter</b> to access the submenus: <ul style="list-style-type: none"> <li>• Tube</li> <li>• Conc</li> <li>• Pump</li> <li>• Type</li> </ul>
<div style="border: 1px solid black; padding: 5px; text-align: center;">           Flocculant Tube 6x10         </div>	Press <b>Enter</b> to modify the dimensions of the tube (3x7 or 6x10 mm). The system will automatically calculate the flow rate for the selected tube with no need to modify any other parameters (by default the system uses the 6x10 tube).
<div style="border: 1px solid black; padding: 5px; text-align: center;">           Flocculant Conc 1.0 cc/m3         </div>	Insert the desired product concentration value to be dosed. This value can be set between 1 and 4 cc/m <sup>3</sup> with the 3x7 tube, or between 1 and 15 cc/m <sup>3</sup> with the 6x10 tube.
<div style="border: 1px solid black; padding: 5px; text-align: center;">           Flocculant Pump 20 m3/h         </div>	Insert the value associated with the system's recirculation pump. This value can be set between 2 and 100 m <sup>3</sup> /h.
<div style="border: 1px solid black; padding: 5px; text-align: center;">           Flocculant Type ON/OFF         </div>	Press <b>Enter</b> and use the + and - keys to enable (ON/OFF) or disable (OFF) the dosing.

<b>Boiler Display</b>	<b>Settings</b>
 <p>Menu Boiler</p>	Press <b>Enter</b> to access the submenus: <ul style="list-style-type: none"> <li>• Setpoint</li> <li>• Type</li> <li>• OFA Time</li> </ul>
 <p>Boiler Setpoint 25°C</p>	Press <b>Enter</b> and use the + and – keys to modify the Set Point value (15-60 °C), or rather the value at which the relay opens or closes based on the <b>Dose Type</b> settings.
 <p>Boiler Type High</p>	Press <b>Enter</b> and use the + and - keys to modify the Set Point typology: <ul style="list-style-type: none"> <li>• <b>High</b>: the relay is active until the Set Point temperature is reached. The activation is present for temperatures higher than the Set Point value.</li> <li>• <b>Low</b>: the relay is active until the Set Point temperature is reached. The activation is present for temperatures lower than the Set Point value.</li> </ul>
 <p>Boiler OFA Time Off</p>	Press <b>Enter</b> and use the + and - keys to set the OFA time to OFF or to a value between 1 and 240 min. This is the time for which the relay will be disabled if the temperature detected by the probe does not reach the Set Point value.

\* if the temperature probe is not present, the display will show an Error message upon accessing the menu. This menu item is only enabled if a temperature probe is connected.







Recirculation Pump Display	Settings
	Press <b>Enter</b> to access the programming submenus. This menu item allows for up to 10 different weekly programs to be configured with a start and stop time. The configured program activates an output relay with a voltage of 220 VAC for powering an external device.
	Use the + and – keys to set the desired program (P01....P10).
	Press <b>Enter</b> to set the relay’s activation time. Use the + and – keys to modify the flashing hour values 00...24 and press <b>Enter</b> to confirm. Use the + and – keys to modify the flashing minute values 00...59 and press <b>Enter</b> to confirm.
	Press the – key to access the submenu for setting the relay’s deactivation time. Press <b>Enter</b> to modify the time. Use the + and – keys to modify the flashing hour values 00...24 and press <b>Enter</b> to confirm. Use the + and – keys to modify the flashing minute values 00...59 and press <b>Enter</b> to confirm.
	The program can be configured for activation on various days of the week, using the <b>Enter</b> button to apply the modified parameters. The days of the week are indicated on the upper portion of the display as a reference, with an X below to indicate that the relative day has been enabled. Use the – key to scroll through the days and the + key to enable or disable the selected day. Press <b>Enter</b> to confirm the parameters.

\* If a relay activation program that overlaps two consecutive days is required (ex. Start: 22:30: Stop: 01:30 of the following day), two consecutive programs must be configured.

Ex.

**P01** - Start: 22:30; End: 23:59

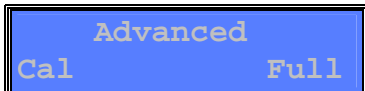
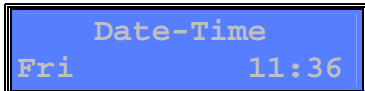
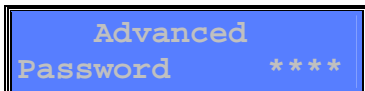
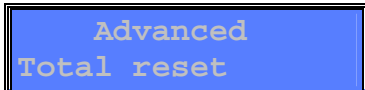
**P02** - Start: 00:00; End: 01:30 (of the following day).

<b>Advanced Display</b>	<b>Settings</b>
	Press <b>Enter</b> to access the submenus: <ul style="list-style-type: none"> <li>• Temp.</li> <li>• Flow</li> <li>• Cal</li> <li>• Date-Time</li> <li>• Password</li> <li>• Total reset</li> <li>• Enable boiler</li> <li>• Enable r. pump</li> </ul>
	Press <b>Enter</b> and use the + and - keys to set the compensation temperature to a value from 1 to 100 °C. If a temperature probe is connected, this menu item will not be displayed and the system will automatically compensate based on the value detected by the probe.
	Press <b>Enter</b> and use the + and - keys to set the flow to OFF or ON. This menu item enables or disables the <b>Flow</b> input. (See Section 10.0).
	Press <b>Enter</b> and use the + and - keys to modify the calibration settings: <ul style="list-style-type: none"> <li>• <b>Full</b>: The system calibrates the reading of the pH probe's value based on 2 reference values (7 and 4 pH). This calibration mode allows the system to read the values with greater precision.</li> <li>• <b>Easy</b>: The system calibrates the reading of the pH probe's value based on 1 reference value (7 pH).</li> <li>• <b>Off</b>: Calibration is disabled.</li> </ul>
	Press <b>Enter</b> to set the time and the day of the week. The reference value will flash. Use the + and - keys to make any desired changes and press <b>Enter</b> to confirm.
	Press <b>Enter</b> to set the security password for accessing and modifying the system's parameters. Use the + key to modify the selected value, the - key to move on to the next character and the <b>Enter</b> key to confirm.
	Press <b>Enter</b> to reset the system's settings. Press <b>Enter</b> again to confirm the reset operation (the system's default parameters will be loaded).
	Press <b>Enter</b> and use the + and - keys to enable (Yes) or disable (No) the boiler relay's output.
	Press <b>Enter</b> and use the + and - keys to enable (Yes) or disable (No) the recirculation pump relay's output.

Press **Esc** to exit the various menus and **Enter** to confirm the settings.

<i>Display</i>	<i>Settings</i>
	Use the + and – keys to select YES or NO, indicating whether or not to save the settings. Press <b>Enter</b> to confirm the operation.

### HOTKEYS

With the system in stand-by, press the **SET** button for at least 3 seconds to access a quick setup menu:

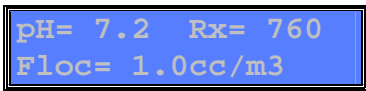
<i>Set Display</i>	<i>Functionality</i>
	The pH value flashes. Use the + and – keys to make any desired modifications and press <b>Enter</b> to continue and move on to the Rx or Flocculant value. Continue using the same procedure, pressing <b>Enter</b> to confirm and exit.

## 9. DOSING METHOD

The control of the pumps in the pH and Redox scale takes place by means of a PWM function.

The proportional band is fixed on the values: pH = 0.8 and Redox = 120 mV

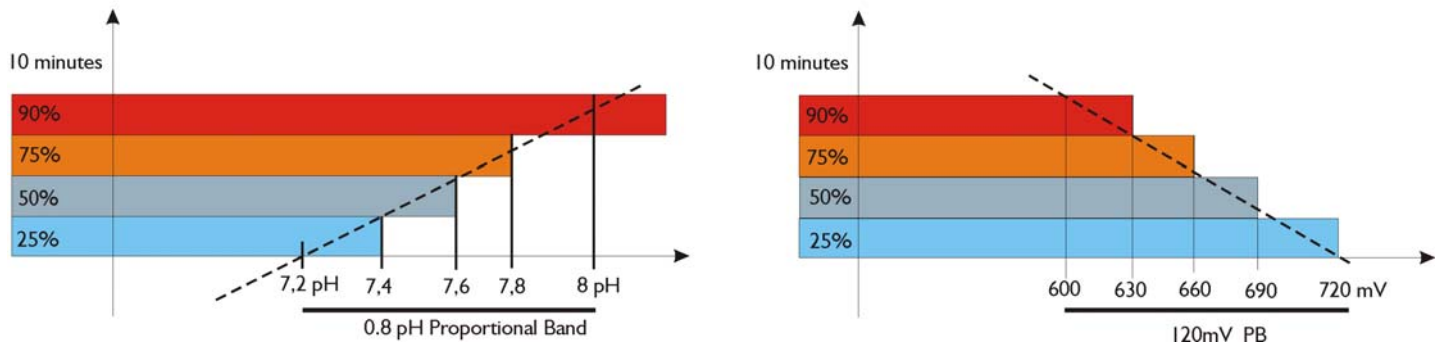

### 9.1 pH/Redox Proportional Dosing

The instrument allows for the chemical measurement to be modified and monitored automatically through the pH Set Point, adjusting the dose through the pH/Redox motor commanded in Proportional Time mode.

The dosage indicated below can be obtained by setting the following parameters:

- pH Set point = 7.20 pH
- Dose type = Alkaline
- Proportional Band = 0.80 pH

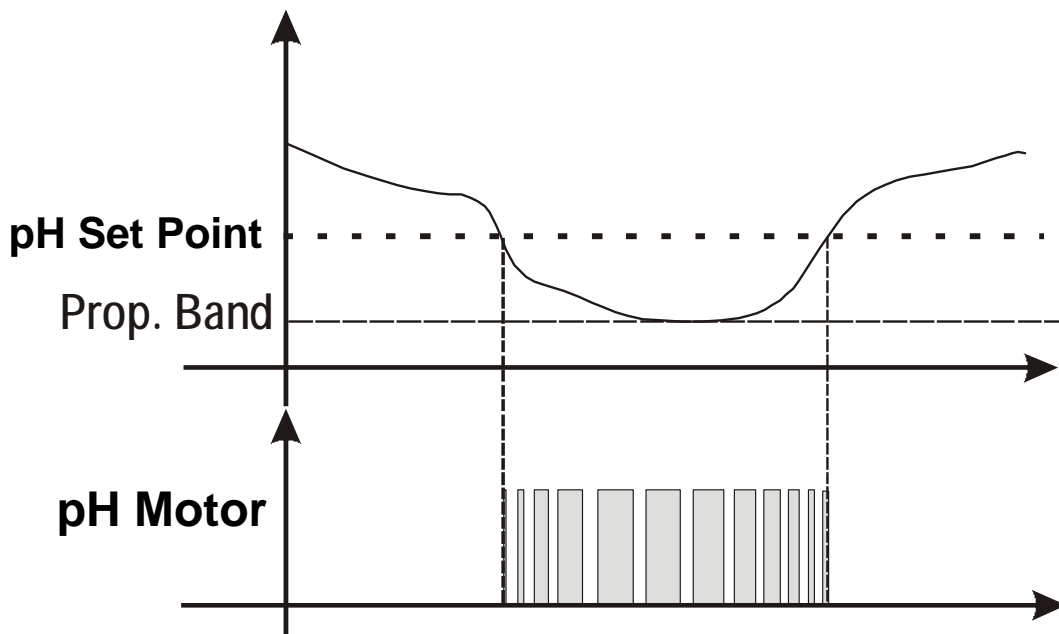

## 9.2 pH/Redox ON/OFF Dosing

The instrument allows for the chemical measurement to be modified and monitored automatically through the pH Set Point, adjusting the dose through the pH motor commanded in ON/OFF mode.

The dosage indicated below can be obtained by setting the following parameters:

- pH Set point = 7.20 pH
- Dose type = Alkaline

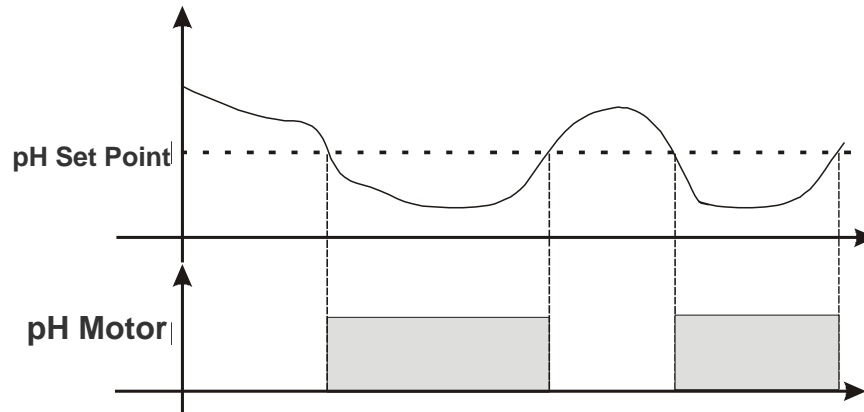

## 9.3 pH/Redox Set Point Alarm

By configuring the Band alarm, a working window is created. If the configured limits are exceeded, the alarm relay closes and remains closed until the measurement is restored or until the enter key is pressed to deactivate the alarm.

By configuring the OFA (Over Feed Alarm) time, the dose of the pH/Redox Set Point is monitored over time, divided into two alarms:

- At 70% of the set time the first alarm is shown on the display and the alarm relay closes.
- At 100% of the set time the second alarm is shown on the display, the alarm relay closes and the pH/Redox motor shuts down.

Press Enter to cancel the alarm and initiate the OFA time.

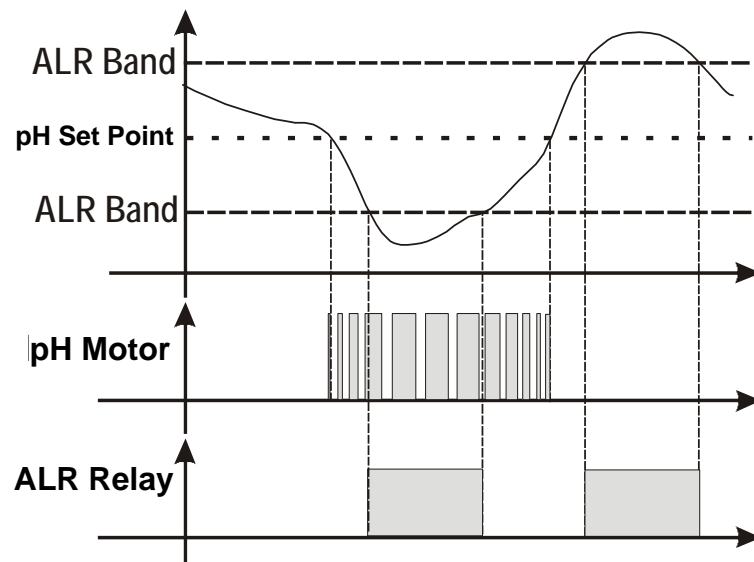

## 10. ACTIVATIONS

### Flow function

By means of the recirculation pump.

High voltage 100 – 240 Vac input, the dosing system is on.

High voltage input is off (the recirculation pump is off), the dosing system displays FLOW flashing.

## 11. ALARMS

**Lev pH**= pH product level probe alarm.

**Lev Rx**= Rx product level probe alarm.

**Lev Flocc**= Flocculant product level probe alarm.

**OFA pH/Rx**= Set Point not reached with the OFA time set\*

**Band pH/RX**= this alarm message is displayed when the detected value is outside of the SetPoint by +/- the set band value.

\*At 70% of the set time the system displays the alarm and activates the alarm relay, at 100% it shuts down the motor. The alarm can be reset by pressing the Enter key.

Pressing the Enter key with the alarm active deactivates the alarm relay, leaving only the alarm message on the display.

## 12. DEFAULT CONTROL PARAMETERS

To reset the default parameters and values, do the following:

- Disconnect the device
- Hold down the + and – keys simultaneously and connect the device
- Confirm the selection to restore the default parameters

Default parameters:

- Configuration = **pH/Rx/Flocc**
- Language = **UK (English)**
- pH Set Point = **7.4 pH; Acid; Off; 3pH PROP**
- Rx Set Point = **750mV; Low; OFF; Alr Band 300mV; PROP**
- Flocculant = **6x10; 1.0cc/ m<sup>3</sup>; 20 m<sup>3</sup>/h**
- Temperature = **25°C**
- Calibration = **FULL**
- Flow Input = **OFF**
- Password = **Disabled**
- Boiler enabled = **YES**
- Recirculation pump enabled = **YES**

### 13. LIST OF POSSIBLE ANOMALIES AND RELATIVE SOLUTIONS

ANOMALY	CAUSE	SOLUTION
The instrument always indicates a pH value of 7.00	Cable and/or connector problem.	1) check for any short circuits on the electrode ↔ instrument connection cable (between the central core of the cable and the external shielding). 2) Make sure there are no traces of humidity and/or condensation on the probe's connector or the device. 3) Make sure that the 100Ω resistance is present between terminals 11 and 12.
The instrument always indicates a high or constantly unstable value	Electrode connection cable damaged.	Check the cable.
	Air bubble in the membrane of the electrode.	Place the electrode in a vertical position and shake it gently until the air bubble rises. <b>N.B.:</b> The electrode must be in a vertical position or at a maximum angle of 45°.
	Electrode consumed.	Replace the electrode.
	Connection cable too long or too close to an electrical cable: disturbances.	Reduce the distance between the device and the probe.
Impossible to calibrate the value of pH 7  Error shown on the display  pH probe calibration quality < 20%	Inadequate buffer solution.	Make sure that the solution being utilised has a pH value of 7.
		Check the pH of the buffer solution with an electronic pH meter.
		Use a new pH 7 buffer solution and repeat the calibration.
pH probe calibration quality < 20%	Problem on the porous material of the probe, dirt residues.	Make sure that the porous material of the probe is in good condition; wash the electrode with a diluted acid-based solution and dry it with a soft cloth.
	Electrode consumed.	Replace the electrode.
Impossible to calibrate the value of pH 4  Error shown on the display  pH probe calibration quality < 20%	Inadequate buffer solution.	Make sure that the solution being utilised has a pH value of 4.
		Check the pH of the buffer solution with an electronic pH meter.
		Use a new pH 4 buffer solution and repeat the calibration.
	Problem in the bulb of the electrode.	Make sure that the bulb of the electrode is not damaged. Make sure that it has not dried outside of the water. As a last resort, clean the electrode and leave it immersed in the water for a few hours.
Electrode consumed.	Replace the electrode.	
Slow electrode response	Electrode electro-statically charged.	During the calibration phase, the electrode MUST NOT be dried with a cloth or paper towel; let it drip dry.

## 14. HANDLING

### Replacing the tube:

①

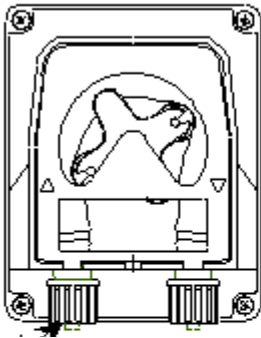

Release the cover by pulling the left hand fitting upward.

②

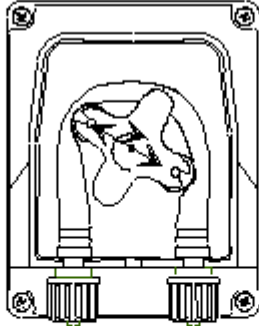

Position the roller at 10 and 20, turning in the direction of the circular arrow.

③

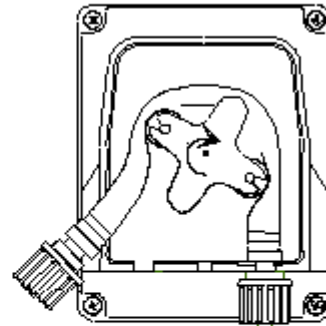

Completely release the fitting on the left, while continuing to press it outwards, and turn the roller in the direction indicated by the circular arrow so as to free the tube up until the right hand fitting.

④



Position the roller at 10 and 20, turning it in the direction of the circular arrow.

⑤

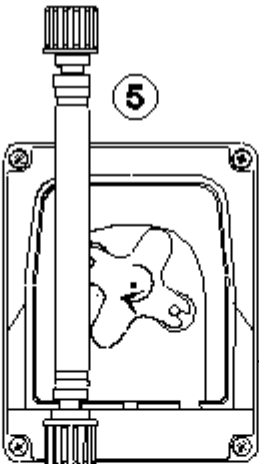

Insert the left hand fitting in the relative lodging and pass the tube beneath the roller's guide. Turn the probe holder in the direction of the circular arrow, while at the same time accompanying the tube into the head of the pump, until reaching the right hand fitting.

⑥

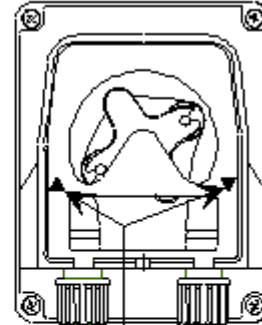

Arrows indicating the direction of the liquid.

Position the pump's cover, respecting the directions of the arrows (▲▼) and press upon the surface with force to close it properly.



## 15. STORING THE PUMP AFTER USE

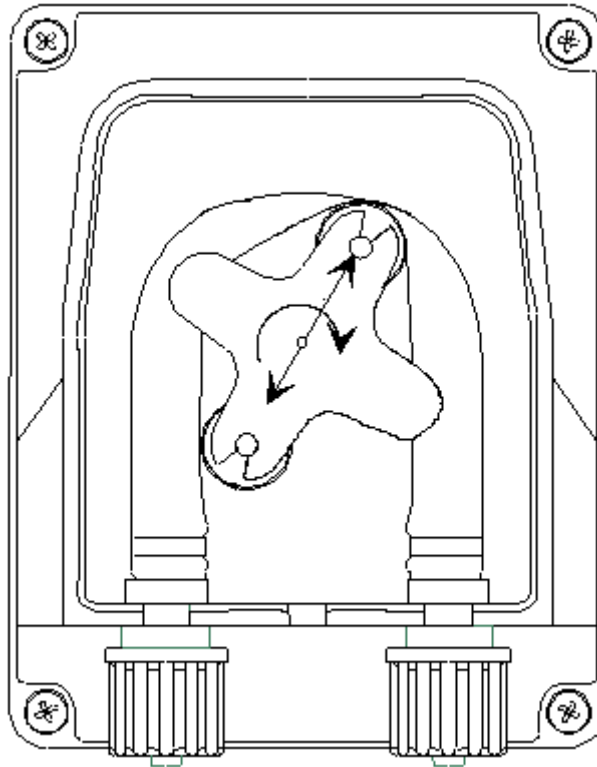

Before storing the regulation device, it is recommended to rinse the tube by pumping clean water.  
Next, position the probe holder at 7 and 05, turning it in the direction indicated by the circular arrow.  
These two precautions will facilitate the device's subsequent reactivation.

# WARNINGS

## PRODUCTS TO BE UTILIZED:

- Reducing the pH value: sulphuric acid based product, easily available on the market.
- Increasing the pH value: alkaline acid based product

## PRODUCTS NOT RECOMMENDED

- Do not use hydrochloric acid.

For all other products, please consult the installer.

## WARNINGS REGARDING THE PROBE

- Handle the probe with CAUTION.
- DO NOT INSERT AN EXCESSIVE AMOUNT of chemical product upstream from the probe.
- Storing the probe: Extract the pH probe from the relative probe holder. Store it in its original container filled with tap water. If necessary, close the probe holder with a cap the size of a 5 cent Euro coin.

As the pH electrode is made up of glass elements, it must be handled with care. All of our electrodes are tested extensively during production before being packaged.

**Electrode repairs under warranty are not foreseen unless they should fail to function upon their first activation. Packaging is excluded.**

In this case, in order for the probe to be accepted for review, it absolutely must be received in its original packaging, along with its relative bottle filled with water.

## BEWARE OF THE FUMES

