

pH or Redox measurement device

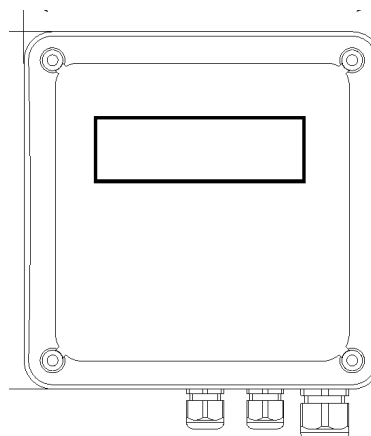
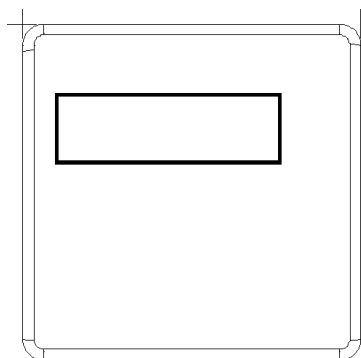
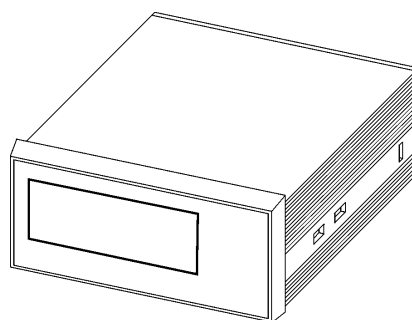
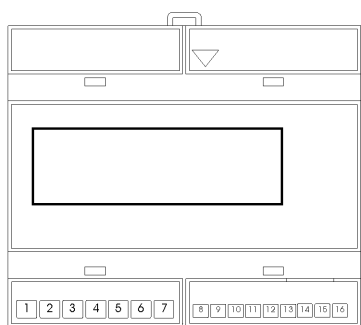

CONTENTS

1	First of all	page 2
2	Installation	page 3
3	Settings and Operation	page 5
4	Troubleshooting	page 11

1 FIRST OF ALL

1.1 WELCOME



Please read this manual carefully, taking particular note of the warnings provided. Always apply the necessary safety procedures, including the use of adequate protection for your face, eyes, and clothing.

1.2 PACK CONTENT

- Measuring instrument
- Fixing brackets
- Instruction manual

1.3 TECHNICAL CHARACTERISTICS

Chemical measurement range: 0÷14.0 pH or ±1500 mV for Redox

Precision: 1% FS pH o 1% FS Redox

Chemical measurement input impedance: 1×10^{13} oHm

Chemical measurement probe connection: BNC

Probe calibration: Software assisted

Temperature measurement range: -10 to +100 °C (Resolution 1 °C)

Automatic temperature compensation from 0 to 100 °C by means of PT 100 sensor or manual setting of the instrument.

Relay output: Set Point 2 (max. resistance load: 10 A 250 VAC)

Current outputs: 1 (max. load 500 ohm) [Precision ±2% F.S.]

Input: 15÷30 VAC/DC

Power Supply: 90÷265 VAC 50/60 Hz

Power rating: 5VA Max

Fuses: 500 mA (delayed)

Display: 2-line 16-character LCD

Keyboard: 4 keys

Dimensions:

- DIN Rail panel-mounted;
- 48 x 96 x 98 mm panel-mounted,
- 96 x 96 panel-mounted,
- 144 x 144 wall-mounted.

Protection level:

- Din-Rail = IP40
- 48x96 = IP40
- 96x96 = IP65 Front panel
- 144x144 = IP65 Full box

1.4 WARNINGS

⚠ Please read this manual carefully before installing and operating the system.

⚠ The dosing unit must be connected to the power supply by means of an omnipolar switch with maximum contact separation of 3mm.

⚠ Check the purchased model for the installation, setting and programming references contained in this manual.

⚠ Refer to the control circuit map provided in this manual when making connections.

⚠ CAUTION: **Always apply the necessary safety procedures, including the use of adequate eyes, face and hands personal protective equipment and the use of proper clothing.**

⚠ CAUTION: **Before installing or servicing this equipment, always disconnect the power supply.**

➡ IT is always working towards perfecting its products and reserves the right to make changes at any time, without prior notice.

➡ Failure to abide by the standards laid down in this manual could result in damage to property or injury to people, as well as damaging the equipment or compromising its operation.

1.5 MATERIALS REQUIRED FOR INSTALLATION

Provide yourself with the necessary material for installing the instrument.

2 Mechanical and Electrical INSTALLATION

2.1. DIN Rail Version (6 EN50022 DIN modules)



2.2 48 x 96 x 100 version



2.3 96 x 96 x 92 version

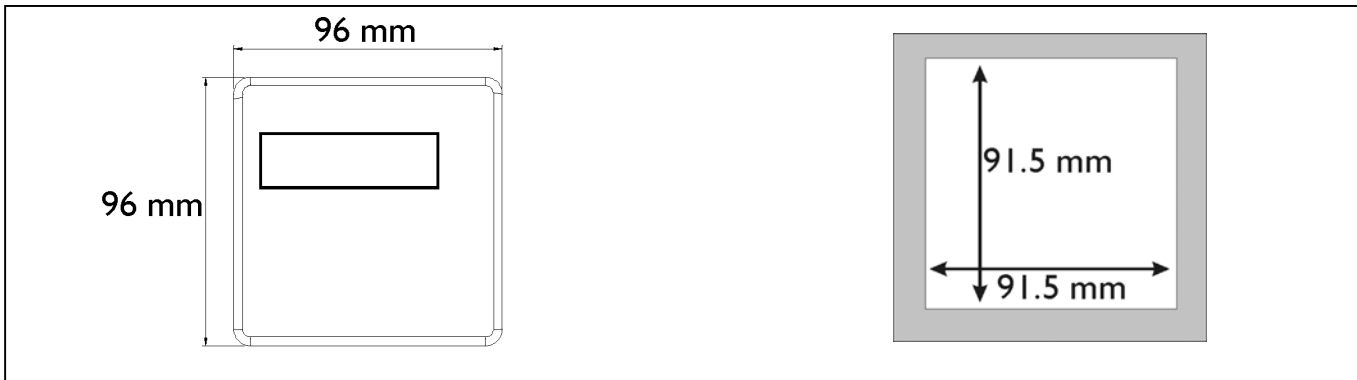

2.4 144 x 144 x 90 version

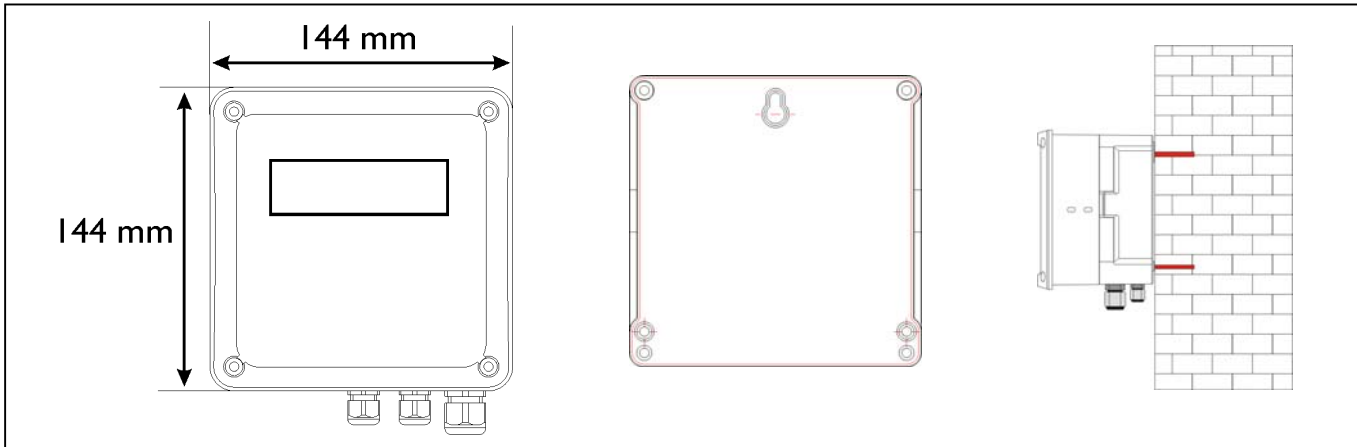

2.5 Description of electrical connections

2.5.1 Electrical connection diagram

Terminal	Description
1	Phase (230 VAC supply)
2	Earth
3	Neutral (230 VAC supply)
4-5	Set Point 1 Relay
6-7	Set Point 2 Relay
8-9	0/4÷20 mA current output
10	Not used
11-12	VDC input VDC 15÷30 Vdc Hold
13-14	Temperature probe input
15-16	Not used
BNC	pH/Redox probe input

2.5.2 Electrical connection label for each model

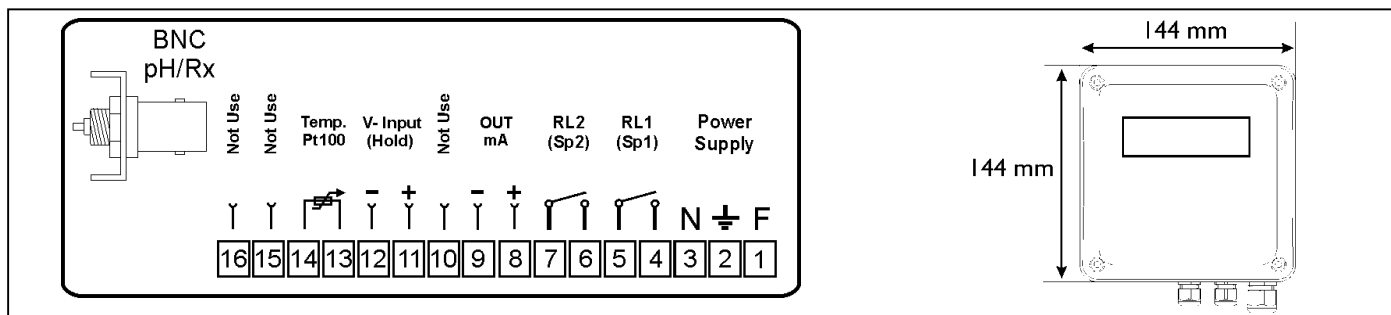
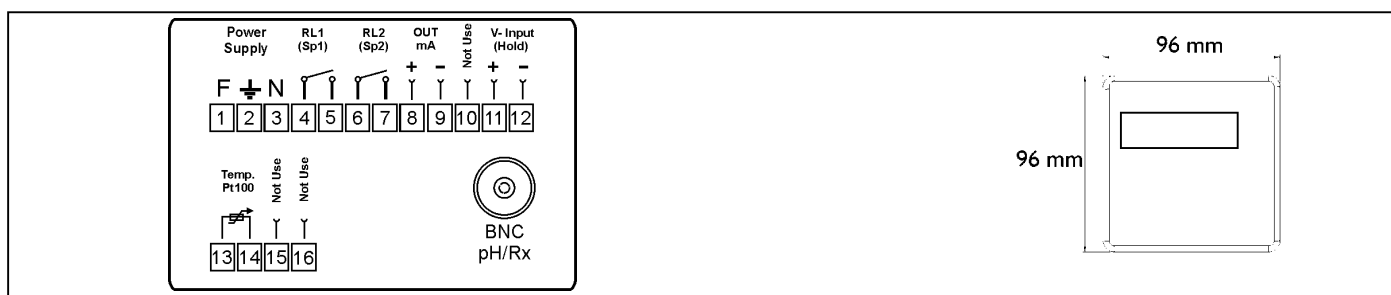
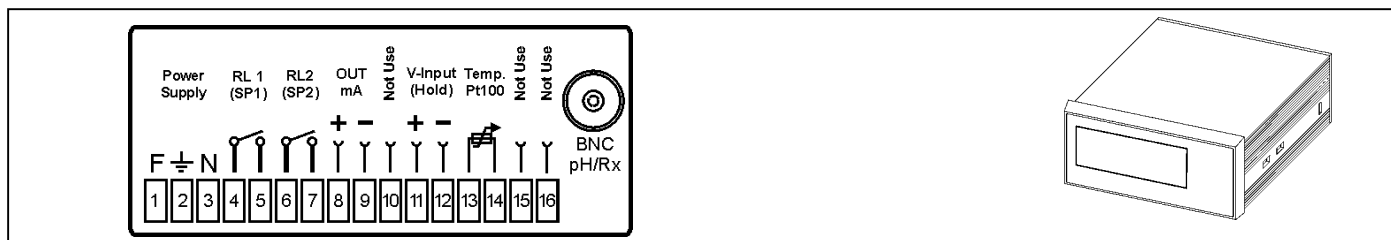
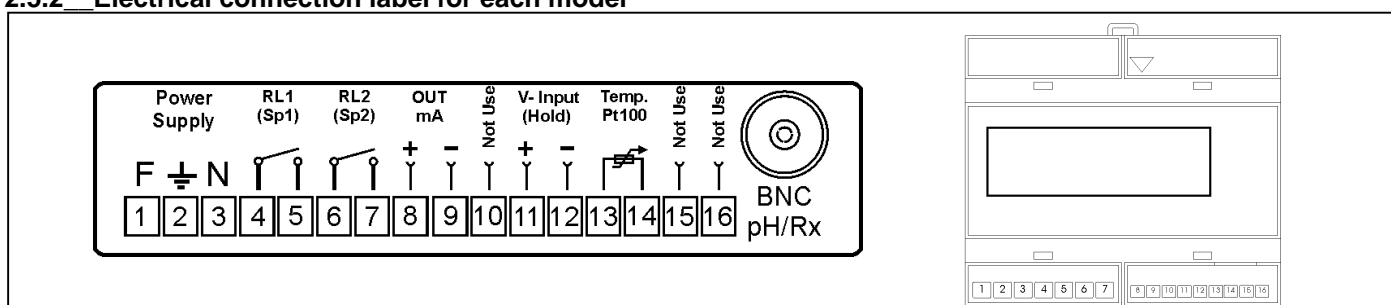

2.6 PLUMBING CONNECTIONS

None

3.0__ SETTINGS AND OPERATION

3.1__ Instrument Display

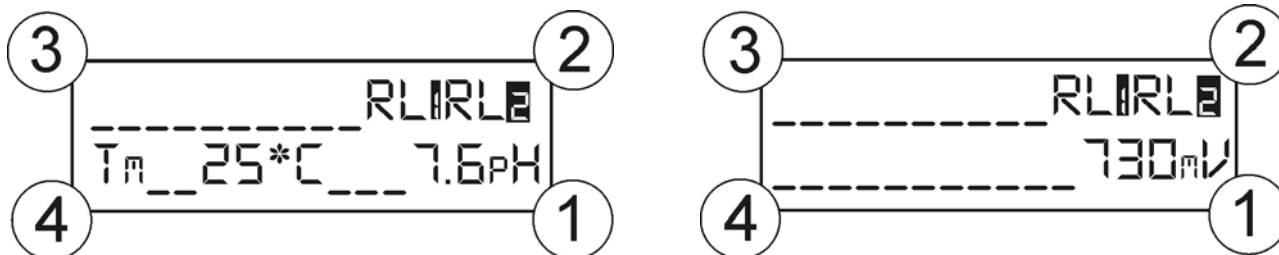

Area 1 = pH or Redox chemical measurement display

Area 2 = Relay 1 and 2 status display. If the relay's number is blinking, the contact has changed status.

Area 3 = Alarms display

Area 4 = Manual or automatic temperature display for pH measurement; this area is empty for Redox version.

Note: The RL2 icon becomes RLA when Set Point 2 is set as an Alarm.

3.2__ Instrument keyboard

Esc/Mode = Double-function key: **Esc** = Immediate exit from menu, **Mode** = quick settings menu

Enter/ Cal = Double-function key: **Enter** = Confirm function, **Cal** = Immediate calibration access

Up = Increase key

Down = Decrease key

Probe calibration function (Press the **Cal** key for 3 seconds [press Esc to exit])

- Calibrating the pH probe
 - Immerse the probe in the 7 pH solution and press Enter.
 - Wait 60 seconds for self-calibration. When finished, probe accuracy is shown as a percentage.
 - Immerse the probe in the 4 pH or 9.22 pH solution and press Enter.
 - Wait 60 seconds for self-calibration. When finished, probe accuracy is shown as a percentage.
- Calibrating the Redox probe
 - Immerse the probe in the 465 mV solution and press Enter.
 - Wait 60 seconds for self-calibration. When finished, probe accuracy is shown as a percentage.

Mode Function (quick programming menu) (Press the **Mode** key for 1 second. Select using the up and down keys)

- Set Point 1 7.4 pH (Press the Enter key and adjust the value using the up and down keys)
- Set Point 2 7.4 pH (Press the Enter key and adjust the value using the up and down keys)
- Relay 1 (Press the Enter key to change the relay's status)
- Relay 2 (Press the Enter key to change the relay's status)

Note: The instrument exits automatically after 10 seconds.

Value settings menu function (Press the **Enter** and **Esc** keys for 5 seconds)

- Language (Set menu's language)
 - Available in English (UK), French (FR), Spanish (ES), German (DE), Italian (IT)
- Set Point 1 (Set dosing or control functions via relay 1)
- Set Point 2 (Set dosing or control functions via relay 2)
- Temperature (Menu available only for pH measurement)
- mA output (Set current output)
- Advanced (technical management menu)

Default parameters reset function

- Switch off the instrument.
- Press the **Up** and **Down** keys together and turn on the instrument.
- The instrument displays "init._Default". Select **Yes** using the Up or Down keys and press Enter.
- The instrument reloads all of the default parameters.

Note: To exit the menus, press **Esc**.

3.3 GENERAL SETTINGS

Press the **Enter** and **Esc** keys at the same time. Value Programming:

Programming Menu (Default parameters)		
Language		
Language setting	UK	
Set Point 1		
Set Point value	7.4 pH	
Type of dosing	Acid	
Proportional band	0.4 pH	
Hysteresis	0.0 pH	
ON Timer	OFF	
OFF Timer	OFF	
Delay Start	OFF	
Delay End	OFF	
Set Point 2 (Set Point 1 Dosing or Alarm can be selected, see advanced menu)		
Set Point value	7.4 pH	
Type of dosing	Acid	
Proportional band	0.4 pH	
Hysteresis	0.0 pH	
ON Timer	OFF	
OFF Timer	OFF	
Delay Start	OFF	
Delay End	OFF	
Temperature (*)		
Measurement unit	°C	
Manual Value	25 °C	
mA Output		
Range 0/4÷20 mA	4÷20 mA	
Value for 0 / 4 mA	Value 0 pH	
Value for 20 mA	Value 14 pH	
Advanced		
Select pH/Redox	pH	
Resolution	Low	
Dosing or Alarm Set Point 2	Dosing	
Hold input enabled or disabled	Disabled = ON	
Calibration enabled or disabled	Enabled = ON	
Statistics		
	Number of measurement alarms	0
	Number of RL1 activations	0
	Number of RL2 activations	0
	Number of Hold input signals	0
	Statistics reset	
Control Panel		
	Relay 1 contact normally open or closed	Normally open
	Relay 2 contact normally open or closed	Normally open
	Manual current output	0÷20 mA current generator
	mV input probe signal	Displays signal in mV
	Hold signal present	Signal present, ON; missing, OFF
	Temperature probe calibration (**)	Set offset value
	Offset calibration	Offset in %, last calibration
	Gain calibration (*)	Gain in %, last calibration
	Firmware version	X.X
Instrument reset	Restore default values	
Password	0000	

*menu present only with pH measurement

** menu present only with temperature probe installed

3.3__Programming menu detailed settings

Press the Enter and Esc keys together for 5 seconds to access the instrument's programming menu.

Language menu: Set the desired language from the following:

- Italian
- English
- French
- Spanish
- German

Set Point 1 menu: Set the dosing parameters; all settings will be activated by Relay 1.

The menu contains the following items:

Item	Default	Limits
Set Point value	7.4 pH / 750 mV	0÷14 pH / ±1500 mV
Type of dosing	Acid / Low	Acid or Alkaline/High or Low
Proportional band	0.4 pH / 40 mV	0.4÷3 pH / 40÷300 mV
Hysteresis	0.0 pH / 0 mV	0÷3 pH / 0÷300 mV
ON Timer	OFF	OFF...1÷480 minutes
OFF Timer	OFF	OFF...1÷480 minutes
Delay Start	OFF	OFF...3÷960 seconds
Delay End	OFF	OFF...3÷960 seconds

Set Point 2 menu: Set the dosing parameters; all settings will be activated by Relay 2.

The menu contains the same items as Set Point 1 if **SET POINT 2 = Dosing** (see Advanced menu, page 8).

If **SET POINT 2 = ALARM** (see Advanced menu, page 8), Relay 2 can be used as a measurement alarm for Set Point 1. The menu therefore changes as follows:

Item	Default	Limits
Set Point 1 alarm band	3 pH / 300 mV	0.1÷10 pH; 100÷1000 mV
OFA (Set Point 1 over feed alarm)	OFF	OFF÷960 minutes

Temperature menu: Set the temperature for automatic compensation of the pH measurement. The measurement unit may also be set.

Item	Default	Limits
Measurement unit	°C	°C; °F
Manual Value	25 °C	0÷100 °C; 32÷212 °F

Current output: Set the current output scale and values.

Item	Default	Limits
Scale: 0/4÷20 mA	4÷20 mA	0÷20 mA; 4÷20 mA
Value: 0/4 mA (*)	0 pH / -1500 mV	0÷14 pH / ±1500 mV
Value: 20 mA (*)	14 pH / 1500 mV	0÷14 pH / ±1500 mV

(* For ramp inversion, the scale's opposite value can be set: 20 ÷ 4/0 mV)

Advanced menu: The following items can be used to modify the instrument's functions and to control each function. This menu is for specialized technical personnel only.

Item	Default	Limits
Select pH/Redox	pH	pH; Redox
Resolution	Low	High or Low
Dosing or Alarm Set Point 2	Dosing	SP1 Dosing or Alarm
Hold input enabled or disabled	ON	OFF= Disabled; ON= Enabled
Calibration enabled or disabled	ON	OFF= Disabled; ON= Enabled

The instrument's number of activations or variations can be verified using the *Statistics* menu.

Statistics		
Number of measurement alarms		0
Number of RL1 activations		0
Number of RL2 activations		0
Number of Hold input signals		0
Statistics reset		

To facilitate the installer during system testing, each input and output on the instrument panel can be manually set and verified using the following *Control Panel* menu.

Control Panel		
Relay 1 contact normally open or closed		Normally open
Relay 2 contact normally open or closed		Normally open
Manual current output		0÷20 mA current generator
mV input probe signal		Displays the probe signal in mV
Hold signal present		Signal present ON; missing OFF
Temperature probe calibration (**)		Set offset value
Calibration offset Value		Offset in %, last calibration
Gain calibration (*)		Gain in %, last calibration
Firmware version		X.X

*menu present only with pH measurement

** menu present only with temperature probe installed

Note: The instrument does not automatically exit from the *Control Panel* menu so that the installer may work manually. Press the ESC key to exit.

All of the default parameters can be reset with the *Instrument Reset* menu. It automatically exits the Settings menu. The default parameters are shown on page 6.

Instrument Reset	Restore default values
------------------	------------------------

The Settings menu can be protected from unauthorized personnel by means of the *Password* menu. The standard password is 0000. If the programmed password is lost or forgotten, access the hidden menu shown on page 5 to reset the factory defaults.

Password	0000
----------	------

3.4__Dosing and adjustment examples

Dosing Operation/Pause (ON-OFF)

The instrument permits automatic control and modification of the chemical measurement through Set Point 1, adjusting dosing by means of On-Off Relay 1.

The dosing example on the side can be set using the following parameters:

- Set Point 1 = 7.20 pH
- Type of Dosing = Alkaline
- Proportional Band = OFF
- Hysteresis = 0.40
- ON Timer = OFF
- OFF Timer = OFF

The instrument will begin dosing for values below 7.20 and will stop dosing when above 7.60. If Acid is set for Type of Dosing, dosing will be the exact opposite: dosing will begin above 7.20 and will stop below 6.80 pH. The instrument permits two independent dosings by setting Set Point 2 associated with Relay 2.

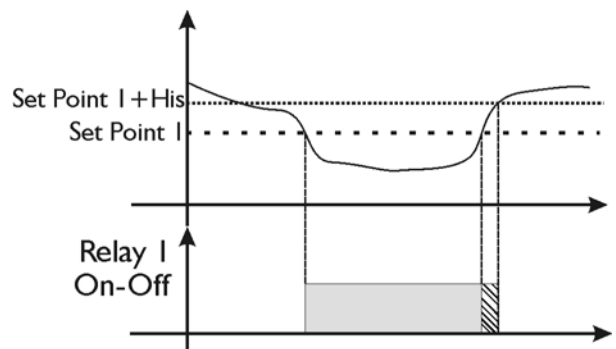

Timed Dosing

The instrument permits automatic control and modification of the chemical measurement through Set Point 1, adjusting dosing by means of Timed Relay 1.

The dosing example on the side can be set using the following parameters:

- Set Point 1 = 7.20 pH
- Type of Dosing = Alkaline
- Proportional Band = OFF
- Hysteresis = 0.40
- ON Timer = 5 minutes
- OFF Timer = 10 minutes

The instrument will begin timed dosing for values below 7.20 and will stop dosing when above 7.60. If Acid is set for Type of Dosing, dosing will be the exact opposite: dosing will begin above 7.20 and will stop below 6.80 pH. The instrument permits two independent dosings by setting Set Point 2 associated with Relay 2.

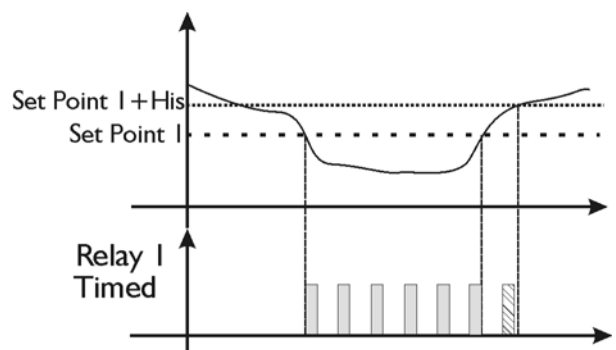

Proportional Dosing (Prop)

The instrument permits automatic control and modification of the chemical measurement through Set Point 1, adjusting dosing by means of Proportional Relay 1.

The dosing example on the side can be set using the following parameters:

- Set Point 1 = 7.20 pH
- Type of Dosing = Alkaline
- Proportional Band = 0.40 pH
- Hysteresis = 0.40
- ON Timer = 10 minutes (*)
- OFF Timer = 10 minutes (*)

The instrument will begin proportional dosing for values below 7.20 and will stop dosing when above 7.60. If Acid is set for Type of Dosing, dosing will be the exact opposite: dosing will begin above 7.20 and will stop below 6.80 pH. The instrument permits two independent dosings by setting Set Point 2 associated with Relay 2.

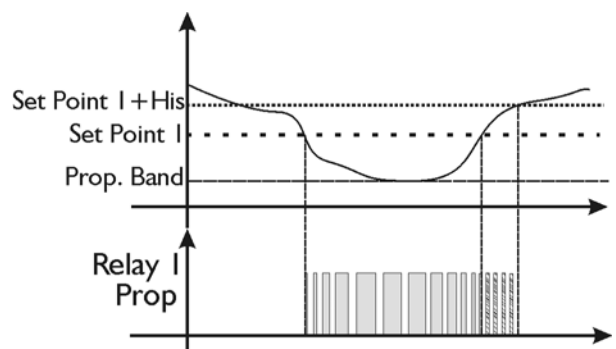

(* when equal times are set for ON Timer and OFF Timer, the instrument calculates a total period that it automatically modifies in relation to the chemical measurement's variation. In the hysteresis band, it doses at the minimum value)

Note: All of the adjustment and dosing settings also apply to Redox measurement.

Relay 2 used as alarm for Set Point 1

When the Alarm Band is set, an operation window is created. When these limits are surpassed, Relay 2 closes and remains closed until the measurement is reset or the Enter key is pressed to deactivate the alarm.

When the OFA time (Over Feed Alarm) is set, the dosing time of Set Point 1 is controlled with two alarms:

- First alarm: 70% of the programmed time is shown on the display and Relay 2 closes.
- Second alarm: 100% of the programmed time is shown on the display and Relay 2 closes.

Eliminate the alarm by pressing the Enter key.

Note: The RL2 icon is transformed into RLA.

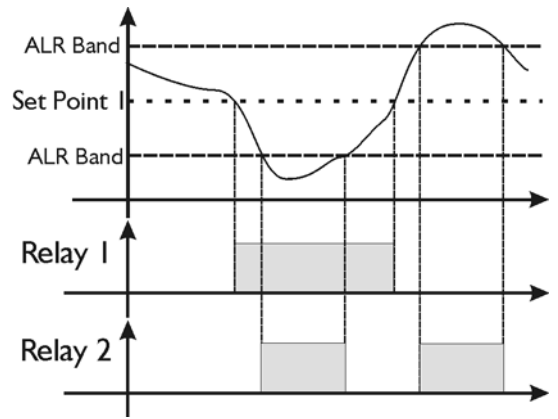

Dosing with delays

The instrument permits dosing start and end delays. The dosing example on the side can be set using the following parameters:

- Delay Start (D-1) = 5 minutes
- Delay End (D-2) = 5 minutes

This function is available for all of the previously described settings: ON-OFF, Timed, Prop.

Note: The variables shown above are independently available for Set Point 1 and Set Point 2.

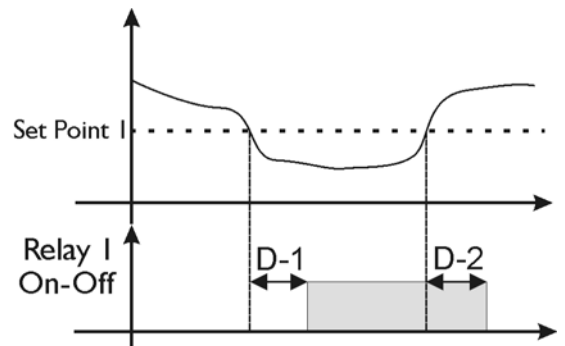

4 TROUBLESHOOTING

- **The device does not come on...**
 - Make sure that the power cables are correctly connected
 - Check whether the power supply is present
- **The display does not light up...**
 - Regulate the display contrast
- **The chemical measurement function does not work...**
 - Check the probe connection
 - Calibrate as instructed in the manual
 - Replace the probe
- **The mA output does not change...**
 - Check the cable connection
 - Use the "Manual Control" function in the main menu to check whether the output produces the desired effect.
 - Check the electrical characteristics of the remote device (maximum load: 500 ohm).
- **The relays do not work...**
 - Check whether the instrument is correctly powered
 - Check the settings in the main menu
- **The VDC port voltage does not stop the instrument...**
 - Check the electrical connections
 - Check whether the remote generator is working.

Note: If the anomaly persists, please contact the supplier.

4.1 Alarm table:

Alarm	Display	Relay status	Solutions	Priority
Hold	Hold ALR	RL1 and RL2 disabled	Eliminate signal on Hold voltage input	1
OFA pre-alarm Time > 70%	OFA ALR	RL2 Closed	- Press Enter to eliminate the alarm. - Check the system.	2
OFA Alarm Time = 100%	OFA Stop	RL2 Closed	- Press Enter to eliminate the alarm. - Check the system.	3
Measurement alarm band	Band ALR	RL2 Closed	- Press Enter to silence Relay 2. - Check the system.	4

ADDENDUM



FR -Mise au rebut du produit / Protection de l'environnement :

Conformément aux exigences de la directive DEEE - 2002/96/CE (Déchets d'Équipements Électriques et Électroniques), les produits électriques et électroniques usagés doivent être détruits séparément des ordures ménagères normales afin de promouvoir la réutilisation, le recyclage et d'autres formes de récupération, ainsi que de limiter la quantité de déchets devant être éliminés et de réduire du même coup les décharges. **Lorsque vous vous débarrasserez de ce produit, respectez les prescriptions locales pour l'élimination des déchets. Ne le jetez pas dans la nature, mais remettez-le à un centre de collecte spécialisé de rebuts électriques et électroniques et/ou renseignez-vous auprès de votre revendeur lors de l'achat d'un nouveau produit.**

UK - Product waste disposal / Protection of the environment:

In accordance with the provisions of the Waste Electrical and Electronic Equipment (WEEE - 2002/96/EC) Directive, used electric and electronic products must be destroyed separately from normal household waste in order both to promote re-use, recycling and other forms of recovery and to reduce the quantity of waste to be destroyed and hence the disposal operations. **When you dispose of this product, comply with the local waste disposal instructions. Do not throw it away in the middle of nowhere: take it to a waste collection centre that specialises in used electrical and electronic products and/or consult your dealer when buying a new product.** **ES - Eliminación del producto / Protección del medio ambiente:**

ES - Eliminación del producto / Protección del medio ambiente:

De conformidad con las exigencias de la directiva RAEE - 2002/96/CE (Residuos de Aparatos Eléctricos y Electrónicos), los productos eléctricos y electrónicos usados deberán destruirse aparte de las basuras domésticas normales con el fin de facilitar la reutilización, el reciclaje y otras formas de recuperación, así como de limitar la cantidad de residuos que deben ser eliminados y reducir al mismo tiempo los vertederos. **Cuando se desprenda de este producto, respete las normas locales de eliminación de residuos. No lo arroje al medio ambiente, entréguelo en un centro de recogida especializado en residuos eléctricos y electrónicos o infórmese a través del vendedor cuando adquiera un nuevo producto.** **DE -Entsorgung Des Produktes - Umweltschutz:**

DE -Entsorgung Des Produktes - Umweltschutz:

In Übereinstimmung mit der EEAG-Richtlinie - 2002/96/EG (Entsorgung von Elektro- und Elektronikabfällen) müssen Elektro- und Elektronik-Altgeräte vom normalen Hausmüll getrennt entsorgt werden, um die Wiederverwendung, das Recycling und andere Arten der Wiedergewinnung zu fördern sowie die zu vernichtende Abfallmenge zu beschränken und somit gleichzeitig die Mülldeponien zu reduzieren. **Beachten Sie bitte die lokalen Vorschriften für die Entsorgung von Abfällen, wenn Sie sich von diesem Gerät trennen möchten. Werfen Sie es nicht in die Natur, sondern geben Sie es bei einer speziellen Sammelstelle für Elektro- und Elektronikabfälle ab und/oder informieren Sie sich bei Ihrem Händler beim Kauf eines neuen Produktes** **IT - Scarto in disparte del prodotto / Protezione dell'ambiente:**

IT - Scarto in disparte del prodotto / Protezione dell'ambiente:

In conformità con le esigenze della direttiva RAEE – 2002/96/CE (Rifiuti di Apparecchiature Elettriche ed Elettroniche), i prodotti elettrici ed elettronici usati devono essere distrutti separatamente dai normali rifiuti domestici allo scopo di favorire il riutilizzo, il riciclaggio e le altre forme di recupero, oltre a limitare la quantità di rifiuti che devono essere eliminati ed a ridurre allo stesso tempo le discariche. **Quando dovete sbarazzarvi di questo prodotto, rispettate le norme locali per l'eliminazione dei rifiuti. Non gettatelo in mezzo alla natura, ma consegnatelo ad un centro di raccolta specializzato in scarti elettrici ed elettronici e/o informatevi presso il vostro rivenditore al momento dell'acquisto di un nuovo prodotto.** **NL -Wegwerpen van het product / Bescherming van het milieu:**

NL -Wegwerpen van het product / Bescherming van het milieu:

In overeenstemming met de vereisten van de AEEA – richtlijn - 2002/96/EG (afgedankte elektrische en elektronische apparatuur), dienen versleten en gebruikte elektrische en elektronische producten apart van het normale huisvuil vernietigd te worden ter bevordering van hergebruik, recycling en andere vormen van herverwerking om zo tegelijkertijd de hoeveelheid te verwerken afvalstoffen alsmede de omvang van de vuilstortplaatsen terug te dringen. **Neem, indien u dit product weg wilt werpen, de voorschriften voor afvalverwerking in acht. Werp het product niet in de natuur weg maar breng het naar een specifiek verzamelpunt voor elektrisch en elektronisch afval en /of vraag uw dealer om inlichtingen tijdens de aanschaf van een nieuw product.** **PT - Eliminação do produto / Protecção do ambiente :**

PT - Eliminação do produto / Protecção do ambiente :

Nos termos do disposto na Directiva relativa aos resíduos de equipamentos eléctricos e electrónicos – 2002/96/CE (REEE), e com vista à promoção da reutilização, da reciclagem e de outras formas de recuperação, por um lado, e a limitar a quantidade de resíduos a serem eliminados e, simultaneamente, a reduzir as descargas, pelo outro, os produtos eléctricos e electrónicos usados devem ser eliminados separadamente em relação ao lixo doméstico. **Quando este seu produto chegar ao fim da sua vida útil, cumpra o disposto na legislação local relativamente à eliminação de resíduos. Nunca junte este produto ao lixo doméstico; em vez disso, entregue-o num centro de recolha especializado na eliminação de produtos eléctricos ou electrónicos e/ou informe-se das medidas a tomar junto do seu revendedor aquando da aquisição de um produto novo**