

25

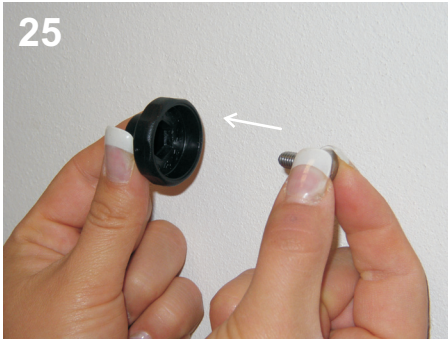

26

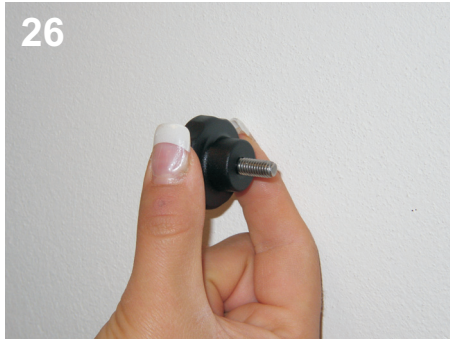

27

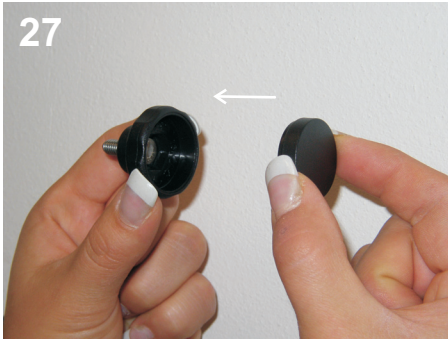

28

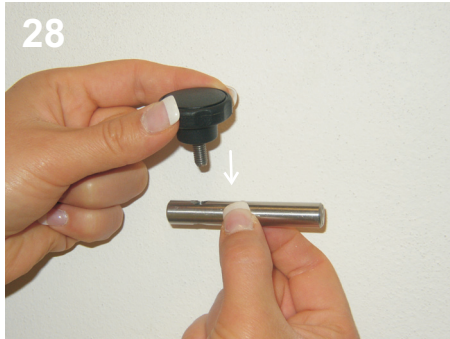

29

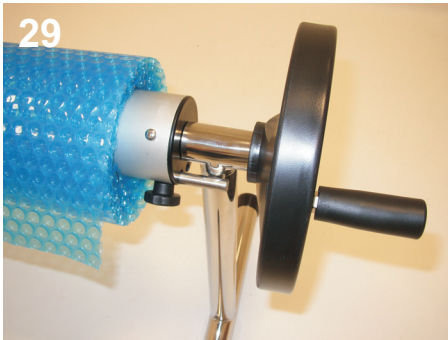

30



VÄGNER

SWIMMING POOL TECHNOLOGY AND ACCESSORIES



NÁVOD NA MONTÁŽ POJÍZDNÉHO NAVÍJECÍHO ZAŘÍZENÍ

*INSTRUCTIONS FOR ASSEMBLY
OF MOBILE REEL SYSTEM*

2,7 - 3,6m

3,7 - 4,6m



Obsah balení / Content of package

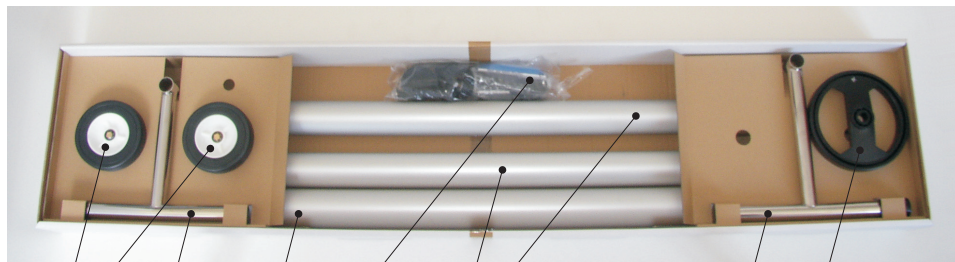

2x 1x 1x 2x 1x 1x

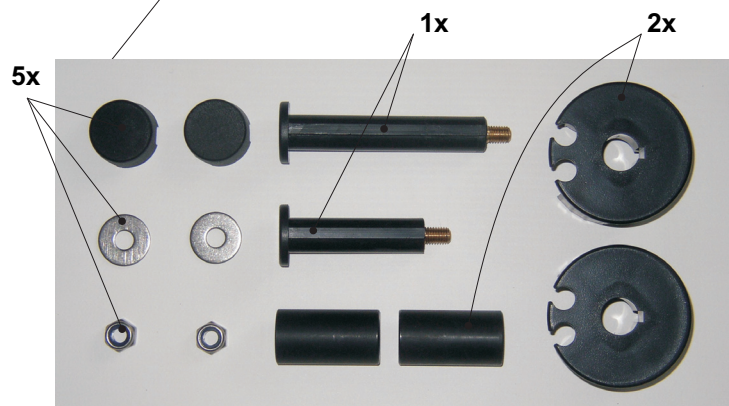

5x 1x 2x

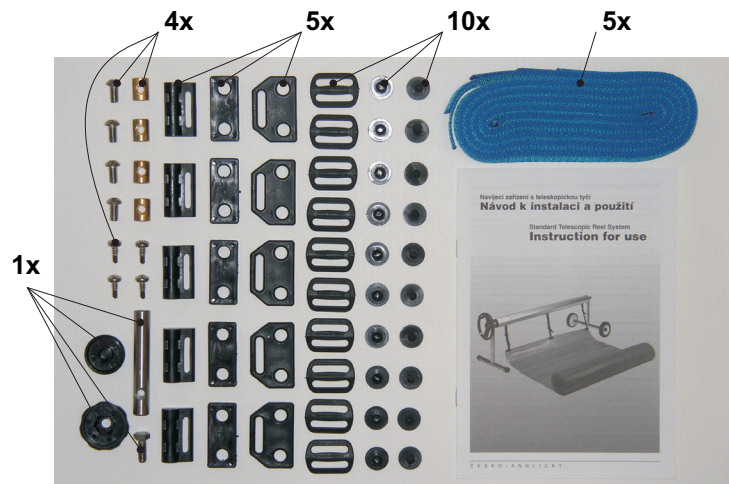

4x 5x 10x 5x 1x

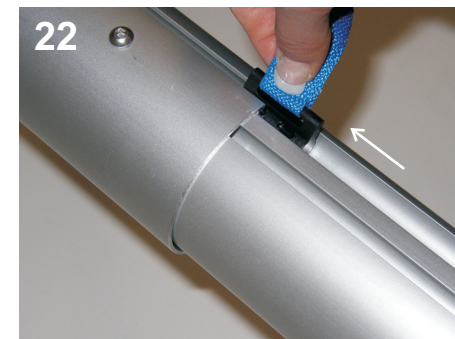
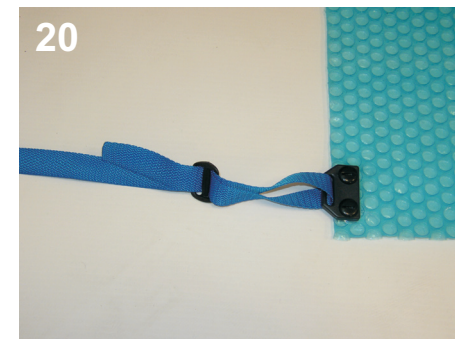
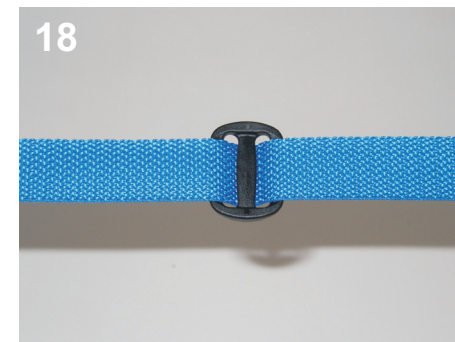
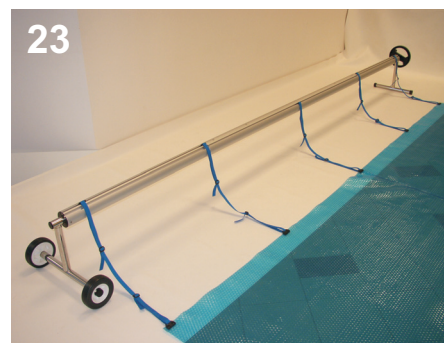
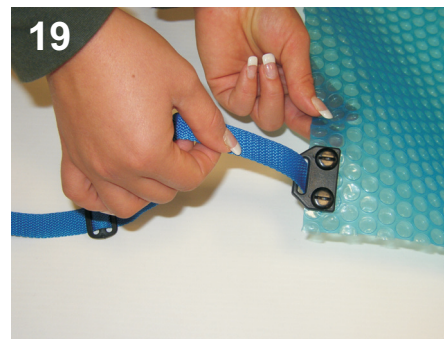
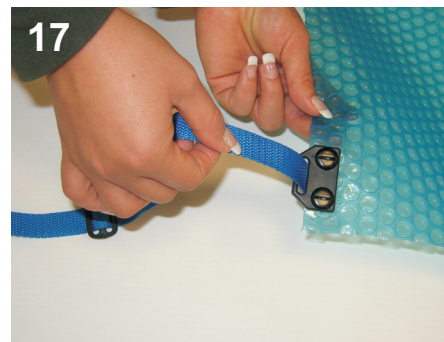

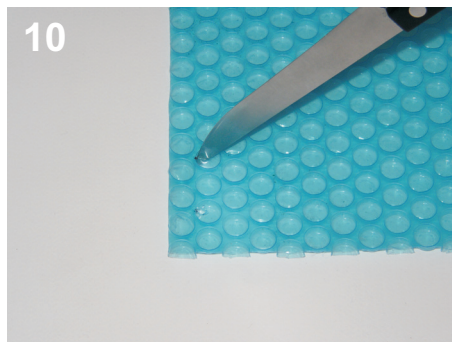
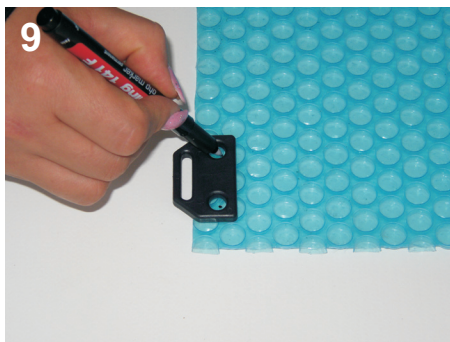

Nástroje potřebné pro správnou montáž Tools required for correct assembly

Gumová palička
Rubber hammer



Nástrčkový klíč (imbus) 4mm
Socket wrench 4mm



Klíč s vnitřním šestihranem 17mm
Key with inne hexagram 17mm



Šroubovák křížový PH3
Screddriwer cruciate



Levá ruka
Left hand



Pravá ruka
Right hand

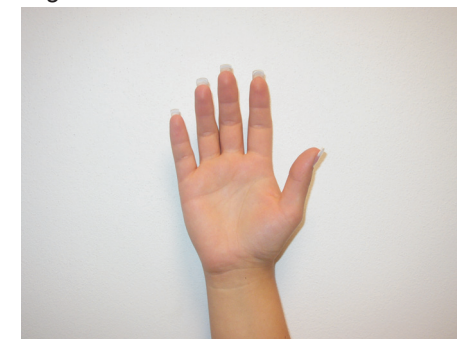

Postup montáže pojízdného navíjecího zařízení Assembly technique of mobile reel system

1. Stojna s kolečky / Stand with wheels

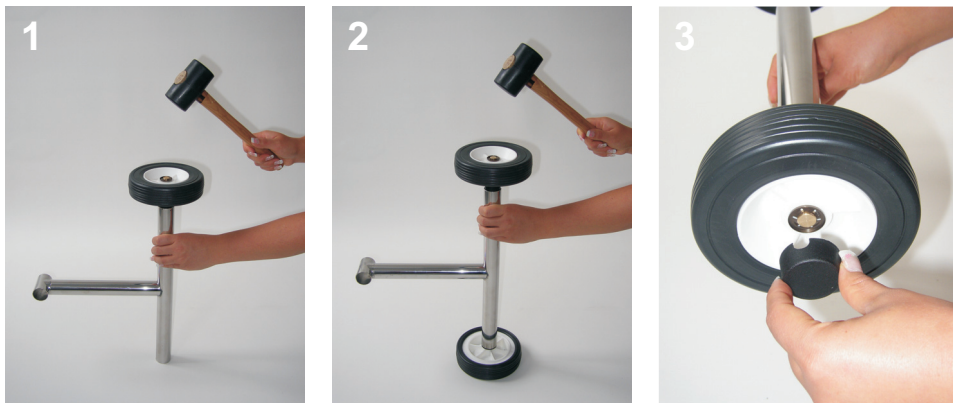

5. Uchycení solární plachty / Fixing for solar cover

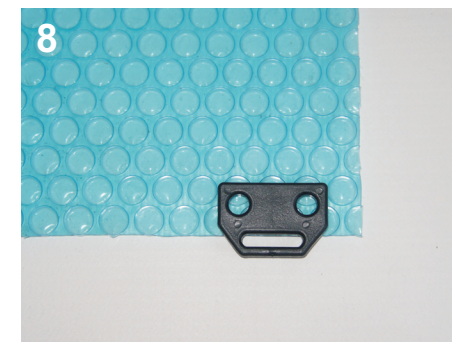
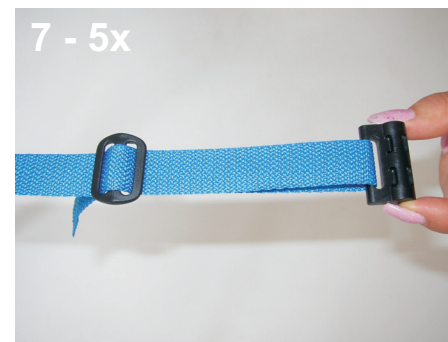
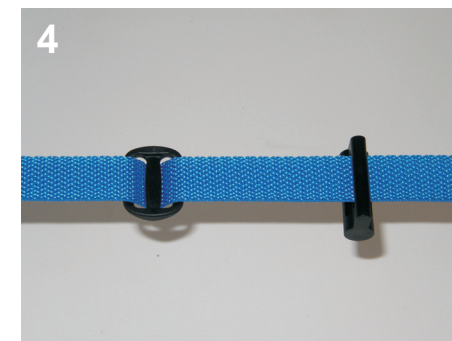
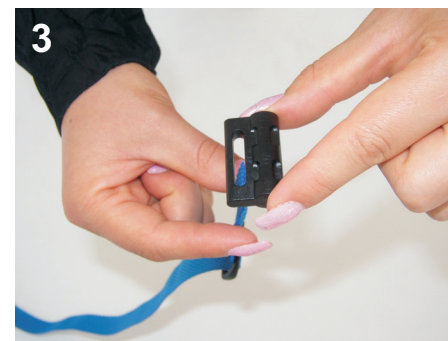
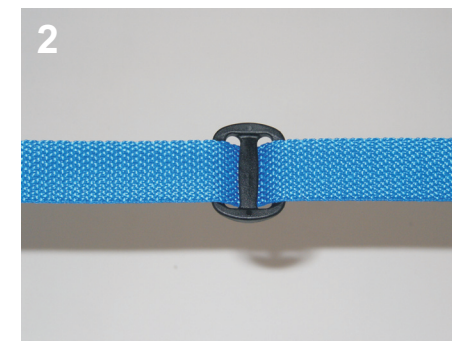

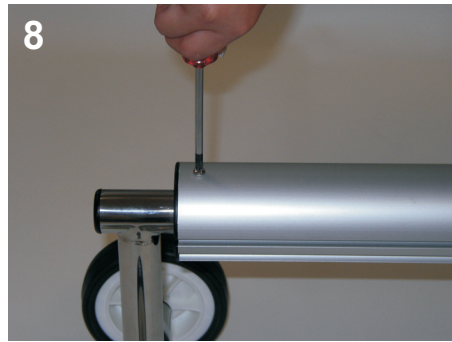
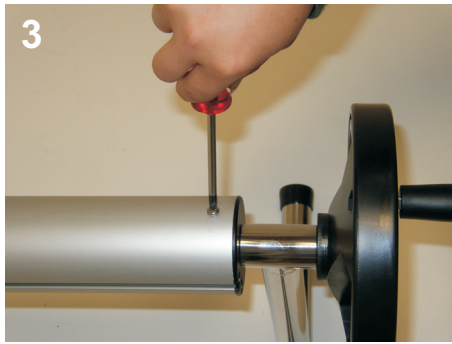

2. Stožna s volantom / Stand with steering wheel





3. Teleskopická tyč / Telescopic tube

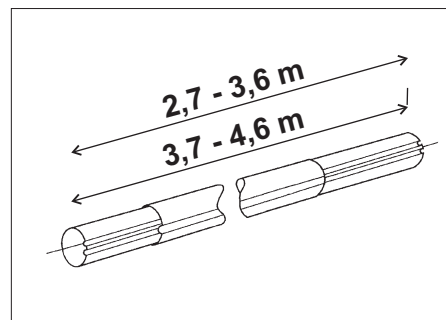
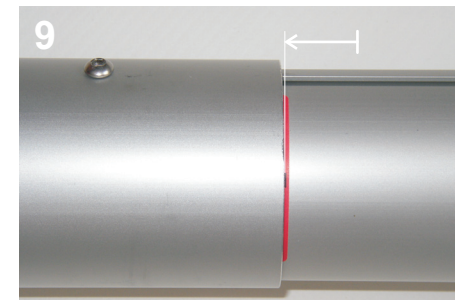
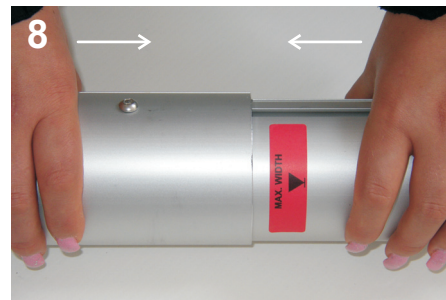
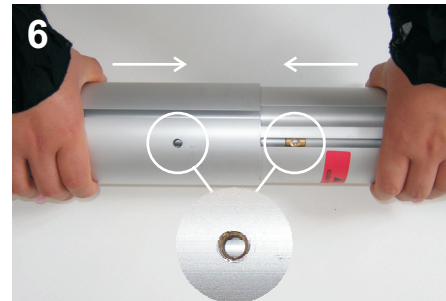
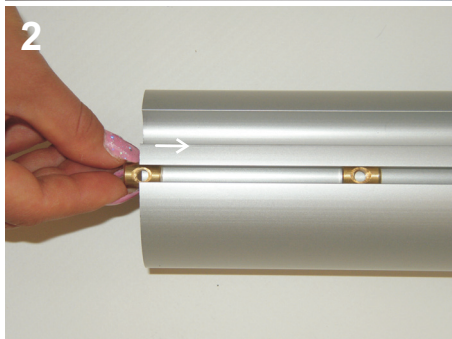
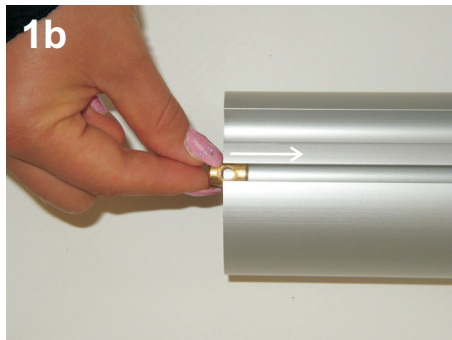
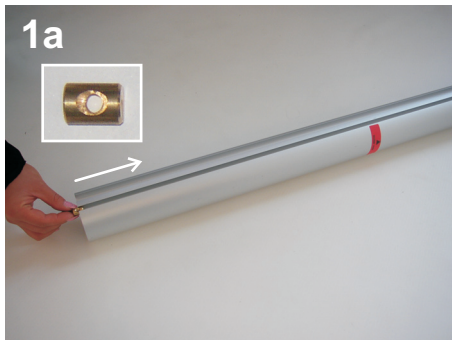

4. Složení navíjecího zařízení / Reel system assembly

