

Contents

1 / LIST OF PARTS	15
ADVICE	15
2 / FITTING THE HOSE	16
3 / CONNECTING	17
4 / FLOW TEST	19
5 / HOSE AND CLEANER ASSEMBLY	20
6 / TROUBLESHOOTING	21
7 / CLEANING, REPLACING THE DIAPHRAGM	22
8 / WARRANTY	24

Dear customer,

Congratulations on your purchase of the ZODIAC T5 Duo Suction cleaner. We would like to thank you for your custom.

Your appliance has been designed, manufactured and checked with the greatest care to ensure you are completely satisfied with the product.

Before using the appliance read this manual carefully. It contains all the information needed in order to get the most from your pool cleaner in complete safety.

For any further information your retailer, a pool professional, will be able to advise you on how to use and maintain your pool cleaner.

They will be able to supply spare parts and will provide qualified After Sales service.

1 / List of parts

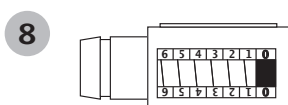
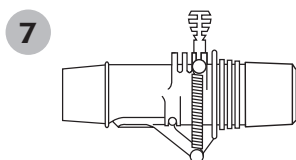
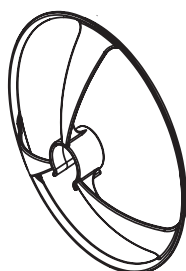
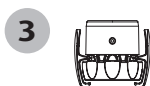
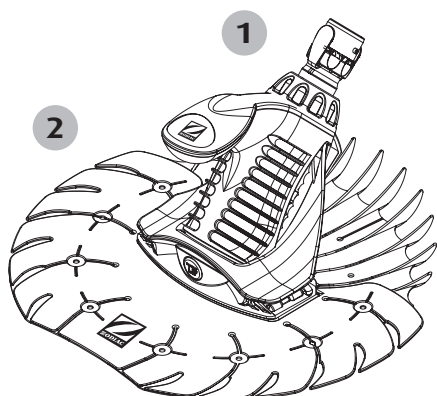

Below is the list of parts shipped in the box needed to install your T5 Duo:

- 1 Complete head
- 2 Complete disk
- 3 Quick connector
- 4 Deflector wheel (used if the cleaner jams on obstacles, ladders, steps,...)
- 5 Set of 12 Twist Lock 1 metre hose sections
- 6 1 hose counter-weight
- 7 1 automatic flow regulation valve
- 8 1 flow tester
- 9 1 cone adapter

REF.	NAME	QUANTITY
1	Complete Head	1
2	Complete disk	1
3	Quick connector	1
4	Deflector wheel	1
5	Set of 12 Twist Lock 1 metre hose sections	12
6	Hose counter-weight	1
7	Automatic flow regulation valve	1
8	Flow tester	1
9	Cone adapter	1

ADVICE

During the season we recommend you leave your T5 Duo in the pool and remove it when you do shock treatments.

If you wish to remove it while bathing, remove the hose, but do not roll it up.

Never expose the hose to direct sunlight.

When the season is over, we recommend that you rinse the hose sections in clear water and you store them in a dry place.

2 / Fitting the hose

The hose for your T5 Duo is composed of 12 x 1 m sections.

- The ideal hose length for your pool corresponds to one 1 m hose section plus the greatest distance between the Connection point (suction point or skimmer) and the furthest point in your pool (**Figure 1**).

Ex: if the greatest distance between the suction point or skimmer and the furthest point equals 10 metres, you will need 11 sections of 1 metre.

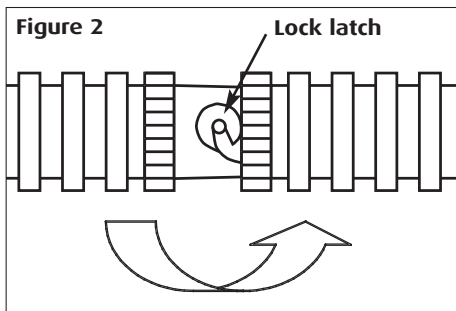
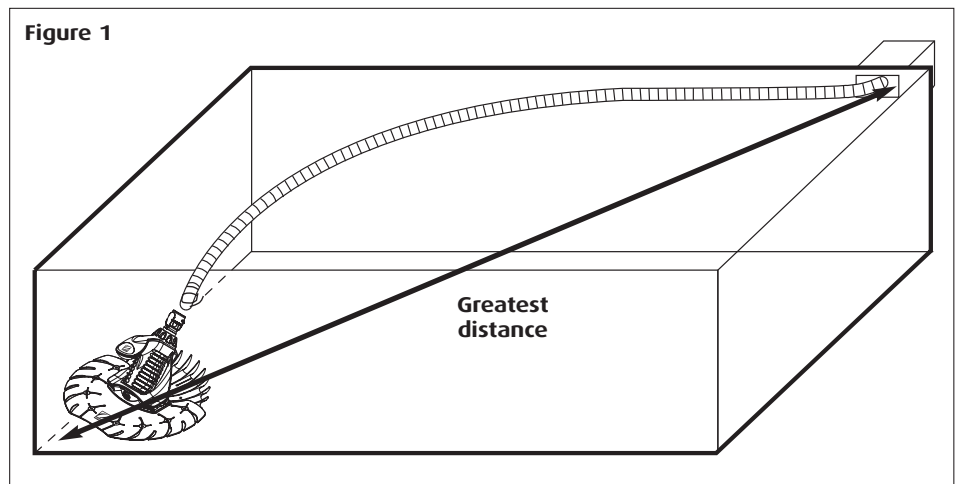

- Once you have calculated the total length, assemble your hose by inserting the 1 m sections into each other, male end connected to female end. In order to join them correctly, give the hose a quarter turn so as to position the latch in the notch.

You do not need to fit the tab in the last housing when using the cleaner at first (**Figure 2**).

3 / Connecting

Figure 3

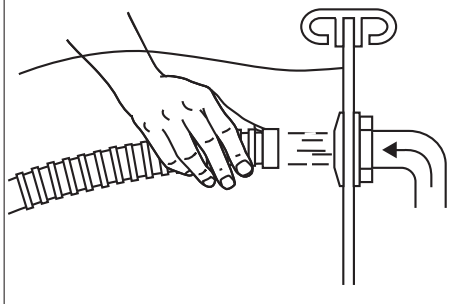

- Orient your pool inlet jets downward.
- Close the main drain of your pool.
- Activate the pool pump.
- Fill the T5 Duo hose with water using the flow generated by the return fitting and maintain the hose underwater for the remainder of the operations (**Figure 3**). The hoses must be emptied of all the air they contain in order for the cleaner to operate correctly. Once all the air has been removed, the robot will sink to the bottom of the pool.

IMPORTANT NOTE:

You can connect the T5 Duo hose to the suction point or to one of the skimmers in your pool. It is preferable to use a suction point situated at mid-distance of the main length of your pool.

CONNECTING TO THE VACUUM POINT OR TO THE SKIMMER

IMPORTANT: When connecting the last elements (last section of hose, automatic flow control valve, leaf trap*) ensure that these remain underwater so that there is absolutely no risk of air entering the system and draining the pump.

- Install the automatic flow control valve on the suction point using the weir adaptor.

Figure 4

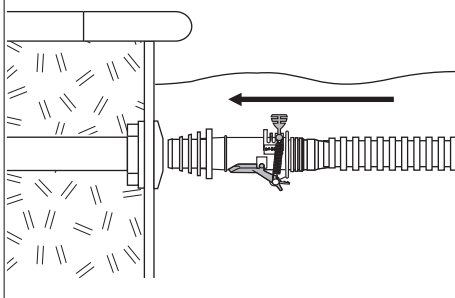

IMPORTANT:

The automatic flow adjustment valve is pre-set in the factory to number 3, the most suitable position for European pools. For an optimal performance from your cleaner, we recommend that you do not move the valve from this position.

Secondly, always check that the valve's dark grey flap is not held in the open position by the red lever – otherwise your cleaner cannot function (**Figure 4**).

- Connect the first 1 m section to the flow control valve, after filling it with water to remove the air.
- Connect the leaf trap* to the other end of the hose section after it too has been filled with water.

IMPORTANT: Make sure that the arrows on the automatic flow regulator valve and on the leaves basket* point toward the suction point and not toward the robot.

* optional, not sold with this product.

* optional, not sold with this product.

Connect the male part of the hose adaptor to the leaf trap*.

Check that there is no air in the hose assembly, then connect it to the vacuum point by joining the last hose section to the female part of the hose adaptor (**Figure 5**).

Connection to the vacuum point with leaf trap*

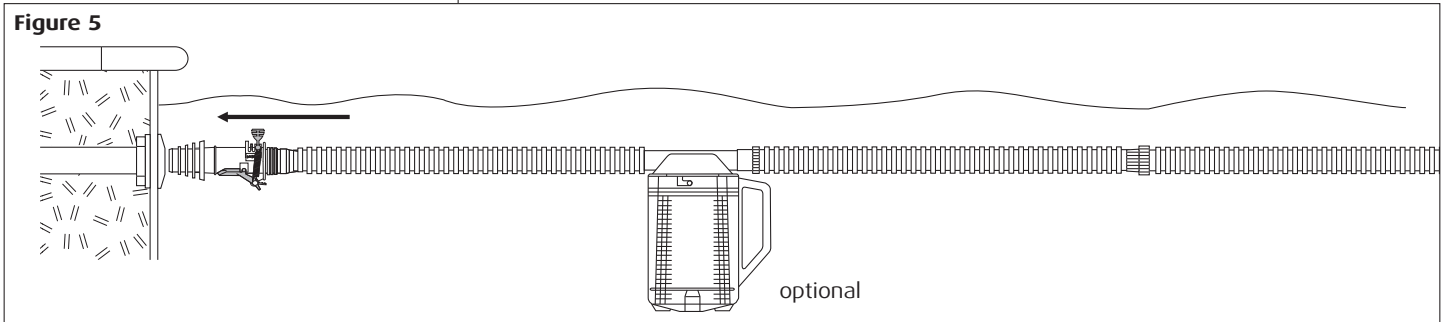

Connection to the skimmer with leaf trap*

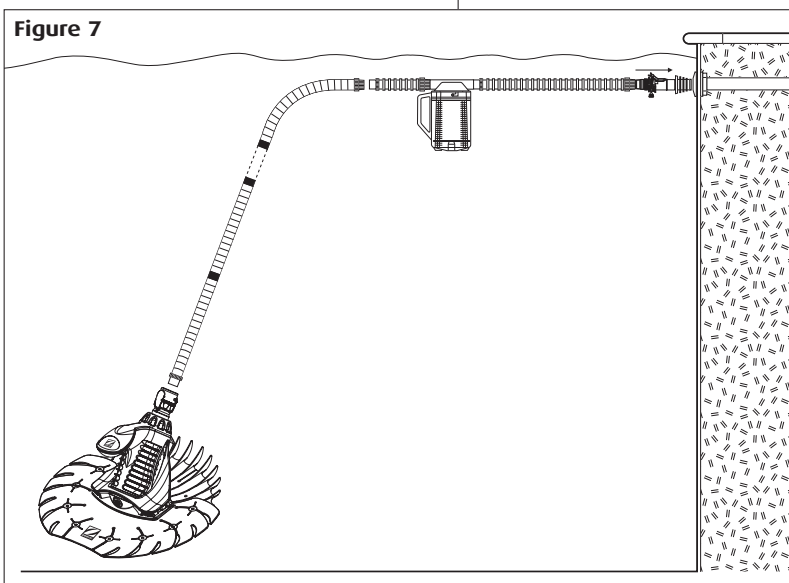
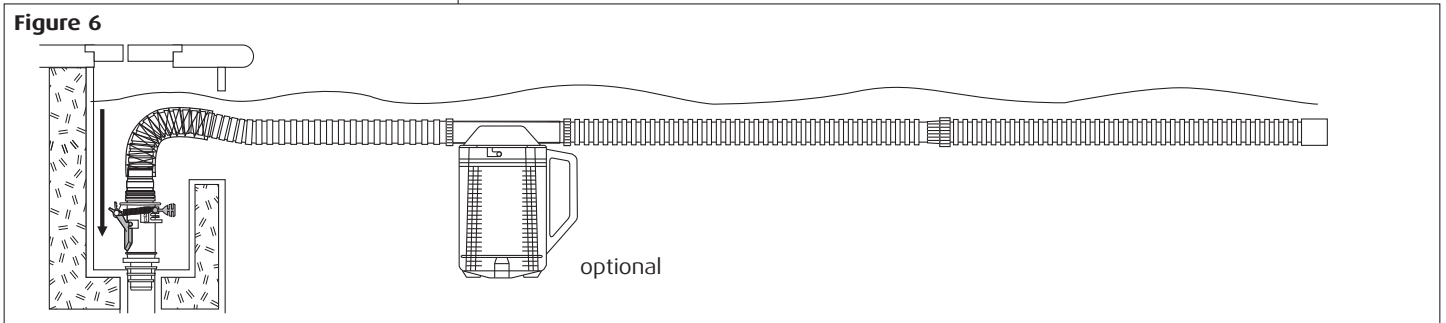

Check that there is no air in the hose assembly before connecting it to the skimmer.

Figure 7
Example with the connection to the vacuum point

4 / Flow test

Figure 8

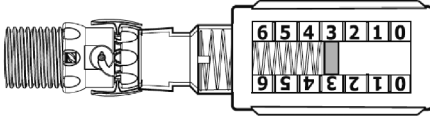

You can always check the flow rate, particularly if you have doubts about the suction power of your pump.

NB: all these operations must be carried out under water so that the pump does not take in air.

- Remove your T5 Duo from its hose, hold down the quick connector and connect it to the flow tester (**Figure 8**).

Note the zone indicated on the tester (Figures 13 to 15)

Figure 9

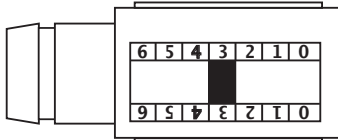

“Ideal”: The red indicator is on 3.

The flow is perfect to operate your T5 Duo. Remove the tester and reconnect the cleaner to the hose.

Figure 10

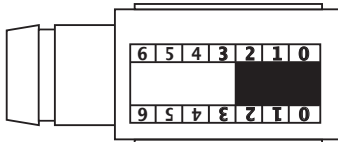

“Minimum”: The red indicator is below 3.

Increase the flow by closing the skimmer valve if the cleaner is connected to the suction point or by closing the suction outlet valve if the cleaner is connected to the skimmer, until the indicator on the tester is in the ideal zone. Remove the tester and reconnect the device to the hose.

Figure 11

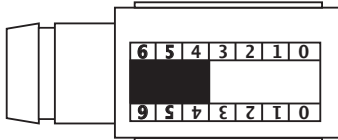

“Maximum”: The red indicator is above 3.

Reduce the flow by opening the skimmer valve if your cleaner is connected to the suction point or by opening the suction outlet valve if your cleaner is connected to the skimmer, until the indicator on the tester is in the ideal zone. Remove the tester and reconnect the cleaner to the hose.

5 / Hose and cleaner assembly

- Immerse the hose and the cleaner and assemble the elements underwater.

- Fit the assembled hose (see paragraph 2 page 16 : fitting the hose) with the quick connection fitting (**Figure 12**). To assemble them correctly make a quarter turn and position the tabs in one of the slots. You do not need to fit the tab in the last housing when using the cleaner at first.

Figure 12

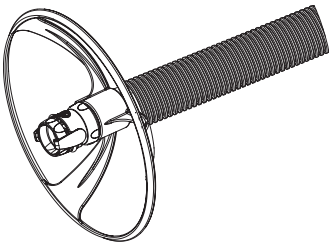

- If needed; if you have ladders or areas that might jam your cleaner, clip the non blocking wheel to the end of the hose (**Figure 12**).

Figure 13

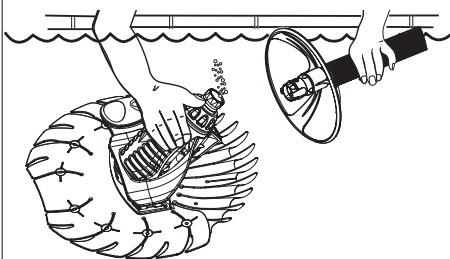

- Then clip the assembly to the cleaner nozzle (**Figure 13**).

- A counter-weight is supplied to be used when the T5 Duo tends to rise from the bottom of the pool (**Figure 14**).

Fit the counterweight to the end of the first hose section at about 1 metre from the appliance (**Figure 15**) then make sure that the disk remains on the bottom of the pool when the appliance is operating.

Figure 14

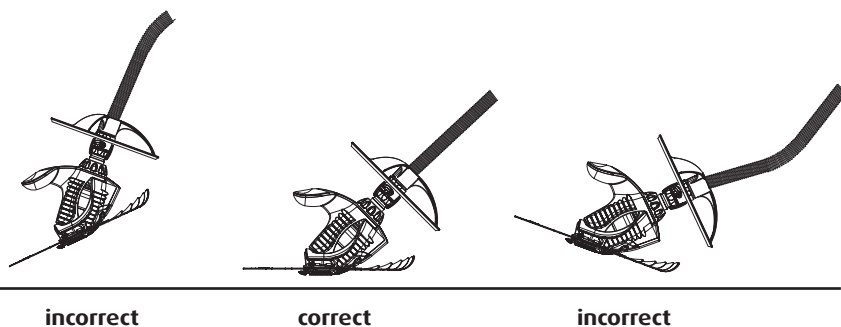
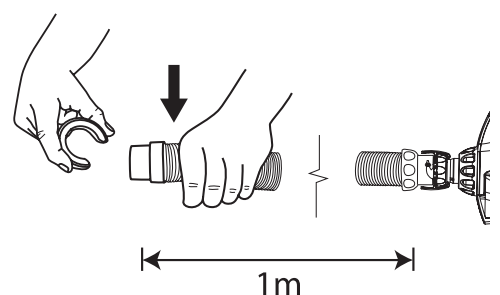

Figure 15



6 / Troubleshooting

The T5 Duo is not operating correctly

- Control the flow using the flow tester.

If the flow is insufficient:

- Check that the valve of the main drain is closed.
- Check that the pump pre filter and basket are clean.
- Check that the hose and automatic adjustment valve are correctly connected.

IMPORTANT:

Always check that the dark grey flap gate on the valve is not held in the open position by the red lever – otherwise your pool cleaner cannot operate.

If the water flow is correct:

- Check that the cleaner suction inlet is not clogged up with debris.
- Is the T5 Duo Diaphragm damaged?
(see pages 22 and 23)

The T5 Duo doesn't clean all the zones of your swimming pool

- In order to ensure complete cleaning of the pool, the total time may be split into periods. For example, 6-hour filtration performed as 3 times 2 hours will provide better coverage than a single 6-hour filtration.
- Is your hose long enough: add hose sections if necessary.
- Have you oriented all inlet jets downwards?
- Is the hose in perfect condition?

The T5 Duo does not stay on the bottom of the pool

- Check the position of the float on the hose (see figure 14 page 20).
- Test the flow and increase it if necessary (see page 19).

The T5 Duo stays stuck at the stairs of your pool ladder

- Plug the hose in the suction fitting situated furthest from the stairs.
- Modify the hose length by adding or removing a section.
- Orient the inlet jets so as to push the hose away from the steps.
- If necessary add the deflector wheel.

The T5 Duo moves slowly and air bubbles form at the level of the suction outlet

- Check the air tightness of the circuit: between all hose sections, between the hose and the valve, between the valve and the skimmer.

The T5 Duo moves above the waterline

- Reduce the flow (see page 19).

The T5 Duo stays stuck at the main drain plug

- Close the main drain valve.

7 / Cleaning, replacing the Diaphragm

Figure 16

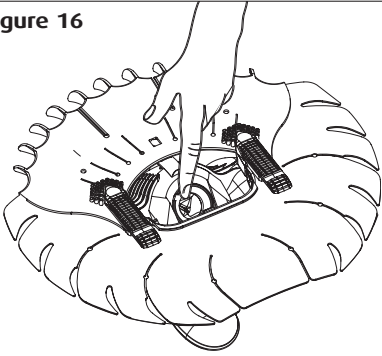

Cleaning the Diaphragm

If the cleaner stops, check the diaphragm for blockage.

- Turn cleaner over (**Figure 16**).
- Inspect diaphragm and push through debris or obstacles to clear.

If not blocked, check the diaphragm for wear or damage.

Removing the Diaphragm

- Unscrew the casing (**Figures 17 and 18**).
- Unscrew the handle (**Figure 19**), release the inner tube then remove the diaphragm (**Figure 20**).
- Check the diaphragm for possible traces of wear and rinse profusely with water. If necessary replace with a new diaphragm.

Figure 17

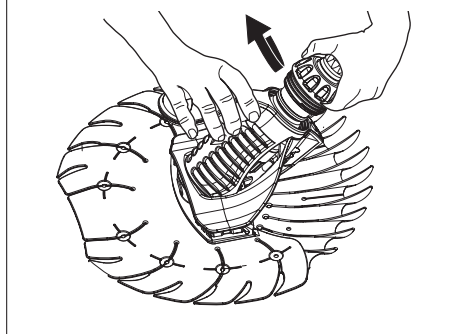

Figure 18

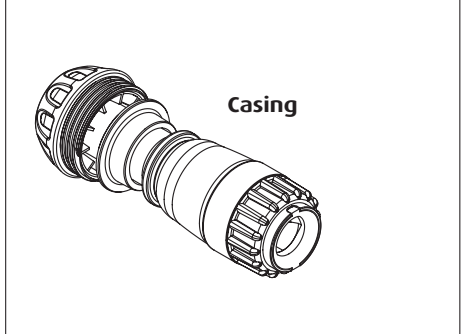

Figure 19

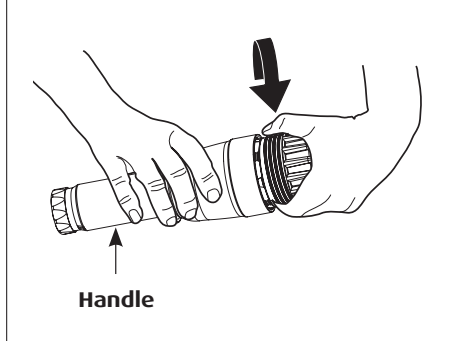
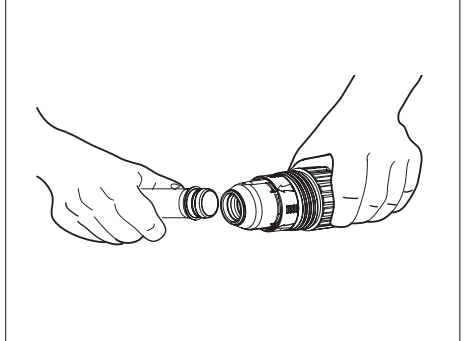

Figure 20



Reassembling the Diaphragm

- Insert the diaphragm back on the inner tube.
- Insert the diaphragm/inner tube assembly into the upper part of the cassette. Align the stop markers on the diaphragm with the notches and pull gently on the inner tube (without twisting) until the edge of the diaphragm becomes visible (**Figures 21 and 22**).

Figure 21

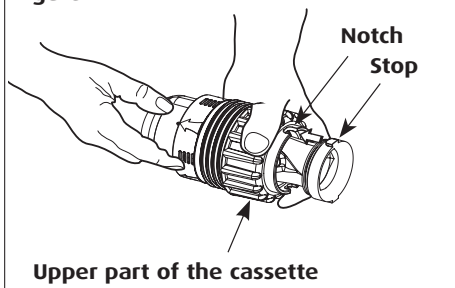

Figure 22

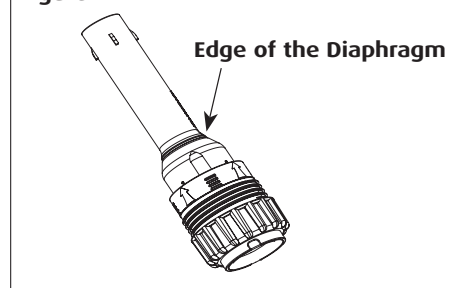
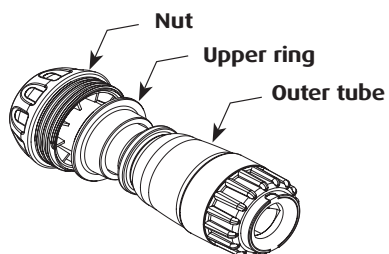

Figure 23



- Screw the handle back onto the upper part of the cassette.

- Assemble the casing then slide the ring and the nut onto the handle (**Figure 23**).

Figure 24

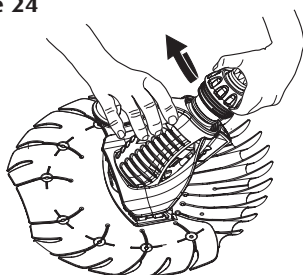

- Insert the engine into the body and thread the handnut down tight (**Figure 24**).

Figure 25

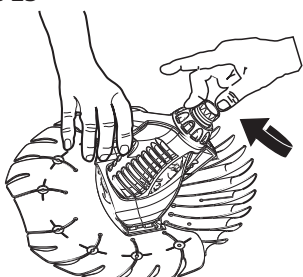

- Make sure the extension tube swivels freely by spinning it (**Figure 25**).

8 / Warranty

Conditions:

All our technical experience and concern for quality have been used in the manufacture of ZODIAC automatic pool cleaners. All our cleaners are subject to quality control tests and are guaranteed against manufacturing defects. If, in spite of all the care and know-how used in the manufacture of our products, you were to have need of the guarantee, please be aware that it only applies to the free replacement of faulty parts. Our models are regularly updated and improved to make the most of technological advances. It is understood that these improvements cannot be added to previous models within the context of our guarantee.

For any warranty issue, please contact your local dealer.

Period of guarantee:

The period of the guarantee is fixed at 3 YEARS for the T5 Duo, from the date of invoicing the first user.

The T5 Duo cleaner benefits from an unconditional guarantee of 3 years: whatever the causes of its deterioration, it will be mended or exchanged within a period of 36 months following your purchase.

Under no circumstances can repairs or replacements made as part of the guarantee prolong the appliance's guarantee period.

Object of the guarantee:

During the guarantee period defined above, any part recognised as faulty will be mended or exchanged by the manufacturer with a new part or in correct operating condition. This guarantee covers all faults relating to conformity existing at the time the article is delivered.

In the event of a return to the workshop, return transport costs will be the responsibility of the user, but labour costs remain the responsibility of the retailer.

The immobilisation and the prevention of possession of an appliance in the event of any necessary repairs cannot give rise to compensation. In all circumstances, the legal guarantee of the seller continues to be applied in accordance with article 4 of decree n° 78- 464 of 24 March 1978. The legal guarantee of article 1641 of the civil code is applied.

THIS GUARANTEE APPLIES PENDING STATUTORY PROVISIONS COMING INTO FORCE THAT HAVE NOT AS YET BEEN PUBLISHED AT THE TIME OF THESE CONDITIONS GOING TO PRESS.

Transport damage:

Appliances always travel at the risk and peril of the user. It is up to the user, before taking delivery of the appliance, to check that it is in perfect condition. Under no circumstances can we be held responsible for transport damage.

Warning

WARNING: USE OF THE T5 DUO IN A VINYL LINER POOL

Certain vinyl liner patterns are particularly susceptible to rapid surface wear or pattern removal caused by objects coming into contact with the vinyl surface, including pool brushes, pool toys, floats, fountains, chlorine dispensers, and automatic pool cleaners. Some vinyl liner patterns can be seriously scratched or abraded simply by rubbing the surface with a pool brush.

Ink from the pattern can also rub off during the installation process or when it comes into contact with objects in the pool.

Zodiac® is not responsible for, and the Limited Warranty does not cover, pattern removal, abrasion or markings on vinyl liners.

Zodiac® can not be held responsible for any damage to the swimming pool lining (vinyl liner, reinforced PVC, etc.) occurring as the result of an excessive level of disinfectant (chlorine, brome, active oxygen, etc.) or an incorrect pH value (outside the range of 6.8 minimum and 7.6 maximum). Any such damage will be excluded from the guarantee.

RISK OF SUCTION ENTRAPMENT HAZARD, WHICH, IF NOT AVOIDED CAN RESULT IN SERIOUS INJURY OR DEATH.

Do not block the suction fittings with any part of your body.

Do not expose your hair, loose clothing, jewelry, etc. to any suction outlet fittings in the pool/spa.

For further information please contact your retailer.

Register your product on our website:

- You will be the first to be informed of new Zodiac products and special offers.
- You can help us to constantly improve our product quality.

Zodiac Pool Care Europe
Bd de la Romanerie - BP 90023
49180 St Barthélémy d'Anjou - FRANCE
www.zodiac-poolcare.com