

Swimming Pool Heat Pump

INSTALLATION AND USER MANUAL

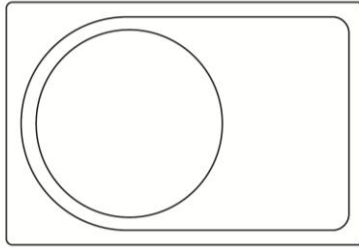

Thank you for choosing our product and trusting our company.

This manual is to provide you with necessary information for optimal use and maintenance, please read it carefully and keep it for subsequent use.



Content

I. Introduction

<i>Safety precaution</i>	1
<i>Important features of this product</i>	1
<i>Parameters of product range</i>	3

II. Installation Guide

<i>Transport it in proper manner</i>	5
<i>Determining Optimum installation position</i>	5
<i>Water pipe connection</i>	8
<i>Electric connection</i>	8
<i>Trial after first installation</i>	10
<i>Assemble to wire LED</i>	11
<i>Heating priority</i>	15

III. Operation guide

<i>LED controller</i>	16
<i>Permanent Display</i>	17
<i>Common setting</i>	17
<i>Automatic on/off</i>	18

***IV. Maintenance*..... 19**

V. Trouble shooting

<i>Common faults</i>	20
<i>Failure code</i>	21

I. Introduction

Safety precaution

Caution: Danger of electric shock

Always switch off power supply before working on the heat pump and stop the hydraulic circuit.

- The swimming pool heat pump must be installed by a qualified electrician.
- Always install a differential protective device with a sensitivity of 30 mA on the distribution unit before the electrical box.
- Always fit a circuit breaker for all active conductors on the power supply of the box.
- In the event of abnormal behavior (noise, smell, smoke), cut off the power supply immediately and contact your reseller. Do not attempt to repair the system yourself.
- Keep the main power supply switch far from children.
- Rotating parts: Never remove the grid from the fan. Never place your hand or any other object in the air inlet or outlet of the heat pump.

Important features of this product

This swimming pool heat pump is equipped with safeguards that will stop operation to protect your unit automatically and display error code on the LED controller in case of some events as following:

Water Flow Switch

The water flow switch contacts close when pressure is applied as pool water flows through the titanium heat exchanger. Low flow rates as well as no flow will let these contacts open and this will cause the unit to shut down. The LED display will read “EE3” if the water pressure is not sufficient.

High / Low Refrigerant Pressure Switches

- The high-pressure switch senses the refrigerant pressure in the sealed refrigeration system and shuts the heat pump down in the event unsafe operating pressures are reached. The heat pump will automatically reset after the system pressure drops back to normal operating pressures. When this switch is tripped, digital displays will read “EE1”
- The low-pressure switch senses the refrigerant pressure in the sealed refrigeration system to protect against certain conditions that could be detrimental to compressor life. The switch shuts the unit down in the event of loss of refrigerant or not enough refrigerants. The switch automatically resets when the pressure rises to normal operating pressures. The display will show “EE2” if this switch is tripped.

Low Ambient Temperature

If the air outside the heat pump is not warm enough to produce heat, the system will shut down. The actual point at which your unit will shut down due to low temperature varies depending on current weather conditions, the amount of sunlight reaching the heat pump. The shutdown can occur anywhere within a wide range of temperatures, usually below 0 degrees. A shutdown occurs because low temperatures will activate the systems low-pressure safeguard switch (digital controller will display a code “PP7”.) The unit will start up again when the temperature has raised enough to reset this switch.

Time Delay

All models use a 3-minute time delay to prevent repeated tripping of the compressor thermal overload, which is caused by attempting startup before system pressures are equalized. Any interruptions, outside of power loss, will result in a 3-minute time delay.

Parameters of product range

Specification

Model		PH(C)18L	PH(C)25L	PH(C)35L	PH(C)50L	PH(C)65L	PH(C)65Ls	PH(C)80Ls	
Function	Heating capacity Kw (air 26°C, water 26°C)	7.5	10	13.5	17.5	26	28	33	
	C.O.P. (air26°C,water26°C)	6.7	6.6	7	6.7	6.6	6.8	6.8	
	Heating capacity Kw (air 15°C,water 26°C)	5	7	10	12	16.5	17.5	22	
	C.O.P. (air15°C,water26°C)	4.8	4.7	5	4.7	4.5	4.8	4.6	
	Cooling capacity Kw (air 35°C,water 28°C)	4.3	6	8	10	15	16	20	
	C.O.P. (air35°C,water28°C)	4	4	4	3.8	4	4.2	4	
	Power supply	220-240V/1Ph/50Hz					380-415V/3Ph/50Hz		
	Rated Input power Kw	1.04	1.49	2.0	2.55	3.67	3.65	4.78	
Rated Input current A	4.7	6.8	9.1	11.6	16.7	5.5	7.2		
Advised water flux m ³ /h	3-4	4-6	5-7	6.5-8.5	8-10	8-10	10-12		
Water pipe in-out spec mm	50	50	50	50	50	50	50		
Net weight / Gross weight Kg	40/47	50/59	68/77	78/88	128/145	128/145	128/145		

*C.O.P: Coefficient of performance

Note:

1. Mode PH- is heating only, PHC is heating and cooling optional and S refers to three-phase. For heating only, please ignore the parameters of cooling capacity and cooling C.O.P.other parameters are the same with the heating and cooling type
2. This product can work well under air temp +0 °C~43°C. Performance cannot be guaranteed outside the operating ranges and must take account the exterior conditions of use identified to select suitable mode (such as location, area of swimming pool, and numbers of swimmer.)
3. Above parameters are subjected to adjustment periodically for technical improvement with further notice. Please refer to nameplate on each machine for accurate information.
4. For machine to Australia, the water pipe in-out spec is 48mm.

Dimension:

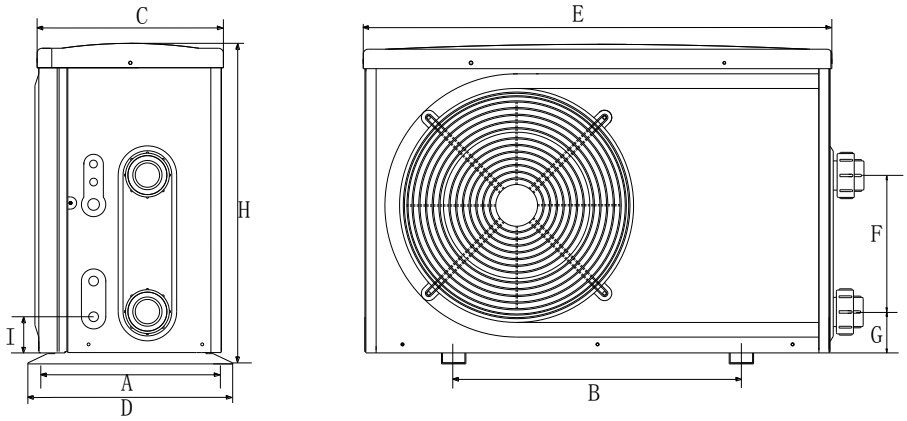

Size(mm) Name Model	A	B	C	D	E	F	G	H
PH(C)18L	317	429	302	340	800	200	84	558
PH(C)25L	317	590	302	340	960	280	84	658
PH(C)35L	398	590	382	420	960	280	84	658
PH(C)50L	398	590	382	420	960	380	84	758
PH(C)65L	507	790	492	530	1160	600	84	958
PH(C)65Ls	507	790	492	530	1160	600	84	958
PH(C)80Ls	507	790	492	530	1160	600	84	958

● Above data is subject to modification without notice

II. Installation Guide

Attention!

This swimming pool heat pump must be installed by a skilled team.

Transport it in proper manner

1. Transport it in original package.
2. When moving the machine, do not lift the water nozzle since the titanium heat exchanger in side the machine will be damaged. Please refer to the following wrong operation picture:

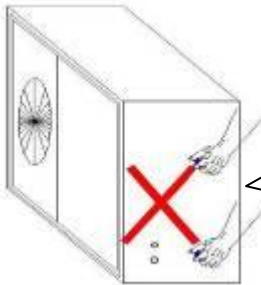

!!Warning:

Because the machine is very heavy, the water nozzle can not bear to be lifted during transit or installation

The manufacturer cannot accept responsibility for damage incurred or repairs necessitated due to improper handling of our equipment.

Determining Optimum installation position

The location of the swimming pool heat pump is very important for efficient operation, think about the following factors when choose the proper place:

- ◇ Avoidance of air recirculation
- ◇ Easy for wire and pipe connection and Water pipe line of long water lines (not longer than 10m.) from heater to pool.
- ◇ Easy for maintenance.
- ◇ Drainage of condensation.

Pay attention to the following points:

1. The heat pump must be installed OUTSIDE in a well ventilated place to avoid air recirculation or in a place with adequate room area both for installation and maintenance. Please refer to the following illustration:

A minimum of 300mm of clearance from walls, shrubbery, equipment, etc. is required around the entire pump circumference. This allows for ample air intake. No less than 800mm clearance on the air outlet is required to prevent re-circulation of air. We recommend not placing the unit underneath eaves, decks, or porches, as this causes recirculation of discharged air, or the efficiency of the heater will be reduced or even stopped.

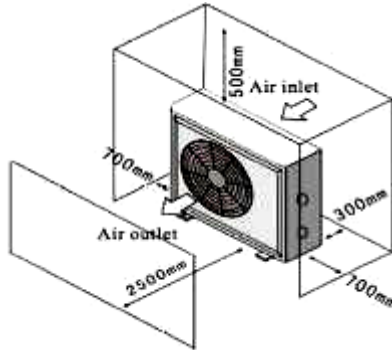

Wrong installation

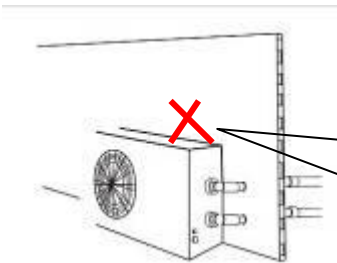

!!Warning:
Don't install the heat pump close to a wall or plants. And Never inside a closed building!

2. The heater should be located on a solid, level and non-corrodible structure that is capable of supporting the weight of the heat pump. It must be fixed by bolts (M10) to concrete foundation.

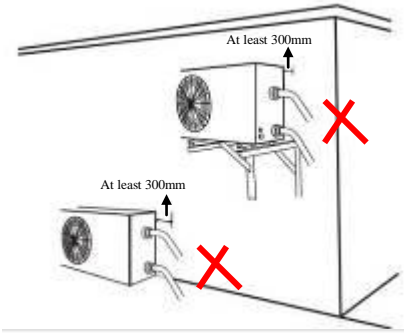

!!Warning:

The machine must not be hung onto the wall **with soft pipe** since the inlet/outlet union on the machine can't hold weight.

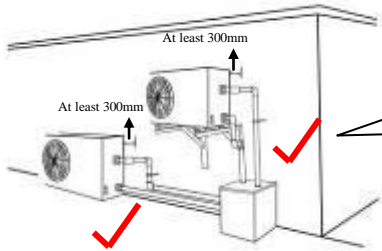

The machine must always be connected **with hard pipe!**

3. The heat pump should be far from any source of combustibles and corrosive material to avoid any damage to this unit.

Never place heat pump near sprinkler systems, evaporation of acid or alkaline gas. If you live in an oceanfront area, the heat pump should be placed out of direct spray of sand and salt, since this will also clog, damage, and corrode the unit. You may consider protecting your heat pump by planting shrubbery or a privacy fence between the unit and the prevailing beachfront wind.

4. When the machine is running, there will be condensation water discharged from the bottom. Make sure there is enough space for water drainage.

TIPS: HEAT PUMPS GENERATE WATER CONDENSATION DURING NORMAL OPERATION. THIS SHOULD NOT BE MISTAKEN FOR A LEAK IN THE UNIT.

Water pipe connection

- The water flow through this machine needs to be driven by an appended water pump (Prepared by the user). The recommended pump specification-flux is shown on the product specification and Max. lift $\geq 10\text{m}$;
- Pipe length between heat pump and swimming pool should not be longer than 10m.

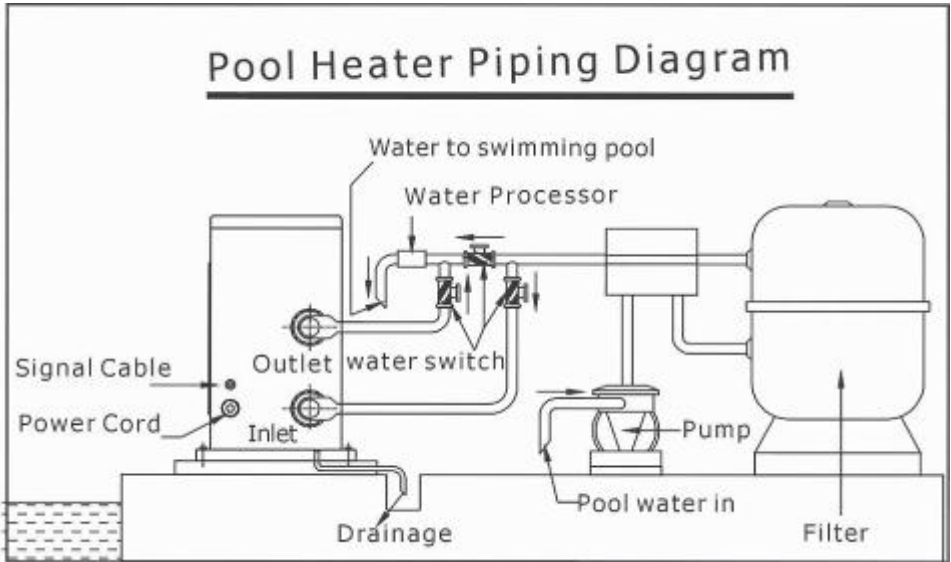

Noted: The drawing is just for demonstration, and layout of the pipes for reference.

Electric connection

- Wiring must be handled by a professional technician according to the circuit diagram as following.
- Connect the heat pump to appropriate power supply and the voltage should comply with the rated voltage of each model stated on the specification.
- Make sure the machine is ground well.
- Always put leakage protector according to the local code for wiring (leakage operating current $\leq 30\text{mA}$).
- Protect the circuit with a suitable circuit breaker or fuse.

A.For power supply:220~240V 50Hz

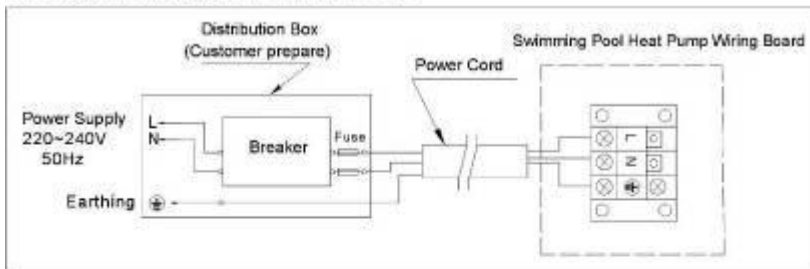

B.For power supply:380V 50Hz

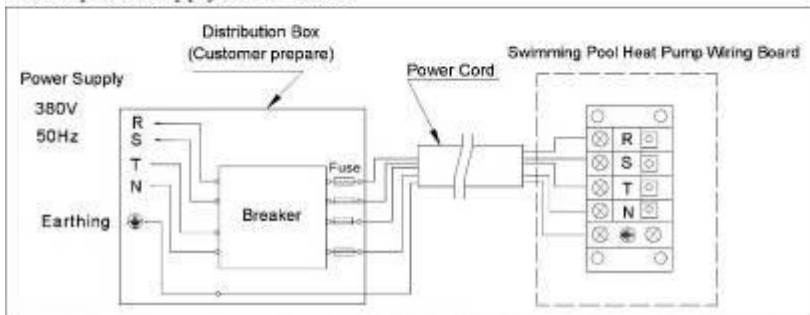

Attention: The swimming pool heater must be earthed well.

Recommendation for protecting devices and cable specification

MODEL		PH(C)18L	PH(C)25L	PH(C)35L	PH(C)50L	PH(C)65L	PH(C)65Ls	PH(C)80Ls
Breaker	Rated Current A	15	15	20	25	40	15	20
	Rated Residual Action Current mA	30	30	30	30	30	30	30
Fuse A		15	15	20	25	40	15	30
Power Cord (mm ²)		3×2.5	3×2.5	3×2.5	3×4	3×6	5×2.5	5×4
Signal cable (mm ²)		3×0.5	3×0.5	3×0.5	3×0.5	3×0.5	3×0.5	3×0.5

※ Above data is subject to modification without notice.

Note: The above data is adapted to power cord ≤ 10 m .If power cord is >10 m, wire diameter must be increased. The signal cable can be extended to 50 m at most.

Attention:

Always Start the water pump **before** turning on this machine
Turn off this machine **before** turning off the water pump.

Inspection before connecting power supply

- Check the installation of the whole machine and the pipe connections according to the pipe connecting drawing.
- Check the electric wiring according to the electric wiring diagram, and ground well.
- Make sure no blockage on the air inlet and outlet, or the efficiency of the heater will be reduced or cause machine to stop operation.

Trial after connecting power supply

- Connect the machine with electric power supply, then relative information will display on the LED controller.
(For Detail operation of LED controller, please refer to Chapter "Operation guide".)
- Start the water pump before turning on the Machine to avoid any damage.
- Press power on/off on LED controller to turn on/off machine.
- During the first start of machine, please check if there is any water leakage in the piping connection system. Then set suitable temperature.
- After the swimming pool heater runs, check if there is any abnormal noise or smell.

In any abnormal situation, such as serious noise, smell or smoking please cut the power supply immediately and inform resellers, never try to repair it by yourself.

Special cases:

- In the event of an unexpected power cut, the heat pump will automatically restart. Check the setting and adjust if necessary.
- In the event of an expected power cut, switch off the heat pump. When power is restored, switch on the pump, check the settings and adjust if necessary.
- Always switch off the machine in stormy weather.

Assemble to wire LED

Notice: The assembling must be operated by a qualified electrician. And in case of electric shock, the machine' s power must be cut off before assembling

- 1) **Open the top cover panel and the electric box cover.**
- 2) Open wire box, pull out the LED plug as chart 1.
- 3) Pull out the LED terminal from the PCB and move the LED wire out from electric box.

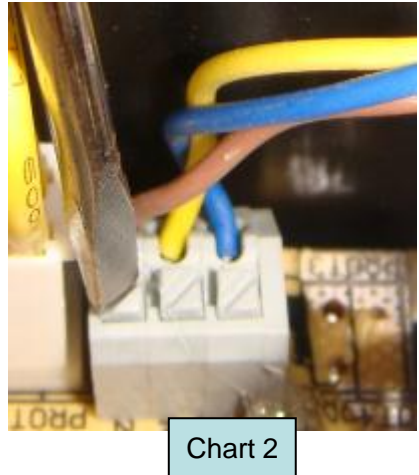
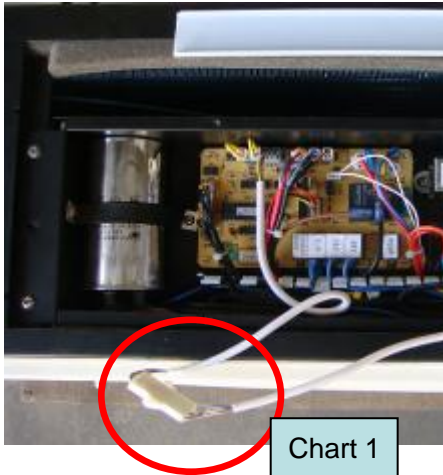

Remove the LED panel from the base with a flt tool.





Unscrew the bolt and dismantle LED panel. Then refix the cover box.

Chart 1



1. Unscrew the plastic nut of the 2nd terminal as chart 1.
2. Drill the LED wire through the plastic nut and the 2nd terminal hole as chart 2.

3. Drill through the LED wire to the electrib cox hole as chart 3.

Chart 2



Chart 3



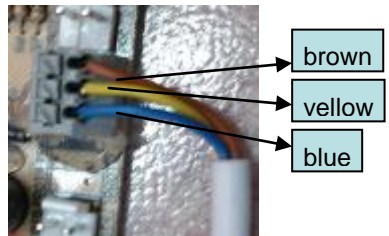
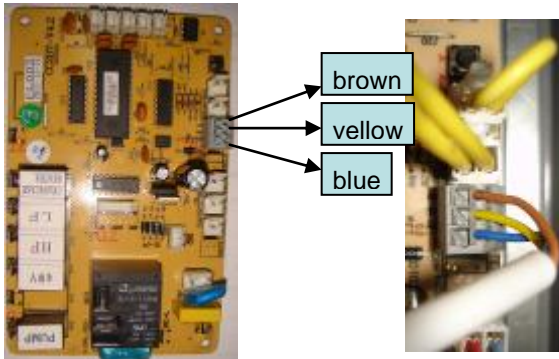

Plug the LED wires to the PCB and check if it's fixed. Attention: don't plug with wrong color wires.

- Put LED wire to the wire box well and cover it. Don't let the box cover push the wire.
- Pack the LED wires well like picture and don't let the wires touch the piping system.
- Please screw the plastic nut tightly.



1. Install the LED to the wall;
2. Inspection of the LED assembling: Start the machine and check whether LED display water temperature in a few seconds. If LED display 8888, please double check your connection.



Heating priority

1.

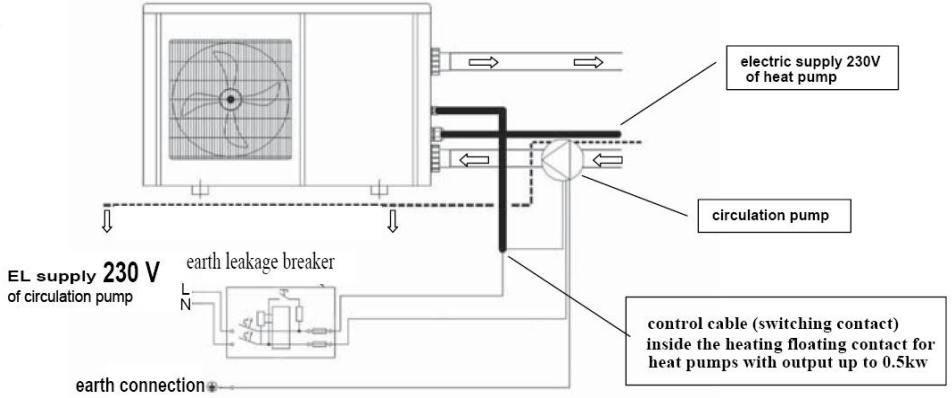

2.

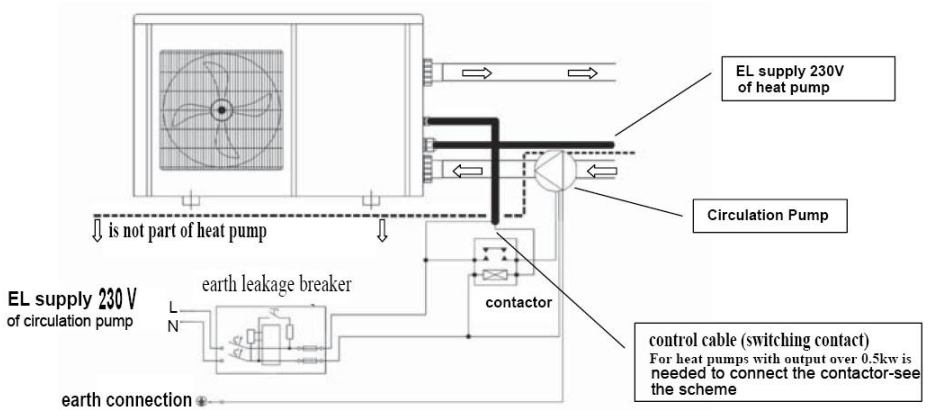



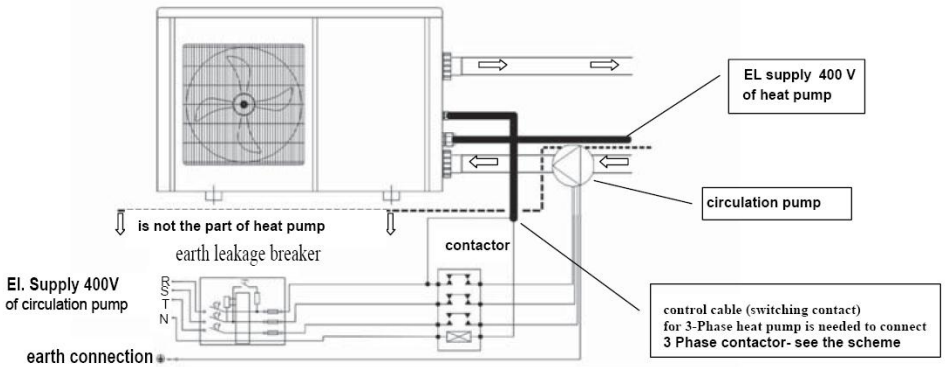





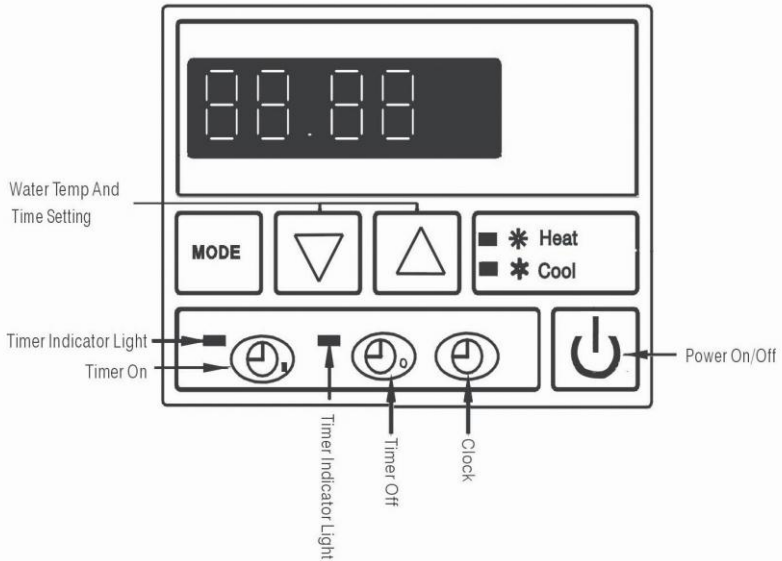



3.



III. Operation guide

LED controller



-  Power on/off
-  **CLOCK** Set local time.
-  **TIME OFF** Set the time required machine auto-stop.
-  **Light A** Shows the auto-stop time being set.
-  **TIME ON** Set the time required machine auto-work.
-  **Light B** Shows the auto-work time being set.
-  **COOL** Shows the cool mode (only available on the heat and cool machine)
-  **HEAT** Shows the heat mode
-  **MODE Key** Heat or cool mode selection (only available in heat and cool machine)
-  **Down-ALLOW** Set required temperature and time
-  **UP-ALLOW** Set required temperature and time
-  **LED screen** Display time, temperature and machine failure code

Permanent Display

- A. The LED screen will display **Time** when the machine is turned off.
- B. The LED screen will display **Water temperature** in swimming pool when the machine is turned on.

Common setting





1. Heat/Cool Mode

Press the Mode button to switch from one mode to another.

(Available only in heat and cool machine.)









2. Required pool water temperature

It can be adjusted both when the machine is on or off.

- A. Press UP-ALLOW key  or DOWN-ALLOW key  to set to your required pool water temperature.
- B. The numbers in the LED screen will flash during your operation.
- C. After five seconds, it will stop flashing and be saved, the LED screen will return to the permanent display.
- D. When you want to check the temperature, press UP-ALLOW key  or DOWN-ALLOW key  again to get it.

3. Time setting







It can be adjusted both when the machine is on or off.

- A. Press  key to set time according to your local time.
- B. Time on the LED screen flashes.
- C. Press  again then press UP-ALLOW key  or DOWN-ALLOW key  to set hour.
- D. Before it stops flashing, press  and then press UP-ALLOW key  or DOWN-ALLOW key  to set minutes
- E. After setting, press  and the water temperature will appear. 30 seconds later, it will stop flashing and the LED screen will return to the permanent display.









Automatic on/off

This function can make the machine work or stop automatically in your required time.



1. Time on

- A. Press  to set timer on.
- B. When the indicator light is on and the time is twinkling, press  again to set hour. Use  and  to adjust.
- C. Before the twinkling stops, press  to set minute .Use  and  to adjust.
- D. After adjusting, press “TIMER ON” and water temperature will be seen. 30 seconds later, the controller display will be back to the normal mode.

2. Time off

- A. Press  to set timer off.
- B. When the indicator light is on and the time is twinkling, press  again to set hour. Use  and  to adjust.
- C. Before the twinkling stop, press  to set minute .Use  and  to adjust.
- D. After adjusting, press  and water temperature will be seen. 30 seconds later, the controller display will be back to the normal mode.

3. Cancelling the automatic mode

- A. Press  or  to cancel timer on and off.
- B. When the number is twinkling, press . When timer indicator light is off and LED shows water temperature, the timer on and off is canceled.
- C. 30 seconds later, the controller display will be back to the permanent display.

IV. Maintenance

Caution: Danger of electric shock

“Cut off” power supply of the heater before cleaning, examination and repairing

- A. In winter season when you don't swim:
 - 1. Cut off power supply to prevent any machine damage
 - 2. Drain water clear of the machine.

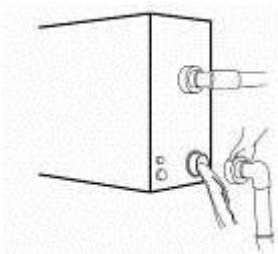

!!Important:

Unscrew the water nozzle of inlet pipe to let the water flow out.

When the water in machine freezes in winter season, the titanium heat exchanger may be damaged.

- 3. cover the machine body when not in use.

- B. Please clean this machine with household detergents or clean water, NEVER use gasoline, thinners or any similar fuel.
- C. Check bolts, cables and connections regularly.

V. Trouble shooting

Common faults

	Phenomenon	Possible reason
Not failure	A. Noticeable White vaporous cold air or water. B. Popping sound	A. The fan motor stops automatically for defrost. B. There will be sound from the solenoid valve when machine starts or ends to defrost. C. During machine working or just stopping, a sound like water flow, in 2~3 minutes of starting the machine. This Sound comes from refrigerant flowing or water drainage during dehumidification. D. The popping sound during the operation is caused by expand on heating and contract on cooling of the heat exchanger when temperature varies.
	Automatic start or stop	Check whether there is mal-function on the timer.
Recheck	Heat pump does not run	A. Power supply failure B. Check manual power supply switch to make sure it is on. C. Fuse burned. D. If machine auto- protector has started (check failure code display on controller). E. Check whether machine automatic on or off was set.
	Running but not heating or cooling	Check if there is blockage on air inlet and outlet of the unit.

Note: If the following conditions happen, please stop the machine and cut off the power supply immediately, then contact your dealer:

The fuse is frequently broken or leakage circuit breaker jumped.

Failure code

NO.	Failure code	Failure description	Action
1	EE 1	High pressure protection	Contact your dealer.
2	EE 2	Low pressure protection	Contact your dealer.
3	EE 3	Low water pressure protection	1. Check if there is no water through the machine; make sure the pump is on. 2. Or contact your dealer.
4	EE 4	A.Single phase machine : failure connection due to loose wire terminal of PROT2 on the PC board B.Three phase machine : 3 phase sequence protection	Contact your dealer.
5	PP 1	Pool water temp sensor failure	Contact your dealer.
6	PP 2	a. Heat only type : Exhaust temp sensor failure b. Heat and cool type: Cooling coil pipe temp sensor failure	Contact your dealer.
7	PP 3	Heating coil pipe temp sensor failure	Contact your dealer.
8	PP 4	Gas return temp sensor	Contact your dealer.
9	PP 5	Air temp sensor	Contact your dealer.
10	PP 6	Compressor exhaust overload protection	Contact your dealer.
11	PP 7	When the temperature < 0°C,auto stop for protection (Not Failure)	Machine Auto-protection