

# SWIMMING POOL HEAT PUMP UNIT

## Installation & Instruction Manual

### Duratech ® - series



# CONTENTS

<b>1. Preface</b>	<b>3</b>
<b>2. Specifications</b>	<b>4</b>
2.1 Performance Data of swimming Pool Heat Pump Unit	4
2.2 Dimensions for Swimming Pool Heat Pump Unit	5
<b>3. Installation and Connection</b>	<b>5</b>
3.1 Installation of System	6
3.2 Swimming Pool Heat Pumps Location	7
3.3 How Close to your Pool?	7
3.4 Swimming Pool Heat Pumps Plumbing	8
3.5 Swimming Pool Heat Pumps Electrical Wiring	9
3.6 Initial Start-up of the Unit	9
<b>4. Usage and operation</b>	<b>10</b>
4.1 The Functions of the LED Controller	10
4.2 How to Set Operation Parameters	10
4.3 How to Choose Mode	11
4.4 How to Know the Current Status	11
4.5 CLOCK setup	12
4.6 TIMER ON setup	12
4.7 TIMER OFF setup	12
4.8 Operation Data Setting	13
<b>5 Maintenance and Inspection</b>	<b>14</b>
5.1 Maintenance	14
5.2 Trouble Shooting Guide	14

# 1. PREFACE

---

- In order to provide our customers with quality, reliability and versatility, this product has been made to strict producing standards. This manual includes all necessary information about installation, debugging, discharging and maintenance. Please read this manual carefully before you open or maintain the unit. The manufacturer of this product will not be held responsible if someone is injured or the unit is damaged, as a result of improper installation, debugging or unnecessary maintenance. It is vital that the instructions within this manual are adhered at all times. The unit must be installed by qualified personnel.
- The unit can only be repaired by a qualified installer, centre, personnel or an authorized dealer.
- Maintenance and operation must be carried out according to the recommended time and frequency, as stated in this manual.
- Use genuine standard spare parts only.  
Failure to comply with these recommendations will invalidate the warranty.
- The Swimming Pool Heat Pump Unit heats the swimming pool water and keeps the temperature constant.

**Our heat pump has following characteristics:**

## **1 Durable**

The heating exchanger is made of PVC & Duranium<sup>®</sup> tube, which can withstand prolonged exposure to swimming pool water.

## **2 Operation flexibility**

The unit is able to work in low ambient temperatures due to its hot gas defrost cycle. The unit is also capable of cooling the poolwater.

## **3 Quiet operation**

The unit comprises an efficient rotary/ scroll compressor and a low-noise fan motor, which guarantees its quiet operation.

## **4 Advanced controlling**

The unit includes a micro-computer controller, allowing all operation parameters to be set. Operation status can be displayed on the controller with LED display. Remote controlling can be chosen as future option.

## 2. SPECIFICATION

### 2.1 Performance data of Swimming Pool Heat Pump Unit

Unit	Model	DURA -3	DURA -6	DURA -8	DURA -12	DURA -17	DURA -21	DURA -21T	DURA -25T
Heating Capacity	kW	3,0	6,0	8,5	12,0	17,5	21,0	21,0	25,0
	BTU/h	10200	21000	30000	41000	60000	72000	72000	85300
Cooling capacity	kW	2,2	4,8	6,8	9,6	14,0	16,7	16,8	20,0
	BTU/h	7500	16500	23500	33000	48000	57000	57000	68500
Power Input	kW	0,8	1,2	1,7	2,4	3,5	4,3	4,2	5,0
Performance	C.O.P.	3,75	5,0	5,0	5,0	5,0	4,9	5,0	5,0
Maximum volume	m <sup>3</sup>	13	25	35	50	75	90	90	110
Running Current	A	3,6	5,4	7,7	11,1	15,9	19,5	7,35	8,3
Power Supply	V/Ph/Hz	220-240/ 1/50	220-240/ 1/50	220-240/ 1/50	220-240/ 1/50	220-240/ 1/50	220-240/ 1/50	380/3/50	380/3/50
Compressor Quantity		1	1	1	1	1	1	1	1
Compressor		rotary	rotary	rotary	rotary	scroll	scroll	scroll	scroll
Refrigerant		R407C	R407C	R407C	R407C	R407C	R407C	R407C	R407C
Quantity	Kg	0,4	0,6	0,8	1,1	1,3	1,8	1,8	2,2
Low pressure	MPa	1,4	1,4	1,4	1,4	1,4	1,4	1,4	1,4
High pressure	MPa	3,1	3,1	3,1	3,1	3,1	3,1	3,1	3,1
Pressure meter		No	No	Yes	Yes	Yes	Yes	Yes	Yes
Fan quantity		1	1	1	1	1	1	1	1
Fan Power Input	W	50	50	120	120	120	200	200	200
Fan Speed	RPM	870	870	850	850	850	830	830	830
Air flow	m <sup>3</sup> /h	1500	1800	2100	2300	3200	5000	5000	6000
Fan Direction		horizon -tal	horizon -tal	horizon -tal	horizon -tal	horizon -tal	vertical	vertical	vertical
Noise	dB (A)	47	47	51	54	54	58	58	58
Water Connection	mm	32	32	50	50	50	50	50	50
Nominal Water Flow	m <sup>3</sup> /h	1,5	2,2	3,0	4,5	6,0	7,5	7,5	9,0
Water Pressure Drop (max)	kPa	6	8	10	10	10	12	12	12
Unit Net Dimensions (L/W/H)	mm	770/350/ 540	770/350/ 540	1005/370 /615	1005/370 /615	1115/470 /850	720/660/ 880	720/660/ 880	720/660/ 880
Unit Shipping Dimensions (L/W/H)	mm	910/330/ 595	910/330/ 595	1070/405 /650	1070/405 /650	1200/480 /900	760/700/ 890	760/700/ 890	760/700/ 890
Net Weight / Shipping Weight	kg	30/33	41/48	60/67	66/73	95/105	125/135	125/135	135/145

**Measurement conditions:** Outdoor air temp: 25 °C , Inlet water temp: 25 °C

# 2. SPECIFICATIONS

---

## 2.2 Dimensions for Swimming Pool Heat Pump Unit

**Unit Model**  
DURA-3/6/8/12/17

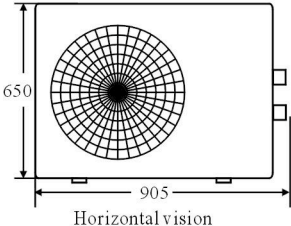
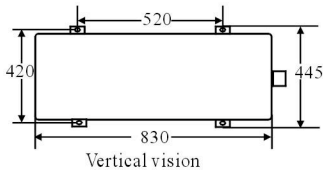

**Unit Model**  
DURA-21/21T/25T

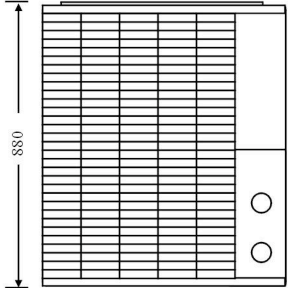
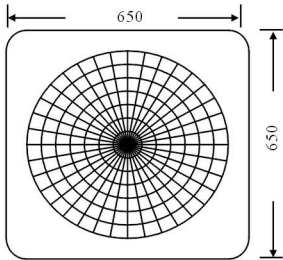

## 3. INSTALLATION AND CONNECTION

---

### 3.1 Installation of system

#### Installing Heat Pump & Chlorinator Pressure-type Chlorinator or Brominator

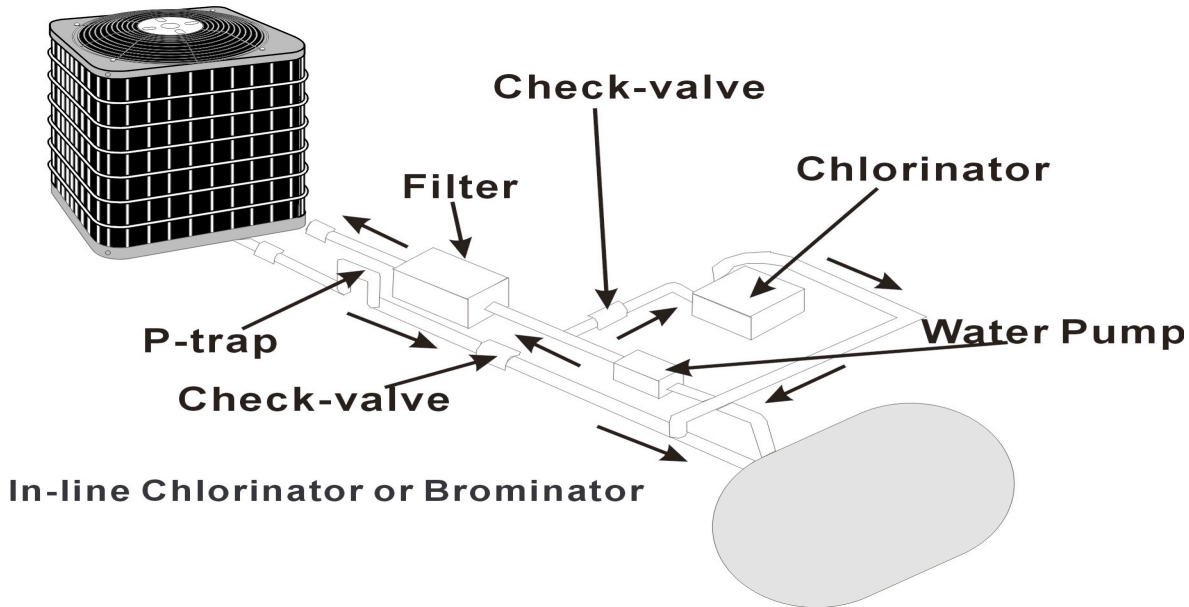

#### In-line Chlorinator or Brominator

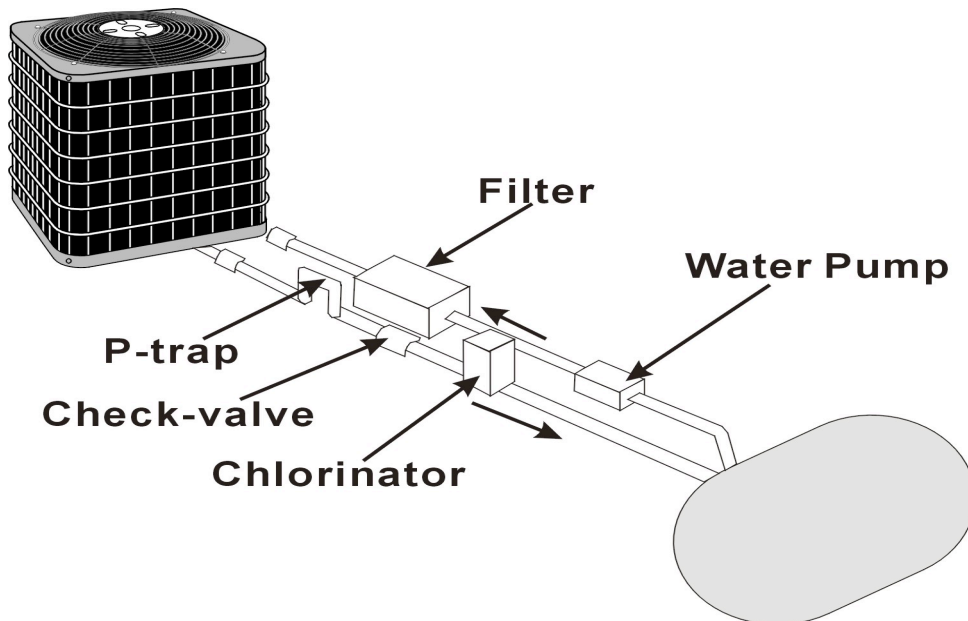

#### Installation items:

The factory only provides the heat pump unit; the other items including an eventual bypass, in the illustration are necessary parts for the water system, provided by users or the installer.

#### Attention:

Please follow these steps when installing the heat pump:

1. All feeding of chemicals to the pool water has to be done downstream of the heat pump.
2. Install a bypass when the flow of the pool pump is more than 30% above the rated flow of the heat exchanger of the heat pump.
3. Install the heat pump above the level of the pool water.

## 3. INSTALLATION AND CONNECTION

---

### 3.2 Swimming Pool Heat Pumps Location

The unit will perform well in any outdoor location provided three factors are present:

1. Fresh Air
2. Electricity
3. Pool filter piping

The unit may be installed virtually anywhere outdoors. For Indoor Pools please consult the supplier. Unlike a gas heater it has no draft or pilot light problem in a windy area.

**DO NOT** place the unit in an enclosed area with a limited air volume where the unit discharge air will be re-circulated.

**DO NOT** place the unit to shrubs which can block the air inlet. These locations deny the unit of a continuous source of fresh air which reduces its efficiency and may prevent adequate heat delivery.

The picture below give the minimum required distances from each side of the heat pump.

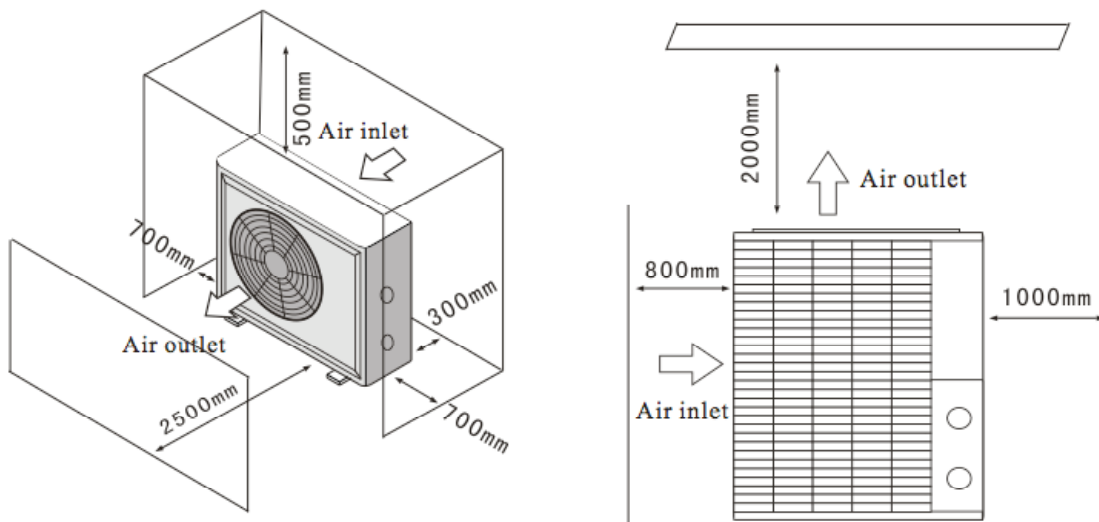

### 3.3 How Close To Your Pool?

Normally, the pool heat pump is installed within 7.5 meters of the pool. The longer the distance from the pool, the greater the heat loss from the piping. For the most part the piping is buried. Therefore the heat loss is minimal for runs of up to 30 meters (15 meters to and from the pump = 30 meters total), unless the ground is wet or the water table is high. A very rough estimate of heat loss per 30 m is 0.6 kW-hour, (2000BTU) for every 5 °C difference in temperature between the pool water and ground surrounding the pipe, which translates to about 3% to 5% increase in run time.

## 3. INSTALLATION AND CONNECTION

---

### 3.4 Swimming Pool Heat Pumps Plumbing

The Swimming Pool Heat Pumps exclusive full flow DURANIUM® heat exchanger requires no special plumbing arrangements or bypass up to flows of 11 m<sup>3</sup>/h. The water pressure drop is less than 10kPa at max. A bypass is necessary when the flow of the pool pump is above 11 m<sup>3</sup>/h through the heat exchanger.

Since there is no residual heat, the unit can be connected with normal PVC to the filtering circuit.

Location: Connect the unit in the pool pump discharge (return) line downstream of all filter and pool pumps, and upstream of any chlorinators, ozonators or chemical pumps.

Standard models have slip glue fittings which accept 32mm or 50mm PVC pipe for connection to the pool or spa filtration piping. By using 50NB to 40NB you can plump 40NB PVC piping straight into the unit.

Give serious consideration to adding a quick coupler fitting at the unit inlet and outlet to allow easy draining of unit for winterizing and to provide easier access should servicing be required.

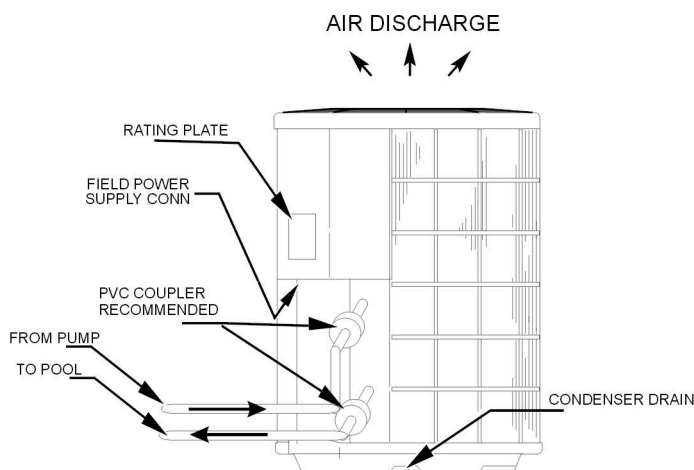

Condensation: Since the Heat pump cools down the air about 4 - 5 °C, water may condense on the fins of the horseshoe shaped evaporator. If the relative humidity is very high, this could be as much as several gallons an hour. The water will run down the fins into the basepan and drain out through the barbed plastic condensation drain fitting on the side of the basepan. This fitting is designed to accept 20mm clear vinyl tubing which can be pushed on by hand and run to a suitable drain. Many people have mistaken the condensation for a water leak inside the unit.

**NOTE: A quick way to verify that the water running through the drain is condensation is to shut off the unit and keep the pool pump running. If the water stops running out of the base pan, it is condensation. AN EVEN QUICKER WAY - TEST THE DRAIN WATER FOR CHLORINE - if there is no chlorine present, then it's condensation.**



## 3. INSTALLATION AND CONNECTION

---

### 3.5 Swimming Pool Heat Pumps Electrical Wiring

**NOTE: Although the unit heat exchanger is electrically isolated from the rest of the unit, it simply prevents the flow of electricity to or from the pool water. Grounding the unit is still required to protect you against short circuits inside the unit. Bonding is also required**

The unit has a separate molded -in junction box with a standard electrical conduit nipple already in place. Just remove four screws and the front panel, feed your supply lines in through the conduit nipple and wire-nut the electric supply wires to the three connections already in the junction box. (four connections if three phase) To complete electrical hookup connect Heat pump by electrical conduit, UF cable or other suitable means of the proper size wire (as permitted by local electrical codes) to a dedicated AC power supply branch circuit equipped with the proper circuit breaker, disconnect or time delay fuse protection.

If you want the filter pump or a separate water pump controlled by the heat pump, just feed the supply lines of the water pump in the unit and connect it to the connections (labeled 'PUMP'). For a three-phase pump an extra relay will be necessary.

**Disconnect** - A disconnect means (circuit breaker, fused or unfused switch) should be located within sight of and readily accessible from the unit, this is common practice on commercial and residential air conditioners and heat pumps. It prevents remotely energizing unattended equipment and permits turning off power at the unit while the unit is being serviced.

### 3.6 Initial startup of the Unit

**NOTE- In order for the unit to heat the pool or spa, the filter pump must be running to circulate water through the heat exchanger.**

Start up Procedure - after the installation is completed, you should follow these steps:

1. Turn on your filter pump. Check for water leaks and verify flow to and from the pool.
2. Turn on the electrical power supply to the unit, then press the key ON/OFF on the wire controller: it should start in several seconds.
3. After running a few minutes make sure the air leaving the top(side) of the unit is cooler (Between 5 - 10°C)
4. With the unit operating turn the filter pump off. The unit should also turn off automatically, if not, readjustment of flow switch is required.
5. Allow the unit and pool pump to run 24 hours per day until desired pool water temperature is reached. When the set temperature is reached, the unit just shuts off. The unit will now automatically restart (as long as your pool pump is running) when the pool temperature drops more than 1 degree Celsius below set temperature.

**Water Flow Switch** - the unit is equipped with a flow switch that turns it on when the pool pump is running and shuts it off when the pump shuts off. This switch is the same type used in all gas pool heaters and is factory adjusted for normal pool installations. If the pool water level is more than one meter above or below the thermostat knob of the unit, your dealer may need to adjust it at initial startup.

**Time Delay** - the unit is equipped with a 3 minute built-in solid state restart delay included to protect control circuit components and to eliminate restart cycling and contactor chatter. This time delay will automatically restart the unit approximately 3 minutes after each control circuit interruption. Even a brief power interruption will activate the solid state 3 minute restart delay and prevent the unit from starting until the 3 minute countdown is completed. Power interruptions during the delay period will have no effect on the 3 minute countdown.

# 4. USAGE AND OPERATION

## 4.1 The Functions of the LED Controller

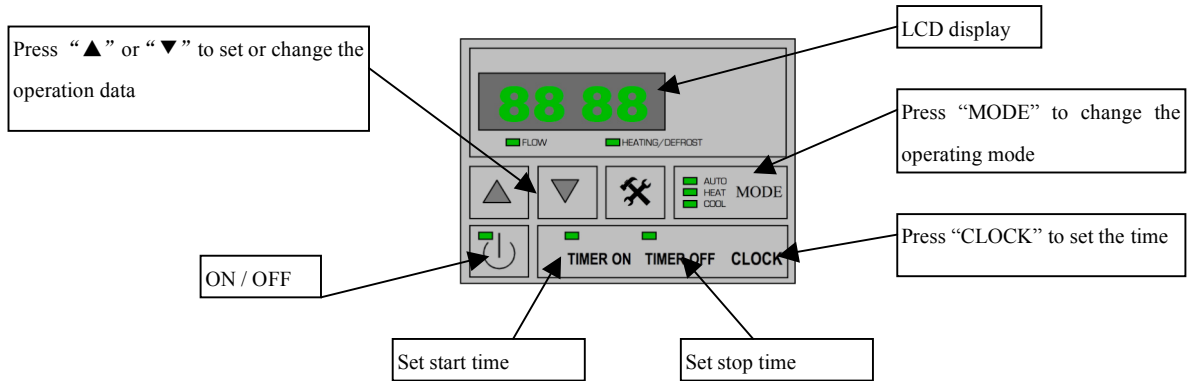

## 4.2 How to set the parameters (only when system has stopped, “OFF” on display)

- Press “✖” to access the parameters. Press “▲” or “▼” to select one.
- Press “MODE” & “⏻” at the same time to start setting parameters from 0-9 (see parameter table).
- Press “▲” or “▼” to select data for parameters from 0-9
- Stop pressing for 5 seconds and the LED screen will revert to its previous display.
- Pressing “▲” or “▼” without pressing “✖” first, will change the desired temperature.

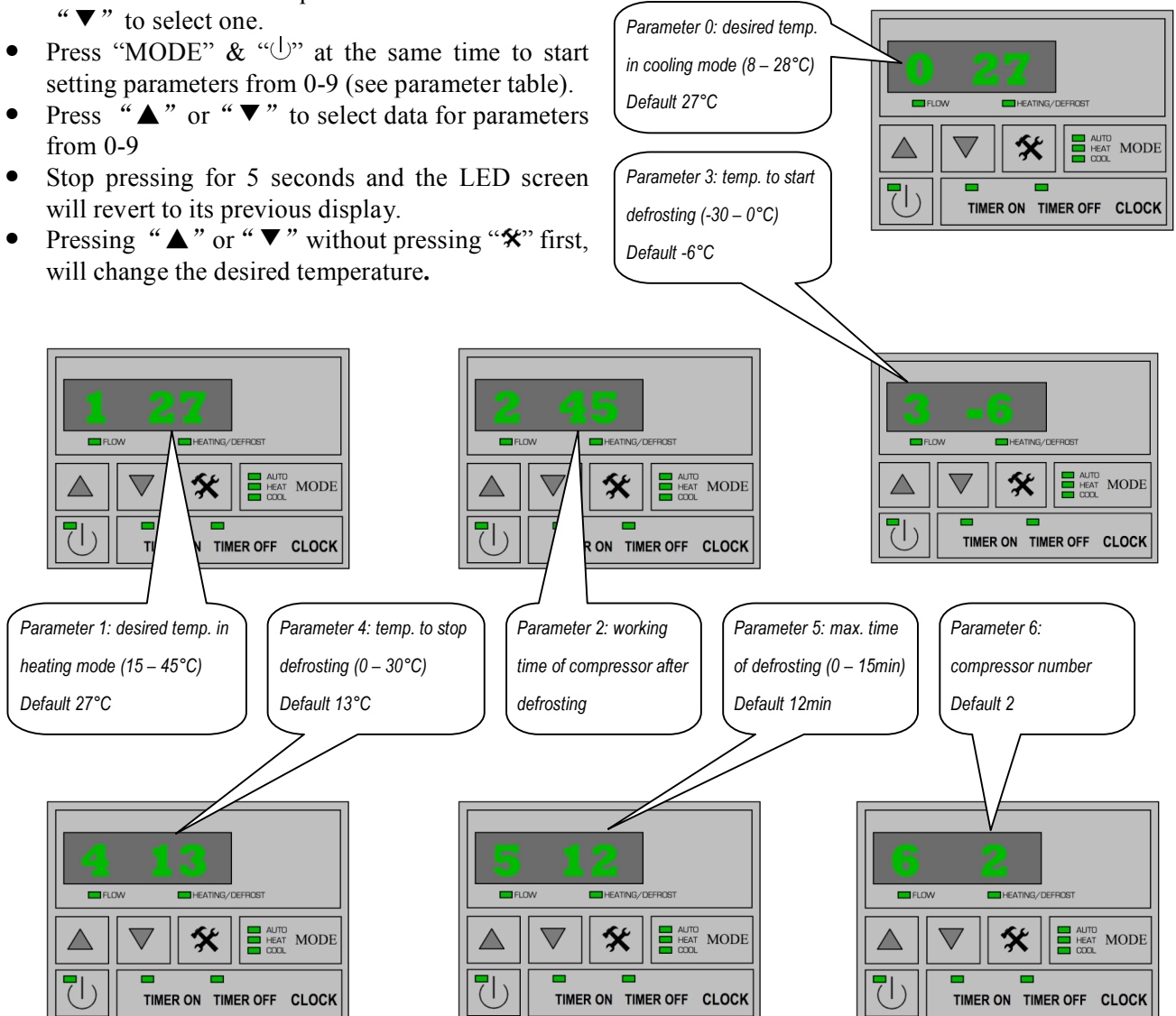

## 4. USAGE AND OPERATION

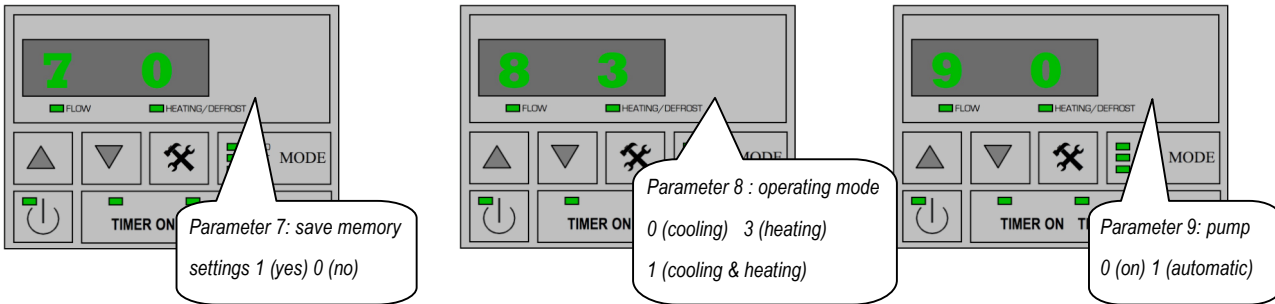

### 4.3 How to choose Mode

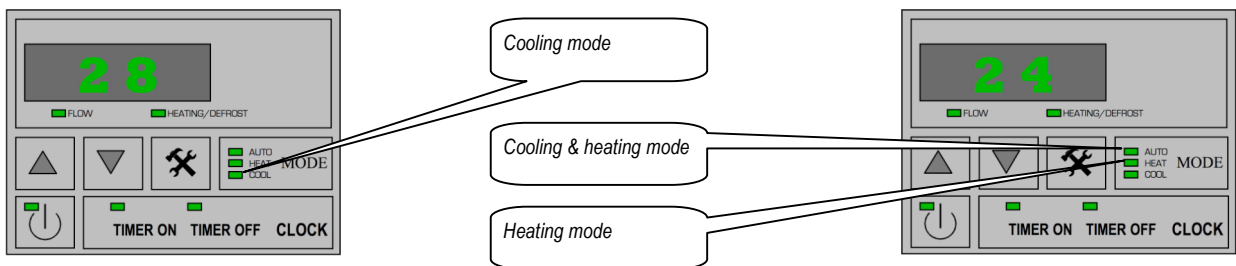

- Press “MODE” to choose mode at first; (mode can only be changed when parameter 8 is set to ‘1’)
- Press “⏻” to switch on the unit, the LED displays the water-in temperature;
- Please note that the mode can also be changed when the unit is running.

### 4.4 How to know the current status?



## 4. USAGE AND OPERATION

---

Press “✱” to check the current status of the unit.

You can see the water-in/ water-out/ condensor1/ condensor2/ ambient temperature as A, b, C, d, E by pressing “▲” or “▼”.

If no buttons are pressed within 5 seconds, the LED displays the water-in temperature;

When the unit is switched off (in ‘Standby’), “OFF” is displayed.

### 4.5 CLOCK setup

Press the “CLOCK” key to change the clock and press “▲” or “▼” to adjust the time. Press “CLOCK” again to save the new settings.

The keys “TIMER ON” and “TIMER OFF” can’t be used during the setting of the clock.

### 4.6 TIMER ON setup

The key “TIMER ON” is used to set the time to start the unit. Pressing it once, starts the timer. When the key is pressed a second time, the time can be changed by pressing “▲” or “▼”. When the LED display is showing the correct time, the value is stored by pressing “TIMER ON” again. The timer can always be cancelled by pressing the “CLOCK” key.

### 4.7 TIMER OFF setup

The key “TIMER OFF” is used to set the time to stop the unit. Pressing it once, starts the timer. When the key is pressed a second time, the time can be changed by pressing “▲” or “▼”. When the LED display is showing the correct time, the value is stored by pressing “TIMER OFF” again. The timer can always be cancelled by pressing the “CLOCK” key.

## 4.8 Operation data setting

### INSTALLER PLEASE NOTE:

The units operation parameters MUST be checked and set after installation and before the customer uses it. It maybe a little complex when you set them for the first time, but once it is done, it will provide the customer with good and easy enjoyment.

**REMARK:** With the  $\odot$  button , the unit is toggled between on (running) or off (standby).

While ‘on’ (running) the display shows the inlet water temperature.

While ‘off’ (standby) the display shows “OFF”.

Parameters can only be changed when the unit is ‘off’ (in standby).

The ‘cooling’ mode can only be selected after the parameter 8 is set to 1 (heat & cool) or to 0 (cooling only)

The units’ operation data can be set with the controller.

### System parameter table

Data	Signification	Range	Default	Remark
0	Inlet water temperature setting under cooling mode	8-28℃	27℃	Adjustable
1	Inlet water temperature setting under heating mode	15-40℃	27℃	Adjustable
2	When heating, defrost period	30-90min	45min	Adjustable
3	Temperature condition for enter defrosting (under heating mode)	-30-0℃	-7℃	Adjustable
4	Temperature condition for exit defrosting (under heating mode)	0-30℃	13℃	Adjustable
5	Time condition for exit defrosting (under heating mode)	0-15min	8min	Adjustable
6	System number	1/2	2	Adjustable
7	With /without memory functions	0/1	1 (memory)	Adjustable
8	mode (cooling only/ heat & cool / auxiliary electrical heating/ heating only )	0/1/2/3	3 (heat pump)	Adjustable
9*	Water pump	0/1	1	Adjustable
A	Inlet water temperature	-9~90℃		True test value
B	Outlet water temperature	-9~90℃		True test value
C	Condensor 1 temperature	-9~90℃		True test value
D	Condensor 2 temperature	-9~90℃		True test value
E	Ambient temperature	-9~90℃		True test value

Notice: Above data setting 0 is relevant to cooling mode only. All other data (ie 1 – 9) are relevant to heating.

\* remark: paramater 9: 0 (always open)

1 (starts 10 sec before compressor starts,  
stops 30 sec after compressor stops)

The filterpump or a waterpump for pumping water through the unit can be connected to the controller. (The connections for single faze pumps are labeled ‘PUMP’) The water pump will then be controlled by the heatpump controller when parameter 9 is set to 1.

## 5. MAINTENANCE AND INSPECTION

---

### 5.1 Maintenance

- Check the water supply device and the release often. Low water flow and air entering into the system should be avoided, as this will diminish the units' performance and reliability. You should clean the pool/spa filter regularly to avoid damage to the unit as a result of the dirty or clogged filter.
- The area around the unit should be dry, clean and well ventilated. Clean the side heating exchanger regularly to maintain good heat exchange and to save energy.
- The operation pressure of the refrigerant system should only be serviced by a certified technician.
- Check the power supply and cable connection often. Should the unit begin to operate abnormally, switch it off and contact a qualified technician.
- In winter, please discharge all water from the water pump and other systems to prevent damage from freezing.
- You should discharge the water at the bottom of the water pump if the unit will not work for an extended period of time. You should check the unit thoroughly and fill the system with water fully before using it for the first time after a prolonged period of no usage.

### 5.2 Trouble shooting guide

Improper installation will create an electrical hazard, which could result in death or serious injury to pool users, installers, or others due to electrical shock, and may also cause damage to property.

**DO NOT** attempt any internal adjustments inside the heater.

1. Keep your hands and hair clear of the fan blades to avoid injury.
2. If you are not familiar with your pool filtering system and heater:
  - a. **Do not** attempt to adjust or service without consulting your dealer, professional pool or air conditioning contractor.
  - b. Read the entire installation and users guide before attempting to use, service or adjust the heater or pool filtering system.

**Note:** Turn off power to the unit prior to attempt service or repair.