

IntelliFlo® VF

Variable Flow Pump

(Compatible with IntelliTouch® control system and IntelliComm® communication center)



Installation and User's Guide



IMPORTANT SAFETY INSTRUCTIONS
READ AND FOLLOW ALL INSTRUCTIONS
SAVE THESE INSTRUCTIONS

Technical Support

Sanford, North Carolina (8 A.M. to 5 P.M. ET)

Moorpark, California (8 A.M. to 5 P.M. PT)

Phone: (800) 831-7133

Fax: (800) 284-4151

Web sites: www.pentairpool.com and www.staritepool.com

Protected by U.S. Patents Pending

© 2009 Pentair Water Pool and Spa, Inc. All rights reserved

This document is subject to change without notice.

1620 Hawkins Ave., Sanford, NC 27330 • (919) 566-8000
10951 West Los Angeles Ave., Moorpark, CA 93021 • (805) 553-5000

Trademarks and disclaimers: IntelliFlo®, IntelliTouch®, EasyTouch®, SunTouch®, IntelliComm® and Pentair Water Pool and Spa® are trademarks and/or registered trademarks of Pentair Water Pool and Spa, Inc. and/or its affiliated companies in the United States and/or other countries. Teflon® is a registered trademark of E.I. Du Pont De Nemours and Company Corporation. Unless noted, names and brands of others that may be used in this document are not used to indicate an affiliation or endorsement between the proprietors of these names and brands and Pentair Water Pool and Spa, Inc. Those names and brands may be the trademarks or registered trademarks of those parties or others.

P/N 350075 Rev D - 7-14-09

Contents

Important Safety Precautions	iii
Section 1: Introduction	1
IntelliFlo Overview	1
IntelliFlo Features	2
IntelliFlo Motor Assembly	2
IntelliFlo Motor Features	3
IntelliFlo Drive Assembly and Control Panel	4
Operator Control Panel Features	4
Section 2: Operator Control Panel	5
IntelliFlo Operator Control Panel	5
Controls and LEDs	5
Navigating the Menu Structure	7
Section 3: Operating IntelliFlo	9
Metering the System	9
Manual Mode	9
IntelliFlo Control Panel Menu	11
Menu Structure	12
Pool Data Mode	13
Priming Mode	14
Priming Menu	14
Filter Mode	16
Filter Menu	16
Programming Cycles Per Day	17
Filter Cycle Settings	18
Clean Filter Pressure Example	19
Alert Status	19
Using Filter mode with Features mode	20
Filter Mode and Flow Control	21
Flow Control and Filter Mode	21
Time and Contrast Menu	22
Setting System Time	22
Setting the LCD Backlight Contrast	22
Features Mode	23
Features 1 & 2	23
Features 3 -9	23
M. O. Flo	23
Feature Settings	24
How to set up the Feature 1 or 2 (Flow and Duration) mode	25
Features 1 – 2 (Flow and Duration)	26
To run Feature 1 or 2 (Flow and Duration)	26
Features 3 – 9 (Flow, Start/Stop Time)	26
Enabling Features 3 – 9	26
Mo Flo (Modulation Output flow)	28

Contents (Continued)

External Control with IntelliComm Communication Center	29
Setting up External Control using IntelliComm	30
Controlling IntelliFlo with IntelliTouch	31
Connecting IntelliFlo to IntelliTouch	33
Backwash Mode	33
Backwash menu	33
Running Backwash mode	34
Backwash menu screens	34
Vacuum Mode	35
Vacuum menu	35
Section 4: Maintenance	37
Pump Strainer Basket Service	37
Motor Service	38
Winterizing	39
Manual Priming and Initial Start-up After Service	39
Section 5: Installation and Removal	41
Installing the IntelliFlo	41
Location	41
Piping	41
Check Valves	41
Wiring the IntelliFlo	42
Pump Disassembly	43
Pump Reassembly/Seal Replacement	44
Shaft Seal Replacement	44
Drive Assembly Removal and Installation	45
Illustrated Parts List	46
Replacement Parts	46
IntelliFlo Pump Dimensions	47
IntelliFlo Flow and Power vs Flow Pump Curve	47
IntelliFlo Electrical Specifications	47
Section 5: Troubleshooting	49
Alerts and Warnings	49
Suction Blockage	49
General IntelliFlo Troubleshooting Problems	50
General Warnings	52
Electrical Cost Overview	52
How to make your pool more energy efficient	53
Using your IntelliFlo pump	53
Automatic pool sweeps (booster pump style)	53
Filter during off-peak times	53
Setting filtering time	53
Preventive maintenance	54
Energy Efficient IntelliFlo pump	54

IMPORTANT SAFETY PRECAUTIONS

⚠ DANGER

SERIOUS BODILY INJURY OR DEATH CAN RESULT IF THIS PUMP AND SAND FILTER IS NOT INSTALLED AND USED CORRECTLY.

⚠ DANGER

INSTALLERS, POOL OPERATORS AND POOL OWNERS MUST READ THESE WARNINGS AND ALL INSTRUCTIONS BEFORE USING THIS PUMP AND SAND FILTER.

⚠ WARNING

This pump is intended for use in swimming pool applications.

⚠ WARNING

Most states and local codes regulate the construction, installation, and operation of public pools and spas, and the construction of residential pools and spas. It is important to comply with these codes, many of which directly regulate the installation and use of this product. Consult your local building and health codes for more information.



IMPORTANT NOTICE - Attention Installer: This Installation and User's Guide ("Guide") contains important information about the installation, operation and safe use of this pump. This Guide should be given to the owner and/or operator of this equipment.

Before installing this product, read and follow all warning notices and instructions in this Guide. Failure to follow warnings and instructions can result in severe injury, death, or property damage. Call (800) 831-7133 for additional free copies of these instructions. Please refer to www.pentair.com for more information related to these products.

⚠ DANGER

SUCTION ENTRAPMENT HAZARD

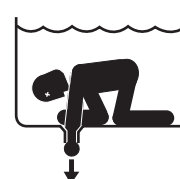
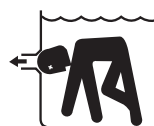

Pool and spa pumps move large volumes of water, which can pose extreme danger if a person's hair comes in close proximity to a drain that is not the proper size for the pump or pumps.

Hair Entanglement – When the hair tangles or knots in the drain cover, trapping the swimmer underwater. This hazard is present when the flow rating of the cover is too small for the pump or pumps.

Limb Entrapment – When a limb is sucked or inserted into an opening resulting in a mechanical bind or swelling. This hazard is present when a drain cover is missing, broken, loose, cracked or not properly secured.

Body Entrapment – When a portion of the body is held against the drain cover trapping the swimmer underwater. This hazard is present when the drain cover is missing, broken or the cover flow rating is not high enough for the pump or pumps.

Evisceration/Disembowelment – When a person sits on an open pool (particularly a child wading pool) or spa outlet and suction is applied directly to the intestines, causing severe intestinal damage. This hazard is present when the drain cover is missing, loose, cracked, or not properly secured.

Mechanical Entrapment – When jewelry, swimsuit, hair decorations, finger, toe or knuckle is caught in an opening of an outlet or drain cover. This hazard is present when the drain cover is missing, broken, loose, cracked, or not properly secured.

⚠ DANGER



RISK OF ELECTRICAL SHOCK OR ELECTROCUTION:

PUMPS REQUIRE HIGH VOLTAGE WHICH CAN SHOCK, BURN, OR CAUSE DEATH. BEFORE WORKING ON PUMP!

Always disconnect power to the pool pump at the circuit breaker from the pump before servicing the pump. Failure to do so could result in death or serious injury to service person, pool users or others due to electric shock.

IMPORTANT SAFETY PRECAUTIONS (continued)



Water temperature in excess of 100° F (37.7° C) may be hazardous to your health. Prolonged immersion in hot water may induce hyperthermia. Hyperthermia occurs when the internal temperature of the body reaches a level several degrees above normal body temperature of 98.6° F (37° C.). Effects of hyperthermia include: (1) Unawareness of impending danger. (2) Failure to perceive heat. (3) Failure to recognize the need to leave the spa. (4) Physical inability to exit the spa. (5) Fetal damage in pregnant women. (6) Unconsciousness resulting in danger of drowning. The use of alcohol, drugs, or medication can greatly increase the risk of fatal hyperthermia in hot tubs and spas.



When setting up pool water turnovers or flow rates the operator must consider local codes governing turnover as well as disinfectant feed ratios.



DO NOT increase pump size; this may increase the flow rate through the system and exceed the maximum flow rate stated on the drain cover.



Do not permit children to operate this product.



If this pump is intended for use other than single-family dwellings, a clearly labeled emergency switch shall be provided as part of the installation. The switch shall be readily accessible to the occupants and shall be installed at least 5 feet (1.52 m) away, adjacent to, and within sight of, the unit.



When setting up pool water turnovers or flow rates the operator must consider local codes governing turnover as well as disinfectant feed ratios.



Before servicing the system, switch the main power OFF and remove the communication cable from the pump.



Install the pump a minimum of five (5) feet from the inside wall of the pool and spa. Canadian installations require a minimum of three (3) meters from pool water.



A No. 8 AWG (No. 6 AWG in Canada) or larger conductor must be wired to the motor bonding lug.



This pump is for use with permanently installed pools and may also be used with hot tubs and spas if so marked. Do not use with storable pools. A permanently installed pool is constructed in or on the ground or in a building such that it cannot be readily disassembled for storage. A storable pool is constructed so that it may be readily disassembled for storage and reassembled to its original integrity and has a maximum dimension of 18 feet (5.49m) and a maximum wall height of 42 inches (1.07m).



For hot tubs and spa pumps, do not install within an outer enclosure or beneath the skirt of a hot tub or spa unless so marked.



The IntelliPro pump is capable of generating systems pressures up to 50 psi. Installers must ensure that all system components are rated to withstand at least 50 psi. Over pressurizing the system can result in catastrophic component failure or property damage.



Never exceed the maximum stated pump flow rating.

Only use a pumping system rated for the corresponding flow. FAILURE TO DO SO CAN RESULT IN HAIR OR BODY ENTRAPMENT WHICH CAN CAUSE SERIOUS PERSONAL INJURY OR DEATH. If in doubt about the rating of your system, consult a qualified pool service professional.



Pumps are not a substitute for properly installed and secured pool drain covers. An ANSI/ASME A112.19.8 approved anti-entrapment drain cover must be used for each drain. Pools and spas should utilize a minimum of two drains per pump. Regularly inspect all covers for cracks, damage and advanced weathering. If a cover becomes loose, cracked, damaged, broken or is missing, close the pool or spa immediately, shut off the pump, post a notice and keep the pool or spa closed until an appropriate VGB 2008 certified cover is properly installed. Covers deteriorate over time due to exposure to sunlight and pool chemicals. This cover must be replaced within seven (7) years from installation (or earlier if the cover becomes damaged in any way).

IMPORTANT SAFETY PRECAUTIONS (continued)

⚠ WARNING



Entrapment Avoidance Notice:

The suction outlet connected to a swimming pool or spa pump can pull a high vacuum if it is blocked. Therefore, if only one suction outlet smaller than 18" x 23" is used, anyone blocking the suction outlet with their body can be trapped and held against the suction outlet. Disembowelment or drowning can result. Therefore, if small suction outlets are used with this pump, to prevent this entrapment and possible death, install at least two suction outlets in the body of water. Separate these suction outlets as described in the International Residential Code (IRC), the International Business Code (IBC), the Consumer Products Safety Council (CPSC) Guidelines for Entrapment Hazards: Making Pools and Spas Safer or ANSI/IAF-7 Standard for Suction Entrapment Avoidance in Swimming Pools, Wading Pools, Spas, Hot Tubs and Catch Basins. If suction outlets are not used, additional entrapment avoidance measures as described in the CPSC Guidelines or ANSI/IAF-7 should be employed.

The covers used on suction outlets should be approved and listed as conforming to the currently published edition of ANSI/ASME A112.19.8 Standard covering Suction Fittings for Use in Swimming Pools, Wading Pools, Spas and Hot Tubs. These covers should be inspected regularly and replaced if cracked, broken or older than the design lifetime indicated on them by the manufacturer. The maximum possible flow rate of this pump should be less than or equal to the maximum approved flow rate indicated on the suction outlet cover by the manufacturer. **THE USE OF UNAPPROVED COVERS OR ALLOWING USE OF THE POOL OR SPA WHEN COVERS ARE CRACKED OR BROKEN CAN RESULT IN HAIR ENTANGLEMENT WHICH CAN RESULT IN DEATH.**

The Virginia Graeme Baker Pool and Spa Safety Act imposes certain new requirements on owners and operators of swimming pools and spas.

Pools or spas constructed on or after December 20, 2008, shall utilize:

- (A) No submerged suction outlets, a gravity drainage system with ASME/ANSI cover(s), one or more unblockable outlets; or
- (B) A multiple main drain system without isolation capability with suction outlet covers that meet ASME/ANSI A112.19.8 Suction Fittings for Use in Swimming Pools, Wading Pools, Spas, and Hot Tubs and either:
 - (i) A safety vacuum release system (SVRS) meeting ASME/ANSI A112.19.17 Manufactured Safety Vacuum Release Systems (SVRS) for Residential and Commercial Swimming Pool, Spa, Hot Tub, and Wading Pool Suction Systems and/or ASTM F2387 Standard Specification for Manufactured Safety Vacuum Release Systems (SVRS) for Swimming Pools, Spas and Hot Tubs or
 - (ii) A properly designed and tested suction-limiting vent system or
 - (iii) An automatic pump shut-off system.

Pools and spas construction prior to December 20, 2008, with a single submerged suction outlet shall use a suction outlet cover that meets ASME/ANSI A112.19.8 and either:

- (A) A multiple main drain system without isolation capability, or
- (B) A safety vacuum release system (SVRS) meeting ASME/ANSI A112.19.17 and/or ASTM F2387, or
- (C) A properly designed and tested suction-limiting vent system, or
- (D) An automatic pump shut-off system, or
- (E) Disabled submerged outlets, or
- (F) Suction outlets shall be reconfigured into return inlets.

For information about the Virginia Graeme Baker Pool and Spa Safety Act, contact the Consumer Product Safety Commission at (301) 504-7908 or visit www.cpsc.gov.

NOTE: Always turn off all power to the pool pump before installing the cover or working on any suction outlet.

IMPORTANT SAFETY PRECAUTIONS (continued)

General Installation Information

- All work must be performed by a qualified pool professional, and must conform to all national, state, and local codes.
- Install to provide drainage of compartment for electrical components.

General Installation Information

WARNING

Pumps improperly sized or installed or used in applications other than for which the pump was intended can result in severe personal injury or death. These risks may include but not be limited to electric shock, fire, flooding, suction entrapment or severe injury or property damage caused by a structural failure of the pump or other system component.

WARNING

The pump can produce high levels of suction within the suction side of the plumbing system. These high levels of suction can pose a risk if a person comes within the close proximity of the suction openings. A person can be seriously injured by this high level of vacuum or may become trapped and drown. It is absolutely critical that the suction plumbing be installed in accordance with the latest national and local codes for swimming pools.

- These instructions contain information for a variety of pump models and therefore some instructions may not apply to a specific model. All models are intended for use in swimming pool applications. The pump will function correctly only if it is properly sized to the specific application and properly installed.

General Warnings

- Never open the inside of the drive motor enclosure. There is a capacitor bank that holds a 230 VAC charge even when there is no power to the unit.
- The IntelliPro VS-3050 pump is not submersible
- The IntelliPro VS-3050 pump is capable of 174 GPM or 104 feet of head; use caution when installing and programming to limit pumps performance potential with old or questionable equipment
- Code requirements for the electrical connection differ from state to state. Install equipment in accordance with the National Electrical Code and all applicable local codes and ordinances.
- Always Press the Stop button and disconnect the communication cable before performing maintenance, and always power the unit off by disconnecting the main circuit to the pump

Two Speed Pump Controls Notice (Title 20 Compliance)

Please read the following important Safety Instructions. When using two-speed pumps manufactured on or after January 1, 2008, the pump's default circulation speed MUST be set to the LOWEST SPEED, with a high speed override capability being for a temporary period not to exceed one normal cycle, or two hours, whichever is less.

Section 1

Introduction

IntelliFlo® VF Overview

The IntelliFlo VF variable-flow pump control system offers pool and spa filter automation and advanced features that include energy conservation and programmable scheduled water features for your pool, spa, cleaner, waterfall, and other applications.

The IntelliFlo pump can adapt to any application up to 130 gallons per minute, you simply program IntelliFlo to suit the application. IntelliFlo then dials in the perfect operating conditions for that specific flow rate.

IntelliFlo can reduce energy cost by as much as 90% based on a pool size up to 15,000 gallons, one turn per day with a 24 hour cycle.

IntelliFlo constantly monitors water flow and electrical current to ensure that the filtration system is operating at peak efficiency. This can result in maximum energy efficiency savings never before possible – up to 90% over conventional single speed and two speed pumps. The system protects against loss of prime or impedance of flow, under and over voltage situations, and thermal overload or freezing.

With IntelliFlo there's no need for pump curves and hydraulic calculations to determine the right pump for the job. Just set the program for your pool size and desired turnover, and IntelliFlo does the rest.

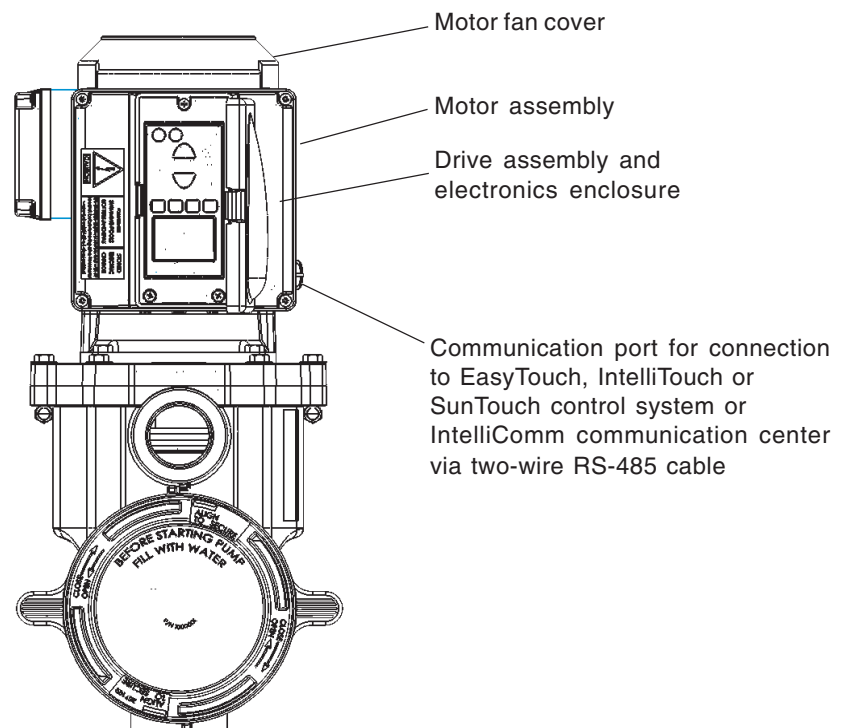

IntelliFlo VF (variable flow pump)

IntelliFlo Features

- Sizes itself to any pool
- Reduces energy cost by as much as 90%
- Protects against loss of prime or flow blockage
- Prevents thermal overload
- Detects and prevents damage from under and over voltage conditions
- Protects against freezing
- Can communicate with an IntelliTouch or IntelliComm system via a two-wire connection
- Easy to read operator control panel LCD display
- Operator control panel buttons for pump modes
- Built-in strainer pot and volute
- Ultra energy-efficient TEFC Square Flange Motor
- Compatibility with most cleaning systems, filters, and jet action spas
- 16-button LCD control panel
- Drive assembly features permanent magnet synchronous motor
- Heavy-duty, durable construction designed for long life
- Internal 24-hour clock for setting controlled on/off times for filtering and up to ten water features
- UL listed

IntelliFlo Motor Assembly

The IntelliFlo's three-phase, six-pole, permanent magnet motor operates at 3450 RPM (at 92% efficiency) and 400 RPM (at 90%). The motor assembly is continually cooled by an external fan. Dual seals on the motor shaft and at the fan assembly seal the entire motor from any moisture entering the motor assembly. For added protection, a slinger located in front of the main shaft seal assists in slinging water away from the shaft opening in the flange.

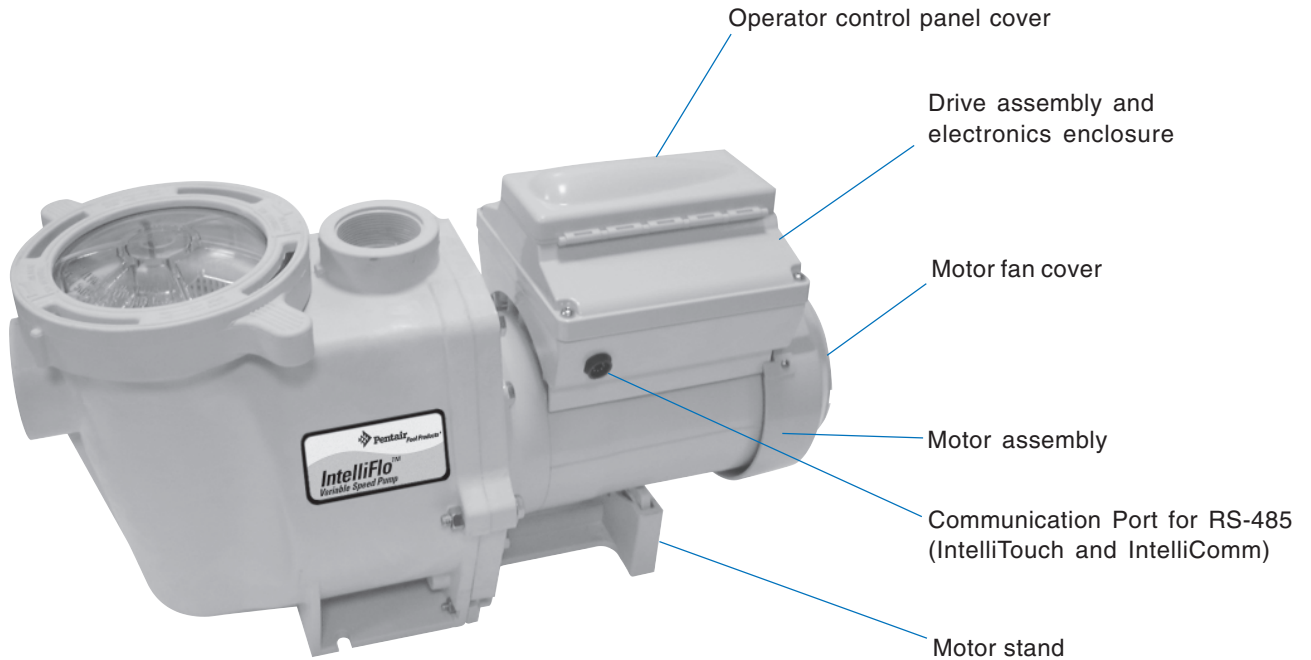

IntelliFlo VF Motor Assembly

IntelliFlo VF Motor Features

- Permanent Magnet Synchronous Motor (PMSM)
- High efficiency (3450 RPM 92% and 400 RPM 90%)
- Superior speed control
- Operates at lower temperatures due to high efficiency
- Same technology as deployed in hybrid electric vehicles
- Designed to withstand outdoor environment
- Totally Enclosed Fan Cooled
- Three-phase motor
- 56 Square Flange
- Six-Pole
- Low noise

IntelliFlo Drive Assembly and Control Panel

The IntelliFlo drive assembly consists of an operator control panel and the system electronics that drive the 230 VAC single phase (260 VAC~170 VAC) motor. The drive microprocessor controls the motor by changing the frequency of the current it receives together with changing the voltage to control the rotational speed.

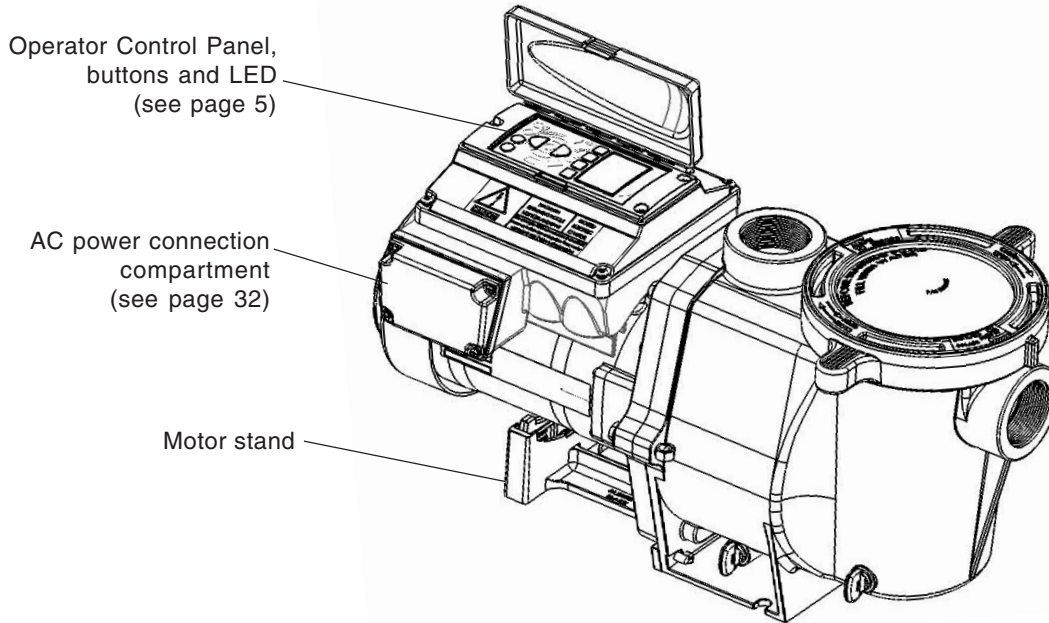

IntelliFlo Drive Assembly

Operator Control Panel Features

- **Backwash and Rinse** — Informs the user when and how to backwash filter media
- **Vacuum** — Can be preset using duration and flow parameters to save energy
- **Filter** — Allows pump to run at peak efficiency, saving users up to 90% in energy cost, based on a pool size up to 15,000 gallons, one turn per day with a 24 hour cycle
- **Feature** — Ten feature modes can be programmed to control filtration duration, start and stop time, and frequency for cleaners, water features, spas, and waterfalls
- **Manual** — Allows the user to override all programming and run the pump using RPM or flow (GPM) control parameters. All personnel safety devices and alarms do not operate in speed mode.

Section 2

Operator Control Panel

This section describes the operator control panel controls and LEDs.

IntelliFlo VF Operator Control Panel

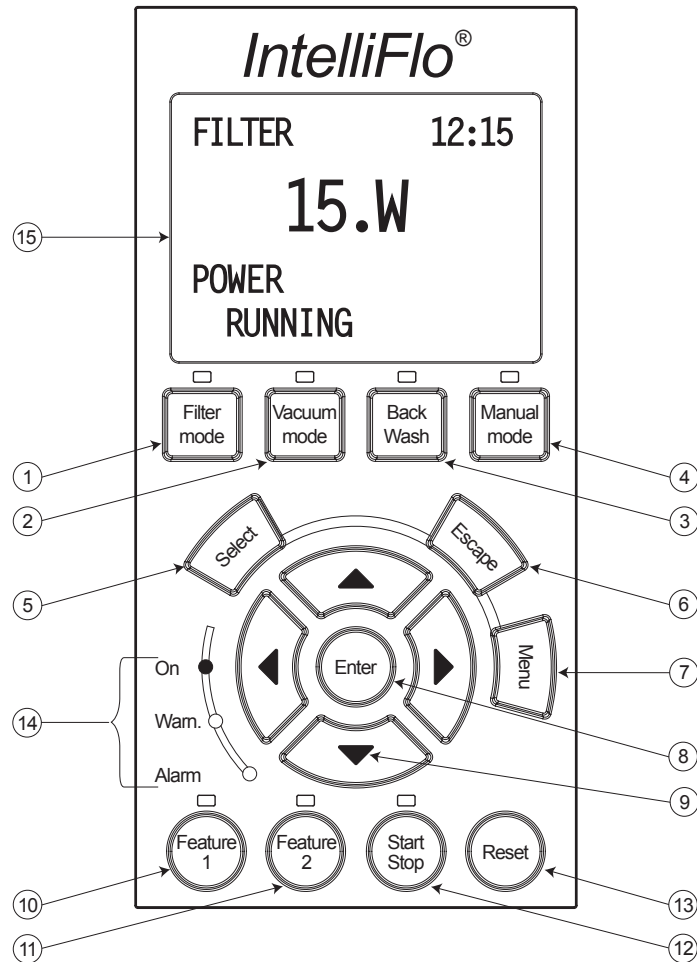

Controls and LEDs

- ① **Filter button/LED:** Starts Filter mode. The LED is on when Filter mode is active.
- ② **Vacuum button/LED:** Starts Vacuum mode. The LED is on when Vacuum mode is active.
- ③ **Backwash button/LED:** Starts Backwash mode. The LED is on when Backwash mode is active.
- ④ **Manual button/LED:** Starts Manual mode. The LED is on when Manual mode is active.
- ⑤ **Select button:** Display available menu items or enters edit mode for changing a value on line two of the display.
- ⑥ **Escape button:** Go to the next level up in the menu structure or stop editing the current setting.
- ⑦ **Menu button:** Access the menu items if the pump is stopped.
- ⑧ **Enter button:** Save current menu item setting. Also, press this button to acknowledge alarms and warning alerts.

Controls and LEDs (Continued)

- ⑨ **Arrow buttons:**
- **Up arrow:** Move one level up in the menu tree or increase a digit when editing a setting.
 - **Down arrow:** Move one level down in the menu tree or decrease a digit when editing a setting.
 - **Left arrow:** Move cursor left one digit when editing a setting.
 - **Right arrow:** Move cursor right one digit when editing a setting.
- ⑩ **Feature 1 button:** Starts Feature 1 mode. The LED is lit when mode is active.
- ⑪ **Feature 2 button:** Starts Feature 2 mode. The LED is lit when mode is active.
- ⑫ **Start/Stop button:** Start or Stop the pump. When the LED is lit it indicates that the pump is currently running or in a mode to start automatically.
- ⑬ **Reset button:** Reset alarm or alert.

LEDs

- ⑭ { **On:** This green LED is on when IntelliFlo is powered on.
- { **Warning:** This LED is on if a warning condition is present.
- { **Alarm:** This LED is on if an alarm condition has occurred.

⑮ **Control Panel LCD Display**











LCD Display Lines:

- **Line 1** - Mode and time. To set A.M. and P.M. time, refer to “Time and Contrast Menu” on page 22.
- **Line 2** - Data
- **Line 3** - Name of data in line 2
- **Line 4** - Run status













Navigating the Menu Structure

Before navigating the control panel menu structure, first familiarize yourself with the menu buttons. To change a parameter setting, use the **Left** and **Right** arrow buttons to select the digit, then the **Up** and **Down** arrow buttons to edit the digit. The following example shows how to set the GPM and priming time in the “Priming” menu (see page 14).

To set the “Priming” mode settings:

1. Ensure that the green power LED is on and the pump is stopped.
If the pump is running, press the  **Start/Stop** button.
2. Press the  **Menu** button. “Pool Data” is displayed.
3. Press the  **Down** arrow to select “Priming”.
4. Press the  **Select** button to access “Max Priming Flow” setting.
5. **Set the GPM:** Press the  **Select** button to set the gallons per minute (GPM) value.
6. To change the GPM value, press the  **Left** and **Right** arrows to select which digit to modify.
Press the  **Up** and **Down** arrows to change the selected digit. For setting values, see “Priming menu options” below.
7. When you are done, press the  **Enter** button to save the changes. To cancel any changes.
Press the  **Escape** button to exit edit mode without saving.
8. **Set the priming time:** Use the  **Up** and **Down** arrows to select “Max Priming Time” and “System Priming Time.”
Press the  **Select** to edit the setting.
9. Repeat steps **5**, **6**, and **7** to edit the setting.

Priming Mode Example

	MENU 12:15 Pool Data
	MENU 12:15 Priming
	Priming 12:15 55. GPM Max Priming Flow
	Priming 12:15 0055. GPM Max Priming Flow
	Priming 12:15 0055. GPM Max Priming Flow
	Priming 12:15 0065. GPM Max Priming Flow
	Priming 12:15 0065. GPM Max Priming Flow
	Priming 12:15 0060. GPM Max Priming Flow
5X	
	Priming 12:15 60. GPM Max Priming Flow
	Priming 12:15 15. MIN Max Priming Time
	Priming 12:15 0. MIN System Priming Time
	MENU 12:15 Priming

Blank Page

Section 3

Operating IntelliFlo

This section describes how to use the IntelliFlo pump control panel.

Metering the System

The first step to operating and programming IntelliFlo is to know what is being used in the pool system. After the devices are selected you can then set valves for the appropriate features and use the “Manual” mode to measure flow rates for the types or series of devices that require flow. When an appropriate flow rate or rates are found for a device or series of devices, you should note that flow rate for programming later.

Note: If the pool system uses a filter, always monitor pressure at the filter when changing the speed (RPM) or flow (GPM) from IntelliFlo.

Manual Mode

Operating IntelliFlo in manual mode is typically used for service and testing purposes only.

To operate IntelliFlo in manual mode:

1. Ensure that the green power LED is on.
2. Press the **Manual** button.
3. Use the **Up** and **Down** arrow buttons to view the current power, actual speed and flow:
 - **Power Menu (Watts):** Displays current power to the motor shaft in continuous watts
 - **Actual Speed (RPM):** Displays RPM speed when flow and RPM control is used
 - **Actual Flow (GPM):** Displays actual flow when using flow control
 - **Set Speed (RPM):** Set IntelliFlo to run at a continuous speed
 - **Set Flow (GPM):** Set IntelliFlo in flow control to allow the pump to change speed to manage the flow rate based on system changes

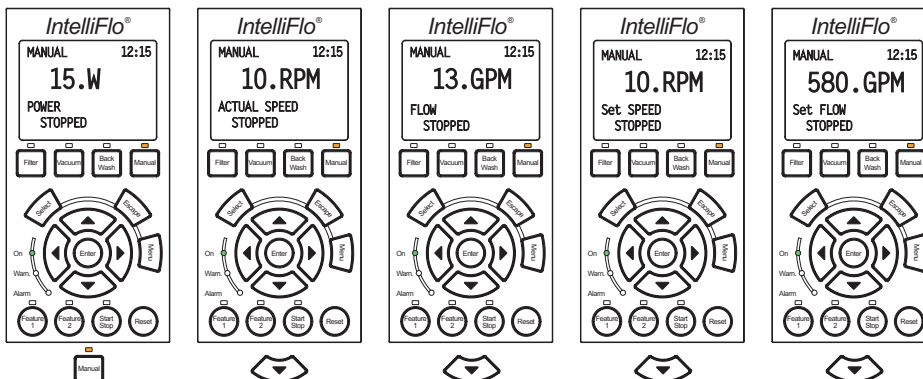

Note: No sensors except the flow control will work while in “Manual” mode. Suction Blockage will not work in this mode.

Manual Mode (Continued)

To change the Set Flow and Set Speed features:

1. Ensure that the green power LED is on.
2. Press the **Manual** button (LED is on).
3. **Set Flow:** Use the **Up** and **Down** arrow buttons to select **Set Flow**, then press the **Select** button to edit the setting.
4. To change the setting, press the **Left** and **Right** arrows to select which digit to modify, then use the **Up** and **Down** arrows to change the selected digit. The preset flow values can be set to 15 to 130 GPM (default 50 GPM).
5. When you are done, press the **Enter** button to save the changes. To cancel any changes, press the **Escape** button to exit edit mode without saving.
6. **Set Speed:** Use the **Up** and **Down** arrows to select **Set Speed**, then press the **Select** button to edit the setting. The preset speed can be set to 400 to 3450 RPM maximum (default 1000 RPM).

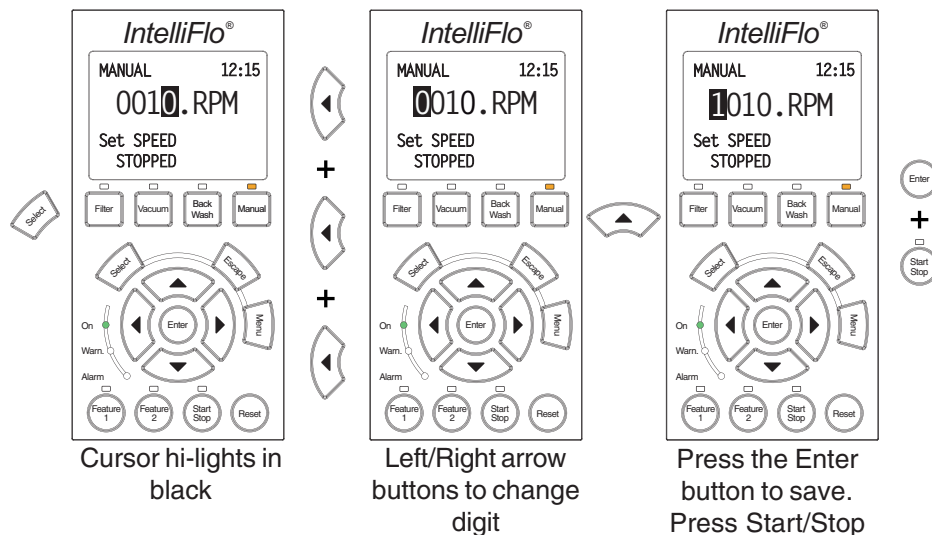

7. To change the setting, press the **Left** and **Right** arrows to select which digit to modify, then use the **Up** and **Down** arrows to change the selected digit.
8. When you are done, press the **Enter** button to save the changes. To cancel any changes, press the **Escape** button to exit edit mode without saving.

Manual Mode (Continued)

9. Press the **Start/Stop** button (LED is on) to run IntelliFlo in “Manual” mode (LED is on). The pump will start and control the flow or speed using the last settings made. After the button is pressed, the display shows “Running.” To stop IntelliFlo, press the **Start/Stop** button (LED is off). The display will show “Stopped.”

Note: While IntelliFlo is running in Manual mode, you can view the current power consumption and what actual speed is being used.

10. **Change Flow and Speed settings while the IntelliFlo is running:** The **Set Flow** and **Set Speed** settings can be changed on the fly while the pump is running. To change the flow and speed settings, perform steps 3 through 8.
 - When “Set Flow” is used IntelliFlo will prime then ramp to the current flow rate
 - It takes the IntelliFlo about 60 seconds to two minutes to find a flow rate after it is primed. This is best seen in Actual Speed status display
 - While changing the Set Flow setting, IntelliFlo will reprime after a value is changed
 - While changing the Set Speed setting, IntelliFlo will immediately ramp to the current speed
11. To stop the pump, press the **Start/Stop** button.

IntelliFlo Control Panel Menu

Use the control panel menu to setup and configure IntelliFlo.

To access the menu features:

- Ensure that the pump is stopped. Press the **Menu** button. Use the **Up** or **Down** arrow button to scroll through the menu items. Use the **Select** button to select a menu item. Press the **Enter** button to save a setting. Press the **Escape** button to move up a level from a selected menu item.

Menu Structure

The IntelliFlo menu structure is shown on the following page.

IntelliFlo Control Panel with IntelliComm or IntelliTouch

- The IntelliFlo control panel remains active when the IntelliFlo is connected to an IntelliComm. For more information see page 29.
- The IntelliFlo control panel is disabled when the Intelliflo is communicating with an IntelliTouch. "DISPLAY NOT ACTIVE!" will be displayed. For more information see page 31.

Main Menu

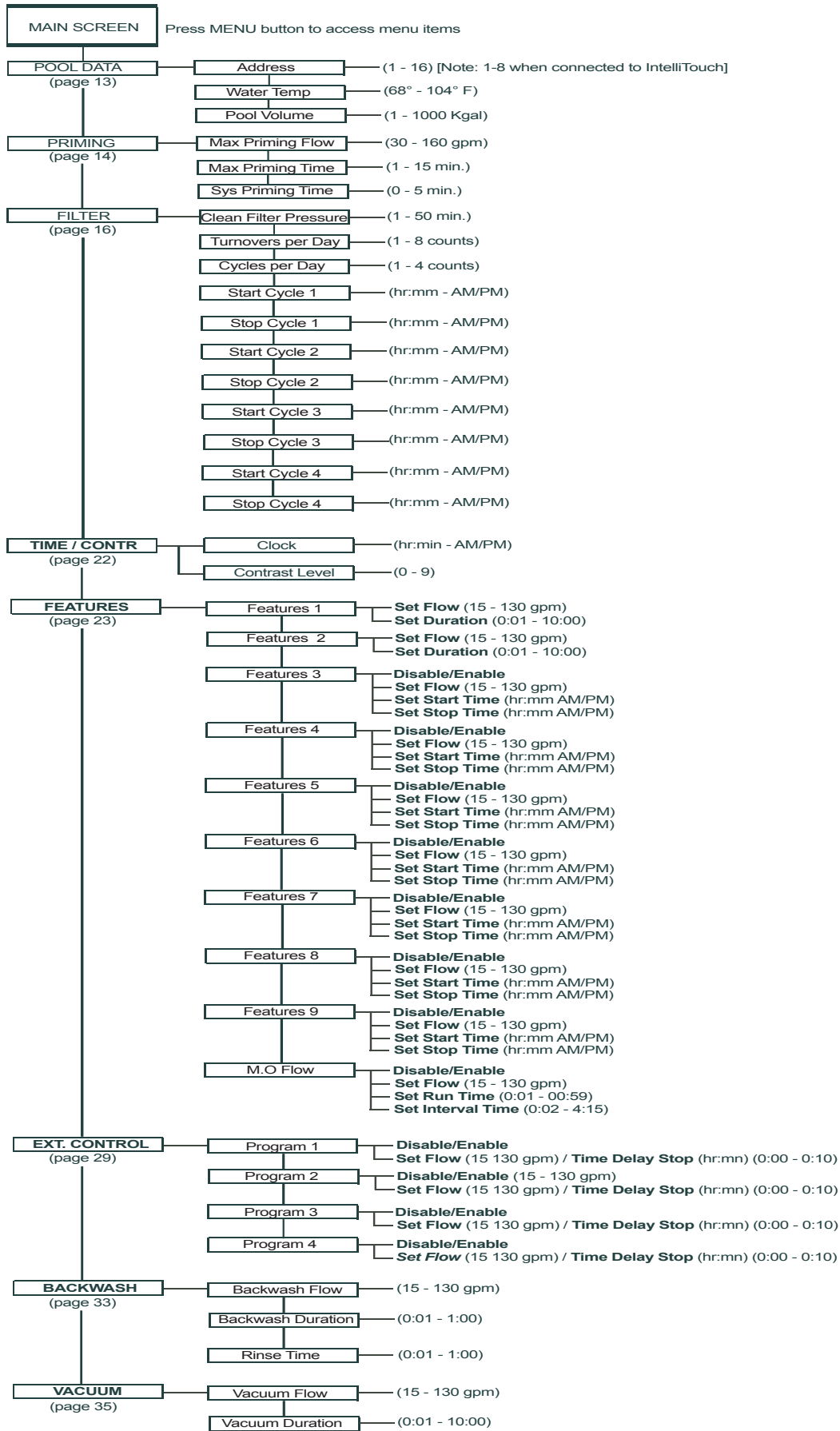

Pool Data Mode

Use the Pool Data menu to configure IntelliFlo for the pool and spa system. From this menu you can set an address for the IntelliFlo pump when connected to an IntelliTouch system, set the volume of pool water, in 1000's of gallons (kgal) and estimated pool water temperature.

To access the Pool Data menu:

1. Ensure that the green power LED is on and the pump is stopped.
2. Press the **Menu** button.
3. Press the **Up and Down** arrow buttons to scroll through the menu items. Press the **Select** button to access the “Pool Data” menu.
4. **To enter the pump volume (pool size):** Press the **Select** button to access “Pool Volume” setting. To enter the pool volume setting, see step 7.

The “Pool Volume” value is expressed as 1000's of gallons (Kgal). Enter from 1 to 1000 Kgal for the pool volume. The volume number can be a close estimate, although the more accurate the better the turns will be done when employing filter mode. Filter mode uses this value in coordination with the parameters from Filter mode to sustain turn rates, flows, and times.

5. **To set the water temperature:** Use the **Up and Down** arrows to select “Water Temperature”. To set the water temperature, see step 7.

Enter the current water temperature from 68° F - 104° F (Default 75° F.) The “Water Temp” is only for the accuracy of the flow sensor. Temperature accuracy is not critical, just enter an approximate temperature. When the IntelliFlo is connected to an IntelliTouch system, water and air temperature information is provided by the system sensors. The flow reading on the IntelliFlo is -0 / +2 GPM. The closer the temperature to the actual temperature, the more accurate the flow reading on the IntelliFlo control panel LCD will be while it's running.

6. **To enter the pump address:** Press the **Select** button to access the “Pump Address” setting. To enter the IntelliFlo pump address, see step 7.

This setting is only used if IntelliFlo is connected to the IntelliTouch system. The “Pump Address” identifies the pump number (1-16) that is displayed on the IntelliTouch control panel for programming. For example, if there are multiple IntelliFlo pumps, pump address 1 can be name as “Spa Pump,” in the IntelliTouch control panel. The IntelliTouch system can address and control up to eight different pumps using the RS-485 COM port connection. **Note:** *IntelliFlo pumps cannot be connected in series with other pumps. Check valves must be used when an IntelliFlo is used in parallel with other pumps.*

7. Press the **Select** button to change the current setting.
8. To enter a new setting, press the **Left and Right** arrows to select which digit to modify, then use the **Up and Down** arrows to change the selected digit.
9. When you are done, press the **Enter** button to save the changes. To cancel any changes, press the **Escape** button to exit edit mode without saving.

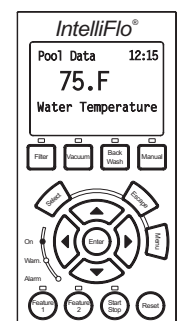
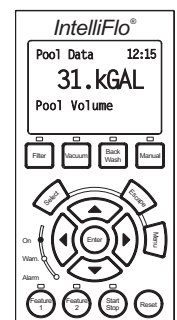
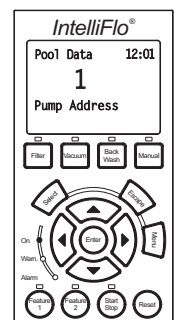
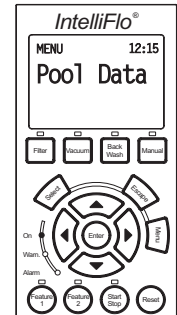

Priming Mode

To “prime” a pump means filling the pump and suction pipe with water. This process evacuates the air from all the suction lines and the pump. It may take several minutes to prime depending on the depth of water, pipe size and length. It is easier to prime a pump if you allow all the air to escape from the pump and pipes. The water cannot enter unless the air can escape. Pumps do not hold prime, the pool piping system has that task.

Priming is a function used every time the motor is started with a flow as reference. The “Priming Flow” function ensures the proper operation of the pump. The “System Priming Time” function ensures proper operation of the whole pool system. When the pump is priming, the control panel LCD displays “Priming” and then for a moment displays “Primed” when priming is complete.

CAUTION: To avoid permanent damage to the IntelliFlo pump, before starting the system, fill the IntelliFlo housing strainer with water so that the pump will prime correctly. If there is no water in the strainer the pump will not prime.

Priming Menu

To enter maximum priming flow (GPM):

1. Ensure that the green power LED is on and the pump is stopped.
2. Press the **Menu** button. “Pool Data” is displayed.
3. Press the **Up** or **Down** arrows to select the “Priming” menu.
4. **To set the Max Priming Flow (GPM):** Press the **Select** button to access the “Max Priming Flow” setting. To enter the maximum flow range (GPM) during the priming cycle, see step 7.

The “Max Priming Flow” value is entered as gallons per minute (GPM), from 30 to 160 GPM. The default is 55 GPM. The “Max Priming Flow” is a critical parameter for the pool and equipment. Every time the pump starts this parameter will negotiate the maximum flow of the pump. If the flow is too high, equipment damage can occur. If the flow is too low the pump will not prime. This “flow” is system dependent and may require iteration. The pump will never flow more than this parameter is set to, however, it is common for the pump to ramp up and down quickly while priming. Always try to keep this flow as low as possible for cost savings and safety.

5. **To set the Max Priming Time:** Press the **Select** button to access the “Max Priming Time” setting. To enter the maximum time for priming before “PRIMING ERROR”, see step 7 on the following page.

The “Max Priming Time” value is entered in minutes, from 1 to 15 minutes. The default is 15 minutes. Use this parameter to set the time that you want IntelliTouch to try and prime before it reports an error. Remember that the IntelliFlo will attain prime every time it starts and goes through this cycle. The IntelliFlo mechanical seal can withstand about 15 minutes before severe damage occurs. You can set this range between 1 minute to 15 minutes. The lower the time the quicker you will get a priming error if the system is difficult to prime. A well plumbed pool without having the strainer removed should prime in less than 30 seconds. If the strainer has been removed for cleaning and a substantial amount of air is in the system it should prime in about 60 to 90 seconds on the average, however, all systems will be different.

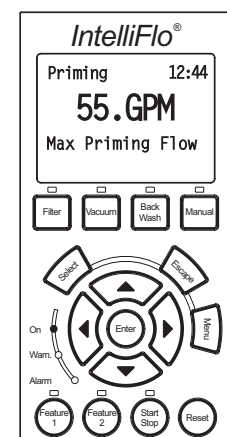
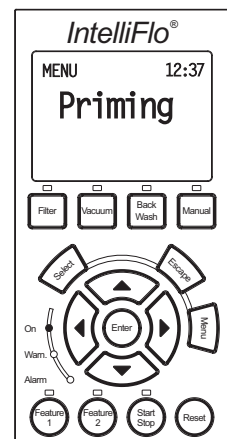

Priming Mode (Continued)

6. **To set the System Priming Time:** Press the **Select** button to access the “System Priming Time” setting. After the pump is primed it will take sometime before the system is primed. This time is called “System Priming Time” To enter the maximum system priming time, see step 7.

The “System Priming Time” value is entered in minutes, from 0 to 5 minutes. The default is 0 minutes. Remember that the average unit will prime in a short period of time because the IntelliFlo has the ability to monitor itself to make sure it is primed. “System Priming Time” is for systems that require high flows that priming flow can provide but it is deemed that more time is needed to fully relieve all the air. The builder can program a pre determined amount of time, up to 5 minutes, to aid in relieving the air from difficult filters or complex vertical plumbing. The “System Priming Time” should only be used where large air traps become problems within the system. The display will inform the user when this is engaged and when it is finished during the priming cycle at each start up cycle.

7. Press the **Select** button to change the current value.
8. To change the value, press the **Left** and **Right** arrows to select which digit to modify, then use the **Up** and **Down** arrows to change the selected digit.
9. When you are done, press the **Enter** button to save the changes. To cancel any changes, press the **Escape** button to exit edit mode without saving.

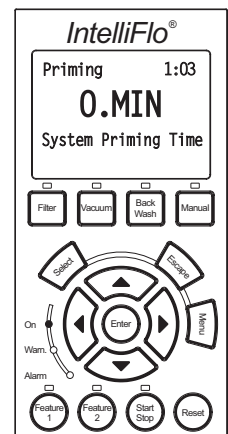
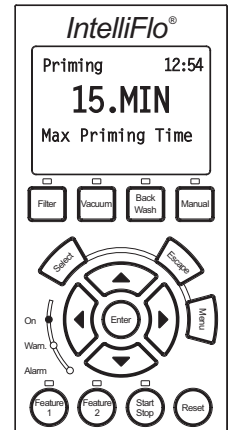

Filter Mode

IntelliFlo will calculate the required flow rate based on pool size, clean filter pressure, pool turns per day and cycles per day, and will control the motor speed to keep a constant flow. The filter mode can run cycles, power save or features. The IntelliFlo internal scheduler will keep track of which function to run. IntelliFlo is constantly monitoring the filter, when it detects that the system is dirty, it will display an “Alert - Service System Soon” message on the control panel display. The user must then clean the filter by performing a Backwash cycle (see page 33).

Filter Menu

To access the Filter menu settings:

1. Ensure that the green power LED is on and the pump is stopped.
2. Press the **Menu** button. Press the **Up** or **Down** arrows to select the “Filter” menu. Press the **Select** button, “Clean Filter Pressure” is displayed.
3. **To set the Clean Filter Pressure:** Press the **Select** button to access the “Clean Filter Pressure” setting. To edit the pressure setting, see step 6 on the following page.

This parameter can be set from 1 PSI to 50 PSI. The average setting should be between 10 PSI and 20 PSI for most pools and filters. The entered PSI value splits the percentage meter for the filter. The “Service System Soon” alert is activated by the entered PSI value. When this value is reached the pump stops monitoring flow rates and starts managing pressure. The value represents the change in pressure over time from start up (system clean) to present day (system getting dirty). The changes can come from anywhere in the system, for example clogged skimmers or pots in pumps. For more information, refer to “Clean Filter Pressure” on page 19.

4. **To set the Turnovers Per Day:** Press the **Select** button to access the “Turnovers Per Day” setting. To edit this setting, see step 6 on the following page.

This setting is the number of times you wish to turn over the water that is setup in the “Pool Volume” part of the “Pool Data” menu (see page 13).

You can set up to eight turns per day. It is recommended that one turn per day for energy conservation and requirements be performed for most common residential pools. Refer to sanitizer recommendation for additional information.

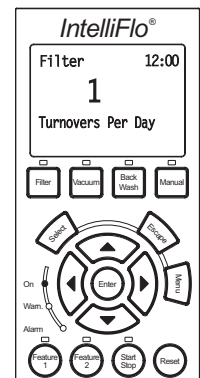
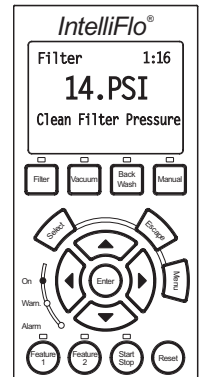
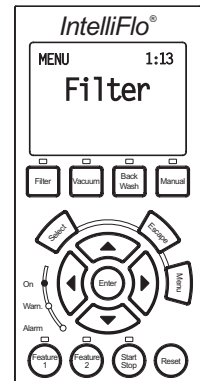

Filter Mode (Continued)

- To set the **Cycles Per Day**: Press the **Select** button to access the “Cycles Per Day” setting. To edit this setting, see step 6.

IntelliFlo uses the Cycles Per Day parameter to calculate how much time it has to complete its filter job. You can program up to four start and stop cycles per day. The more time the IntelliFlo is given to operate the less power and flow will be needed for turning over the pool.

***Note:** Consumers in certain areas are charged lower energy rates at non-peak hours. To take advantage of this, the IntelliFlo can be programmed to run at any time of the day. The extremely quiet operation of the IntelliFlo makes it feasible to operate during the early morning or late at night. The easiest and best way to optimize flow during filter cycles is by adding or subtracting cycle time. This way, the desired flow effect, for example, skimming action, can be achieved while maintaining the desired water turnover rate.*

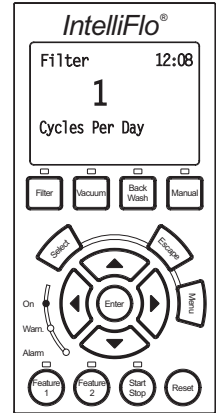

- Press the **Select** button to change the current value.
- To change the value, press the **Left** and **Right** arrows to select which digit to modify, then use the **Up** and **Down** arrows to change the selected digit.
- When you are done, press the **Enter** button to save the changes. To cancel any changes, press the **Escape** button to exit edit mode without saving.

Programming Cycles Per Day

Each cycle has two screens, one for the “Start Cycle” and one for “Stop Cycle”. The following examples shows one for the cycle start/stop time. Only one cycle is entered in the “Cycles Per Day” parameter.

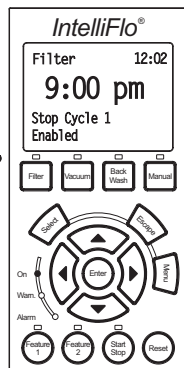
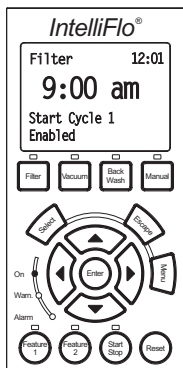

Start and Stop Cycle is displayed

Enabled or disabled is displayed depending on how many cycles are selected

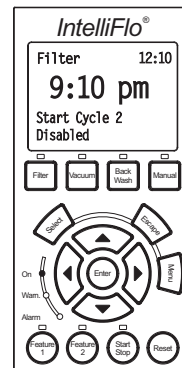

This screen shows the filter cycle as “Disabled” for a start/stop cycle (Cycles Per Day programmed to 1). These screens will still display even if they are not enabled.

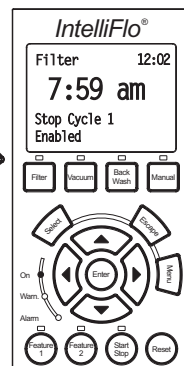
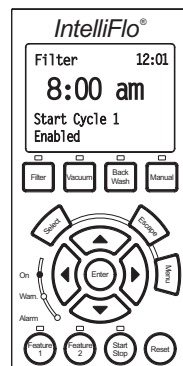

This example will run the pump for 24 hours. Start and Stop Cycle is displayed

Enabled or disabled is displayed depending on how many cycles are selected

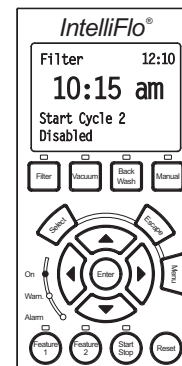

This screen shows the filter cycle as “Disabled” for a start/stop cycle (Cycles Per Day programmed to 1). These screens will still display even if they are not enabled.

Filter Mode (Continued)

Filter Cycle Settings

Note: The control panel is disabled when the IntelliFlo is communicating with an IntelliTouch. "DISPLAY NOT ACTIVE!" will be displayed.

NAME	VALUE	DESCRIPTION
Turnovers Per Day	1-8 (Default 1)	The number of times per day the volume of water setup in "Pool Volume" will be moved.
Cycles per Day	1-4 Cycles (Default 1)	The number of cycles (start and stop) the IntelliFlo must do per day.
Clean Filter Pressure	1-50 PSI (Default 14 PSI)	The differential pressure from the 0-pressure to 100% filter status.
Start Cycle 1	1:00 -12:59 HH.MM am/pm (Default 9:00 am)	Start time for cycle 1 (if start and stop is the same time the IntelliFlo will run 24*7).
Stop Cycle 1	1:00 -12:59 HH.MM am/pm (Default 9:00 pm)	Stop time for cycle 1 (if start and stop is the same time the IntelliFlo will run 24*7).
Start Cycle 2	1:00 -12:59 HH.MM am/pm (Default 9:10 pm)	Start time for cycle 2. If "Cycles per day" is below 2, "OFF" will be shown in the display and data cannot be entered.
Stop Cycle 2	1:00 -12:59 HH.MM am/pm (Default 9:20 pm)	Stop time for cycle 2. If "Cycles per day" is below 2, "OFF" will be shown in the display and data cannot be entered.
Start Cycle 3	1:00 -12:59 HH.MM am/pm (Default 9:30 pm)	Start time for cycle 3. If "Cycles per day" is below 3, "OFF" will be shown in the display and data cannot be entered.
Stop Cycle 3	1:00 -12:59 HH.MM am/pm (Default 9:40 pm)	Stop time for cycle 3. If "Cycles per day" is below 3, "OFF" will be shown in the display and data cannot be entered.
Start Cycle 4	1:00 -12:59 HH.MM am/pm (Default 9:50 pm)	Start time for cycle 4. If "Cycles per day" is below 4, "OFF" will be shown in the display and data cannot be entered.
Stop Cycle 4	1:00 -12:59 HH.MM am/pm (Default 10:00 pm)	Stop time for cycle 4. If "Cycles per day" is below 4, "OFF" will be shown in the display and data cannot be entered.

Based on "Pool Volume", "Turnovers per day" and the total number of hours for Cycle 1 + 2 + 3 + 4 the flow must be calculated:

$$Flow = \frac{"PoolVolume" \times "Turnovers pr day"}{Cycle1 + Cycle2 + Cycle3 + Cycle4}$$

Note: Only enabled cycles are included in the calculation

Filter Mode (Continued)

Clean Filter Pressure Example

The following example shows the “Clean Filter Pressure” set to 14 PSI.

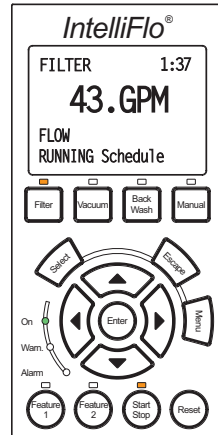

Pump newly installed and system run for the first time

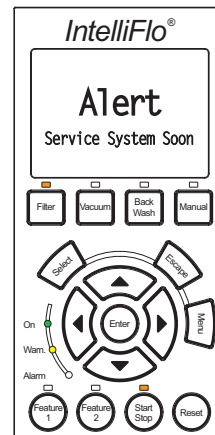
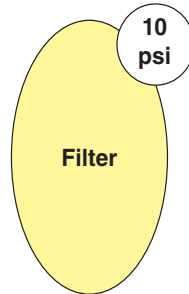

12 months later filter attains 24 psi of internal pressure which is a 14 psi increase

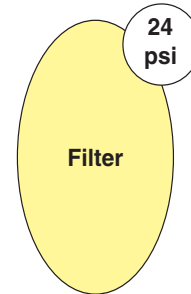

Alert Status

Once the “Alert” is triggered the yellow warning LED is lit and “Alert” is displayed on the screen. The pump will reduce speed to maintain 14 PSI of head pressure and stop managing flow. Note the following:

- The % clean filter pressure has reached 100%.
- If parameter is set to 14 PSI every 10% on the display is 1.4 psi on the filter.
- If the parameter is set to 10 PSI every 10% on the display is 1 psi on the filter.
- The filter must be cleaned or backwashed to reduce the pressure. Even if the system has a cartridge filter the IntelliFlo must be started in Backwash Mode with a clean filter to reset the fault and "zero" the IntelliFlo's filter status reading.

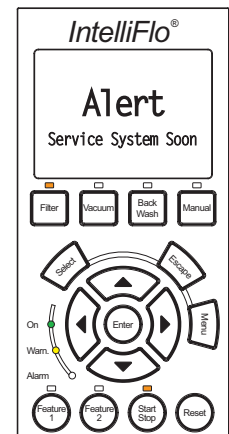

Note: For a complete list of IntelliFlo alert warnings, refer to “Alert and Warning” on page 49.

Filter Mode (Continued)

Using Filter mode with Features mode

IntelliFlo will start and stop at programmed filter cycles 1-4. The filter cycles can be overridden by “Feature” (3-9 only) as shown in the example below. This may cause the required filter volume to be achieved earlier.

The “Feature” function is allowed to take control during “Filter” mode. When the feature function stops, IntelliFlo will continue in “Filter” mode. If only Feature 3-9 is active during a filter cycle, IntelliFlo will calculate a new filter cycle.

Example: The IntelliFlo was suppose to run in Filter mode from 1:00 to 11:00 to turnover 10 GPM for 10 hours (10 GPM 10 Hours= 6 kGal).
But because Feature 3 has been running 20 GPM for 4 hours (20 GPM 4 Hours= 4,8 kGal), the IntelliFlo must stop at 8:00 because; 10 GPM* 3 Hours + 20 GPM 4 Hours= 6,6 kGal.

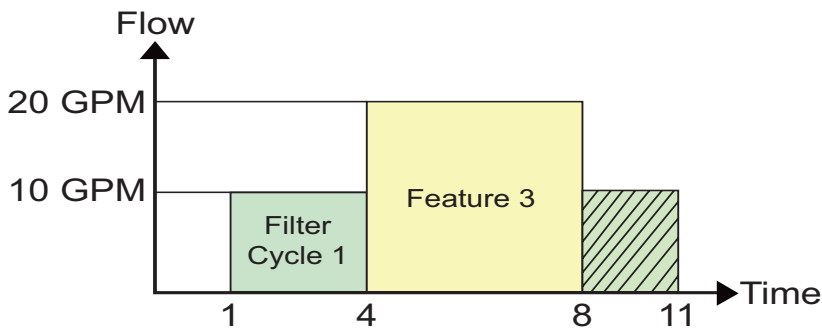

“Feature” 1 and 2 do not have time-of-day functions and do not affect the filter cycle time. The active time for “Feature” 1 and 2 will not be calculated into the reduced cycle time as shown in the above example.

Filter Mode (Continued)

Flow Control and Filter Mode

The Filter Mode feature provides the ability of overcoming head pressure loss to provide the required flow through the plumbing. The flow that the unit can provide is limited by the installed plumbing. If more flow is demanded than the IntelliFlo can provide, it will ramp to full speed and create pressure.

The following example shows a ramp as flow increases from 50 to 75 GPM.

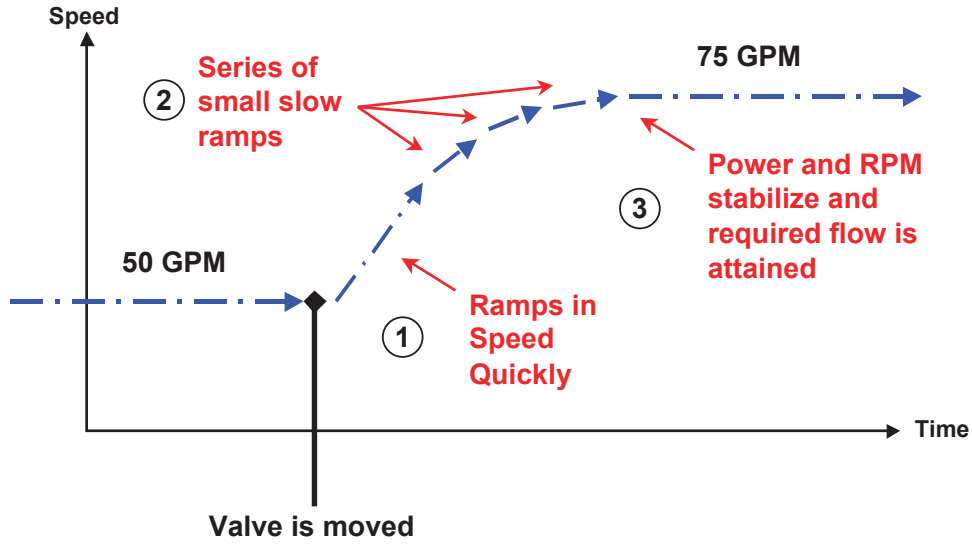

Time and Contrast Menu

Use the “Time and Contr” menu settings to set the IntelliFlo system clock and to adjust the control panel display contrast. The IntelliFlo system clock controls all scheduled start and stop times, functions, and programmed cycles. The system clock can store the correct time for up to 96 hours after power is shut off. After 96 hours the clock must be reset to the correct time.

Setting System Time

To set the IntelliFlo system clock:

1. Ensure that the green power LED is on and the pump is stopped.
2. Press the **Menu** button. “Pool Data” is displayed.
3. Press the **Up** or **Down** arrows and select “Time/Contr.”
4. Press the **Select** button to access “Time/Contr” setting.
5. Press the **Select** button to change the current minutes and hour.
6. To change the minute and hour digits, press the **Left** and **Right** arrow buttons to select which digit to modify, then use the **Up** and **Down** arrow buttons to change the selected digit. Note, that the hours selection is from 01 to 11 for A.M. and P.M. The system time is displayed on the main screen, A.M. and P.M. are not displayed.
7. Press the **Enter** button to save the setting.

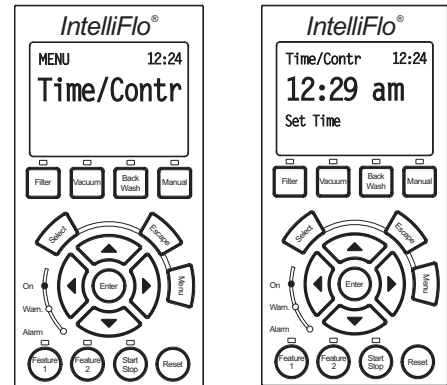

Setting the LCD Backlight Contrast

To change the contrast of the control panel display :

1. Ensure that the green power LED is on and the pump is stopped.
2. Press the **Menu** button. “Pool Data” is displayed.
3. Press the **Up** or **Down** arrows and select “Time/Contr.”
4. Press the **Select** button.
5. Press the **Up** or **Down** arrows and select “Contrast Level.”
6. Press the **Select** button. The contrast levels are 0 to 9. Avoid using 0 unless screen is unreadable in bright sun
7. Press the **Enter** button to save the setting.

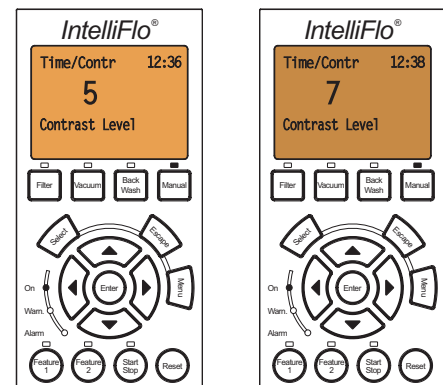

Features Mode

The Feature mode can be used with water features such as spa, cleaner, waterfalls, etc. You can schedule start and stop times for each feature. All Features are operated using Flow control. The Feature mode and Filter mode are run simultaneously. The three types of features are; Features 1 & 2, Features 3 -9 and M.O. Flo:

Features 1 and 2

Feature 1 and Feature 2 run for a pre-defined duration with a specifically set flow. If Feature 1 or Feature 2 buttons are pressed, all other Features are temporarily deactivated. Feature 1 or Feature 2 cannot be used in Backwash Mode. Features 1 and 2 have a higher priority than the pre-programmed Features 3-9. After the preset duration time for the Feature 1(2), IntelliFlo will switch back to the “Filter” mode if the IntelliFlo was in “Filter” mode when the Feature 1 (2) button had been pressed. After the preset duration time for the Feature 1(2), the IntelliFlo will switch back to the “Manual” mode if IntelliFlo was in “Manual” mode when the Feature 1 (2) button had been pressed.

Features 3 -9

Features 3 through 9 are only active in Filter mode. These features run a set flow for a specified time. The Features 3-9 can not overlap.

M. O. Flo

The M. O. Flo feature automatically increases the pump flow to allow the system heater to check the water temperature and switch on if necessary. This feature is only active when the pump is running a filter cycle. Once the heater checks for heat and discovers it must fire it will send a signal back to IntelliFlo to go into “Heater” mode. M.O. Flo only works during the “Filter” mode selected time cycles

Features Mode (Continued)

Feature Settings

Name	Value	Description
F1-9 and M.O. Flo Set Flow	15-130 GPM (Default 50 GPM)	Pre-set flow for feature 1 - 10
F3-10: Activate Feature	Enabled / Disabled (Default Disabled)	If value in line 1 is set Enabled the Feature will be active. If value in line 1 is set Disabled the Feature will be turned off.
F1-2: Duration Time	0-10 Hours (Default 00:01)	The time duration for feature 1 and 2. The duration must be selected for Feature 1 and 2.
F3: Start time	12:00 AM - 11:59 PM (Default 06:00 am)	Start time for feature 3
F3: Stop time	12:00 AM - 11:59 PM (Default 06:10 am)	Stop time for feature 3
F4: Start time	12:00 AM - 11:59 PM (Default 06:20 am)	Start time for feature 4
F4: Stop time	12:00 AM - 11:59 PM (Default 06:30 am)	Stop time for feature 4
F5: Start time	12:00 AM - 11:59 PM (Default 06:40 am)	Start time for feature 5
F5: Stop time	12:00 AM - 11:59 PM (Default 06:50 am)	Stop time for feature 5
F6: Start time	12:00 AM - 11:59 PM (Default 07:00 am)	Start time for feature 6
F6: Stop time	12:00 AM - 11:59 PM (Default 07:10 am)	Stop time for feature 6
F7: Start time	12:00 AM - 11:59 PM (Default 07:20 am)	Start time for feature 7
F7: Stop time	12:00 AM - 11:59 PM (Default 07:30 am)	Stop time for feature 7
F8: Start time	12:00 AM - 11:59 PM (Default 07:40 am)	Start time for feature 8
F8: Stop time	12:00 AM - 11:59 PM (Default 07:50 am)	Stop time for feature 8
F9: Start time	12:00 AM - 11:59 PM (Default 08:00 am)	Start time for feature 9
F9: Stop time	12:00 AM - 11:59 PM (Default 08:10 am)	Stop time for feature 9
F10: M.O.Flo Run time	0-10 minutes (Default 1 min)	"Run time" is the time for which the M.O.Flo function is running at the set flow
F10: M.O.Flo Interval time	0 - 255 minutes (Default 60 min)	"Interval time" is the time between activation of the "set flow" value for M.O.Flo

Features Mode (Continued)

The functions of the Features groups are shown below:

How to set up the Feature 1 or 2 (Flow and Duration) mode

To access the Features menu:

1. Ensure that the green power LED is on and the pump is stopped.

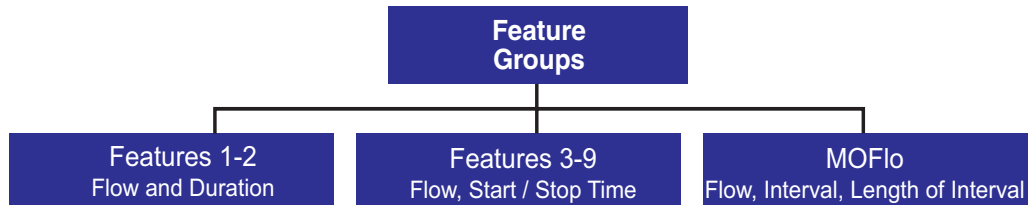

2. Press the **Menu** button. Press the **Up** or **Down** arrows to select the “Features” menu. Press the **Select** button to access the Feature 1 menu settings. The Features 1 menu setting is displayed.
3. **To set the flow rate for Feature 1 or 2:** Press the **Select** button to access the Feature 1 “Set Flow” setting. To edit the flow rate (GPM) setting, see step 6.
4. **To set the duration for Feature 1 or 2:** Press the **Select** button to access the Feature 1 “Duration” setting. To edit the time (hours and minutes) setting, see step 6.
5. Press the **Select** button to change the current value of Feature 1 or 2.
6. To change the value, press the **Left** and **Right** arrows to select which digit to modify, then use the **Up** and **Down** arrows to change the selected digit.
7. When you are done, press the **Enter** button to save the changes. To cancel any changes, press the **Escape** button to exit edit mode without saving.

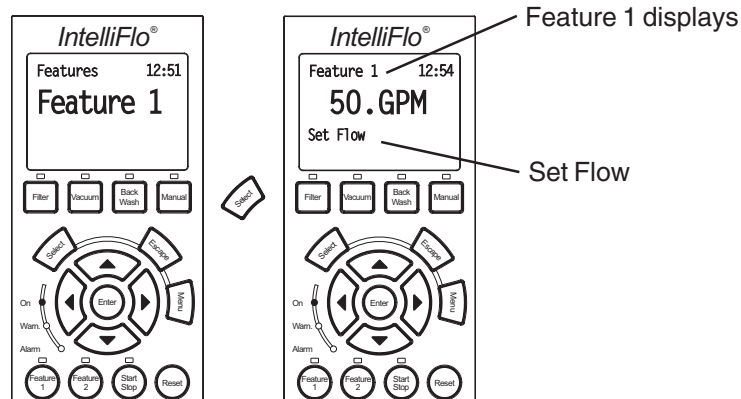
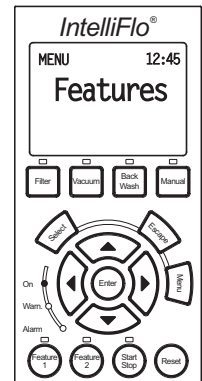

Features 1 – 2 (Flow and Duration)

To run Feature 1 or 2 (Flow and Duration)

1. Press the **Feature 1** or **Feature 2** button, then press the **Start/Stop** button. The active feature LED will be on until the process is finished.
2. The Features screen will then start to subtract time in minutes from your duration or you can scroll using the **Up** or **Down arrow** buttons to see the power, speed, or flow status.

The following screen shown Feature 1 initiated:

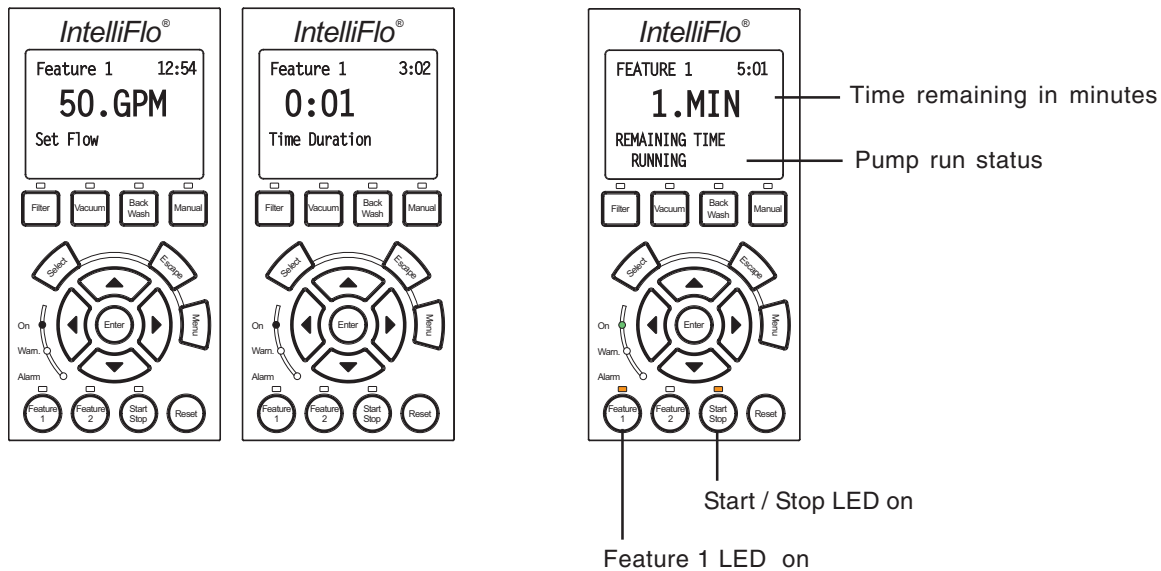

Features 3 – 9 (Flow, Start/Stop Time)

Feature 3 – 9 affect the “Filter” mode as shown on page 20.

Feature 3 – 9 are programmed by a flow rate and a start/stop time and are automatically initiated. They are controlled by the time of day. All alerts and alarms are active in Feature mode. Feature 3 – 9 must be enabled in its menu.

Enabling Features 3 – 9

To use any Feature 3 – 9 it must be first enabled. If it is not enabled, it will not work with the parameters in the “Set Flow” and “Set Start Time” and “Set Stop Time” settings. Features 3 – 9 are each programmed in the same way. Three parameters are required after Enabling; Flow, Start, and Stop.

To use the Feature 3 settings; Enabled, Set Flow, Set Start Time, and Set Stop Time:

1. Ensure that the green power LED is on and the pump is stopped.
2. Press the **Menu** button. Press the **Up** or **Down** arrows to select the “Features” menu. Press the **Down arrow** button to select **Feature 3**. Press the **Select** button to access the Feature 3 menu settings. The Features 3 menu setting is displayed.

3. **To enable Feature 3:** Press the **Select** button then the **Down arrow** button to select **Enabled** if not already selected. Press the **Enter** button to save the setting.
4. **To set the flow rate for Feature 3:** Press the **Down arrow** button to select “Set Flow” setting. Press the **Select** button to access the setting. To edit the flow rate (GPM) setting, see step 6.
5. **To set the start and stop time for Feature 3:** Press the **Down arrow** button to select “Start Time” or “Stop Time” setting. Press the **Select** button to access the setting. To edit the start and stop time, see step 6.
6. Press the **Select** button to change the current value.
7. To change the value, press the **Left** and **Right** arrows to select which digit to modify, then use the **Up** and **Down** arrows to change the selected digit.
8. When you are done, press the **Enter** button to save the changes. To cancel any changes, press the **Escape** button to exit edit mode without saving.

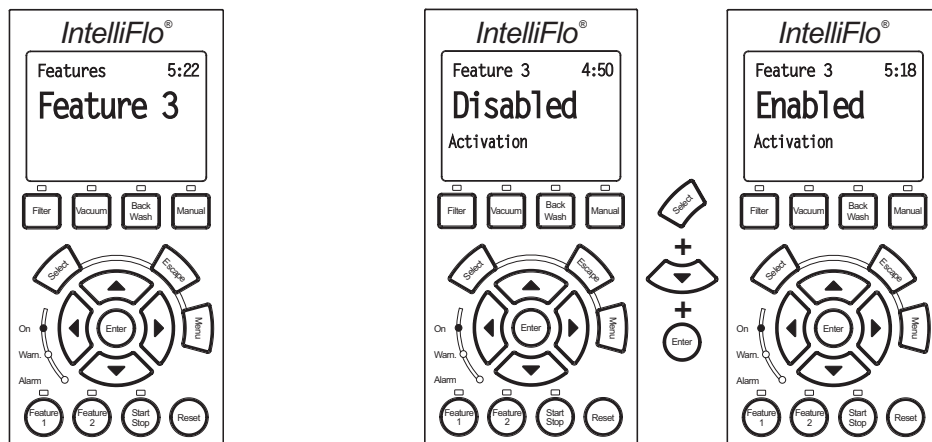

Filter Cycle Examples

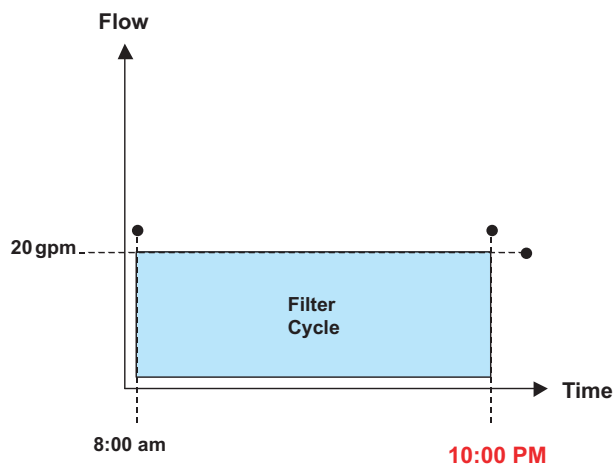

Original Filter Cycle w/No Timed Feature

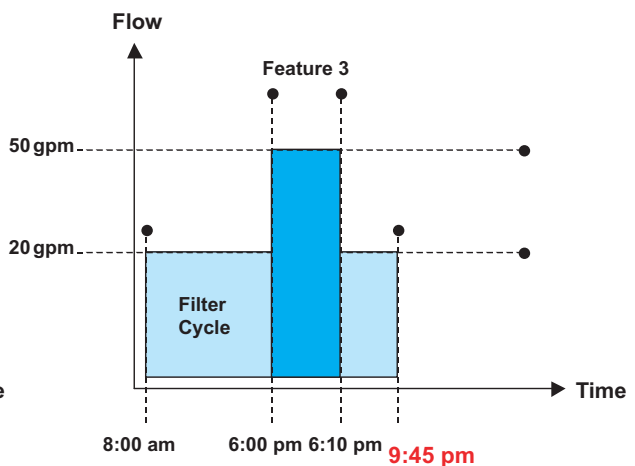

New Flow/Time Optimized Filter Cycle

Note: Refer to page 20 for further explanation.

Mo Flo (Modulation Output Flow)

M.O. Flo (Modulated Output Flow) is specifically designed for Pentair branded heaters with an IntelliComm, although it can be used for other functions, such as water effects. This feature allows you to have flexibility in flow control if the filter cycle flow is less than needed for certain devices. M.O. Flo also allows you to program intervals of flow separated by a specific duration which can be useful for water effects.

To setup the M.O. Flow option:

1. Ensure that the green power LED is on and the pump is stopped.
2. Press the **Menu** button. Press the **Up** or **Down** arrows to select the “Features” menu. Press the **Down arrow** button to select **M.O. Flo**. Press the **Select** button to access the M.O. Flow menu settings. The M.O.Flow “Activation” setting is displayed.
3. **To enable M.O. Flo:** Press the **Select** button then the **Down arrow** button to select **Enabled** if not already selected. Press the **Enter** button to save the setting.
4. **To set the flow rate for M.O. Flo:** Press the **Down arrow** button to select “Set Flow” setting. Press the **Select** button to access the setting. To edit the flow rate (GPM) setting, see step 6.
5. **To set the run and interval time for M.O. Flo:** Press the **Down arrow** button to select “Set Run Time” or “Set Interval Time” setting. Press the **Select** button to access the setting. To edit the start and stop time, see step 6.
6. Press the **Select** button to change the current value.
7. To change the value, press the **Left** and **Right** arrows to select which digit to modify, then use the **Up** and **Down** arrows to change the selected digit.
8. When you are done, press the **Enter** button to save the changes. To cancel any changes, press the **Escape** button to exit edit mode without saving.

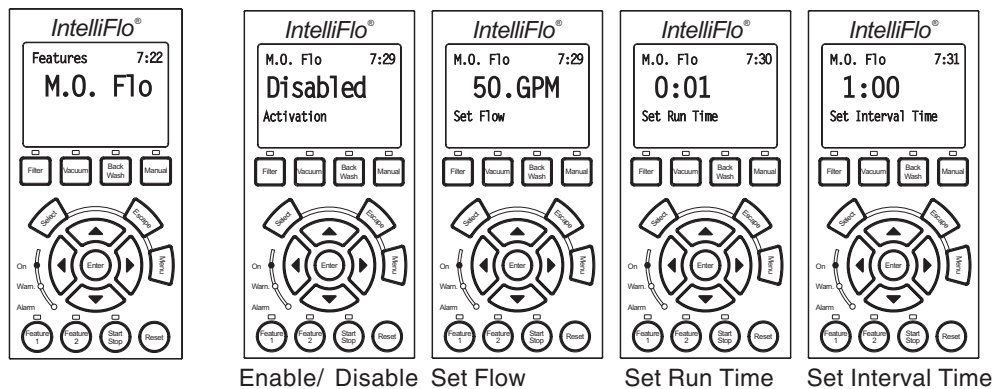

The following graphical representation shows when the M.O. Flo feature is enabled.

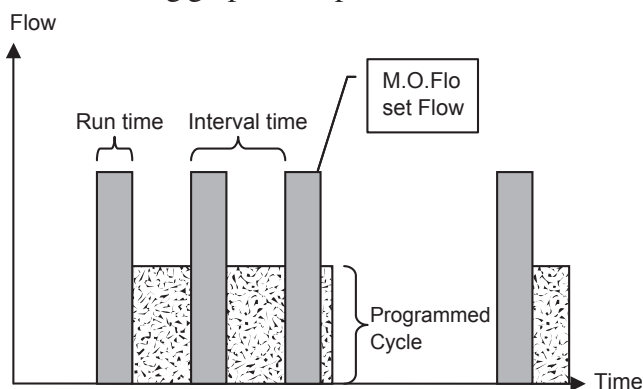

External Control with IntelliComm Communication Center

The IntelliFlo can be remotely controlled by the Pentair IntelliComm Communication Center using an optional communications cable (P/N 350122). The IntelliComm provides four pairs of input terminal connections. These inputs are actuated by either 15 - 240 VAC or 15 - 100 VDC. Using the device's inputs, the IntelliFlo external control Programs 1-4 can be controlled.

If more than one input is active the highest number will be communicated to the IntelliFlo pump. The IntelliComm will always communicate to pump address 1. The IntelliFlo control panel remains active when the IntelliFlo is connected to the IntelliComm.

The following table shows the wiring terminal descriptions for IntelliComm.

External Control



IntelliComm Communication Center

Terminal number	Terminal name	Voltage	Maximum current	Phase type	Frequency
1-2	Power supply	100 - 240 VAC	100 mA	1 Input	50/60 Hz
3-4	Program 1	15 -240 VAC or 15 - 100 VDC	1 mA*	1 Input	50/60 Hz
5-6	Program 2	15 -240 VAC or 15 - 100 VDC	1 mA*	1 Input	50/60 Hz
7-8	Program 3	15 -240 VAC or 15 - 100 VDC	1 mA*	1 Input	50/60 Hz
9-10	Program 4	15 -240 VAC or 15 - 100 VDC	1 mA*	1 Input	50/60 Hz
11 12	RS-485 + Data: Yellow - Data: Green	-5 to +5 VDC	5 mA	1 Output	N/A
	Ground				

External Control (Continued)

Setting up External Control using IntelliComm

The IntelliComm communication center is activated by the device voltage when it switches on and off which in turn enables any one of the IntelliFlo Programs 1-4. When the signal stops, the IntelliFlo will default back to its cycle programming. The IntelliFlo will always override to its largest command flow rate.

Note: The IntelliFlo control panel remains active when the IntelliFlo is connected to the IntelliComm.

To access the Ext. Ctrl. menu:

1. Ensure that the green power LED is on and the pump is stopped.

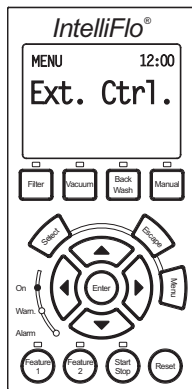

2. Press the **Menu** button. Press the **Up** or **Down** arrows to select the “Ext. Ctrl.” menu. Press the **Select** button to select “Program 1” menu settings.
3. Use the **Up** and **Down** arrow buttons to scroll through the programs; Program 1, Program 2, Program 3, and Program 4. Each program has three parameters, Enable/Disable, Flow (GPM), and Time Delay stop. When the program is active, it will display the program name on the screen. To edit a setting, see step 4.
4. Press the **Select** button to change the current value.
5. To change the value, press the **Left** and **Right** arrows to select which digit to modify, then use the **Up** and **Down** arrows to change the selected digit.
6. When you are done, press the **Enter** button to save the changes. To cancel any changes, press the **Escape** button to exit edit mode without saving.

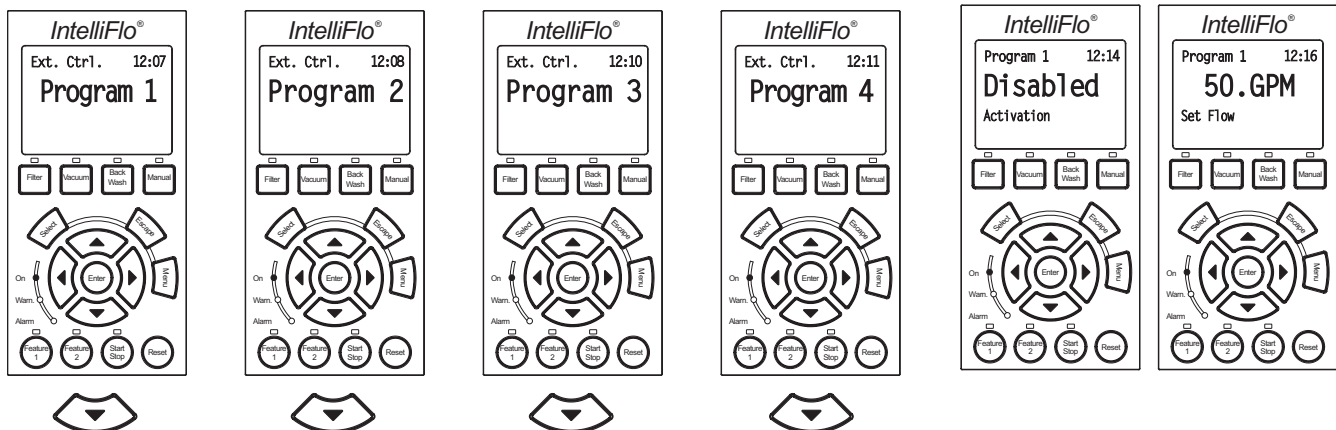

Controlling IntelliFlo with the IntelliTouch

The IntelliFlo pump can be controlled by an IntelliTouch system via the RS-485 communication cable. In this configuration IntelliTouch starts and stops the IntelliFlo. IntelliTouch also rewrites many of the parameters in the IntelliFlo drive's memory, such as the filter cycle start and stop times, pool size and the clock. The transfer of this data takes several seconds and causes a delay from when the command is given from the IntelliTouch indoor control panel until the IntelliFlo physically responds. Frequently, these changes to the IntelliFlo parameters will cause the pump to stop while it recalculates internal parameters and then restart. This happens automatically but may take 1-2 minutes to complete.

The IntelliFlo LCD control panel is disabled when communicating with the IntelliTouch system and "DISPLAY NOT ACTIVE" will be displayed. Note that IntelliTouch will not start communicating with the IntelliFlo until the pump is assigned an IntelliTouch circuit name. For more information, refer to the IntelliTouch User's Guide (P/N 520102).

Connecting IntelliFlo to IntelliTouch

Connection from IntelliFlo to the IntelliTouch system is via the optional two-wire cable (P/N 350122). The cable pinout is shown on page 32.

To connect the IntelliFlo cable to the IntelliTouch load center:

1. **⚠ CAUTION - Switch the main power off to the IntelliTouch load center.**
2. Unlatch the IntelliTouch load center front door spring latches, and open the front door.
3. Remove the cover-panel screws securing the high voltage cover-panel, and remove it from the enclosure.
4. Loosen the two control panel access screws and fold down the outdoor control panel.
5. Insert the two-wire cable into plastic grommet on the bottom of the enclosure and route the wire up through the low voltage raceway to the Personality board.

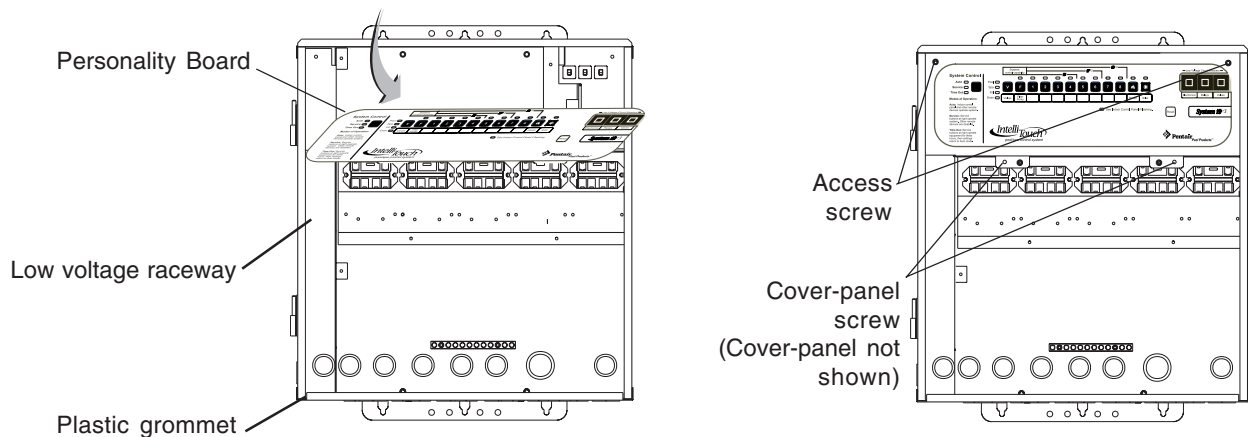

IntelliTouch Load Center

Connecting IntelliFlo to IntelliTouch (Continued)

- Strip back the cable conductors 1/4". Insert the wires into the either of the **COM PORTS (J7 and J8)** screw terminals located on the left side of the Personality board. Secure the wires with the screws. For wiring details, refer to the pin configuration shown below. *Note: Multiple wires may be inserted into a single screw terminal.*

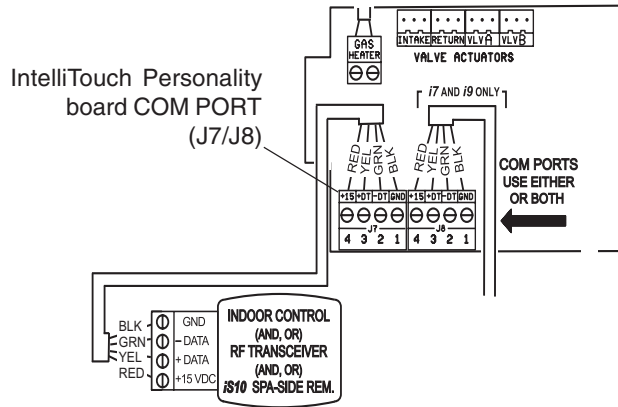

Pin Configuration for IntelliFlo to IntelliTouch:

- IntelliFlo: Connect pin 6 (green) to IntelliTouch screw terminal pin 2 (green)
- IntelliFlo: Connect pin 7 (yellow) to IntelliTouch screw terminal pin 3 (yellow)

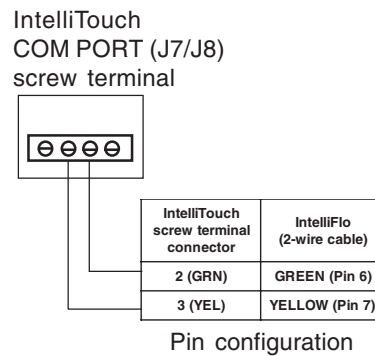
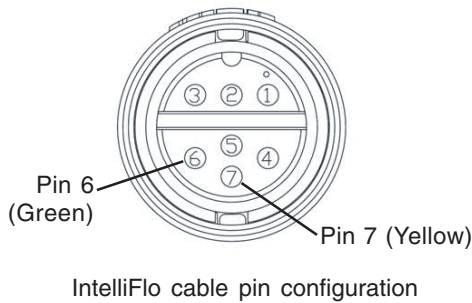

- Close the IntelliTouch control panel and secure it with the two access screws.
- Install the high voltage panel cover and secure it with the two retaining screws.
- Close the load center front door and secure with the two latches.
- Switch power on to the IntelliTouch load center.

Backwash Mode

When the Filter mode has detected that the differential pressure is at the “Clean Filter Pressure” the filter must be cleaned. You need to stop IntelliFlo either by pressing the Backwash button or “Start/Stop” button. IntelliFlo must now be run for a preset cycle time with a preset flow. The flow is adjustable to accommodate the specific filter backwash flow requirement. After the backwash cycle, a rinse cycle, with preset duration time will be executed. When the two cycles have been completed or if the Start/Stop button is pressed to stop the process, the filter status will be recalculated and the zero-pressure measured when Filter mode is operated again.

- Backwash is an essential mode for cleaning as well as maintaining the % Clean Filter menu
- Backwash mode tells the computer to recalculate the clean filter pressure and start a new cycle
- Backwash button doubles for Rinse in operation
- When using cartridge filters the backwash cycle must be performed when cleaning or replacing filters. This helps the computer reset its 0 head pressure level
- If you are charging a DE system, charge the system first during a normal running cycle. After the filter is charged, run the pump in backwash mode with the filter valve in the filter position to reset the % clean filter status. Then run the pump in filter mode.

Note: IntelliFlo will ramp up to full speed if necessary to achieve the commanded flow. Be sure that the system can withstand the resultant pressures.

Backwash menu

To access the Backwash menu:

1. Ensure that the green power LED is on and the pump is stopped.
2. Press the **Menu** button. Press the **Up** or **Down** arrows to select the “Backwash” menu.
3. **To set the backwash flow parameter:** Press the **Select** button, the “Backwash Flow” parameter is displayed. To edit the backwash flow parameter, see step 6. This parameter can be set from 15 GPM to 130 GPM. The default setting is 60 GPM. This parameter sets the preset flow for both backwash and rinse modes.
4. **To set the backwash cycle time parameter:** Press the **Up** or **Down** arrows to select the “Backwash Duration” menu. To edit this setting, see step 6. This parameter can be set from 1 to 60 minutes. The default setting is 5 minutes. This setting is the cycle time for the backwash mode.
5. **To set the backwash rinse time parameter:** Press the **Up** or **Down** arrows to select the “Rinse Duration” menu. To edit this setting, see step 6. This parameter can be set from 1 to 60 minutes. The default setting is 1 minutes. This setting is the cycle time for the rinse mode.
6. To change the value, press the **Left** and **Right** arrows to select which digit to modify, then use the **Up** and **Down** arrows to change the selected digit.
7. When you are done, press the **Enter** button to save the changes. To cancel any changes, press the **Escape** button to exit edit mode without saving.

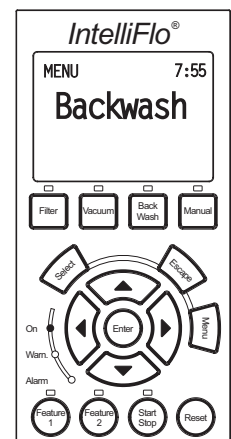

Running Backwash mode

To start Backwash mode:

1. Press the **Backwash** button.
2. When running in Backwash mode IntelliFlo will run at the preset backwash flow for the preset backwash time.
3. When the Backwash mode is stopped, manually or after the preset Backwash cycle time, the IntelliFlo will stop and show the “Rinse” menu option.
4. Press the **Start Stop** button after repositioning the backwash valve to rinse the filter.
5. When running in Rinse mode, the IntelliFlo will run at the preset backwash flow for the preset rinse time.
6. Once the pump has run in both Backwash and Rinse modes, the filter status will be recalculated in filter mode.
7. After completing Backwash and Rinse, the backwash valve should be placed into the filter position, unless other service is required.

Backwash menu screens

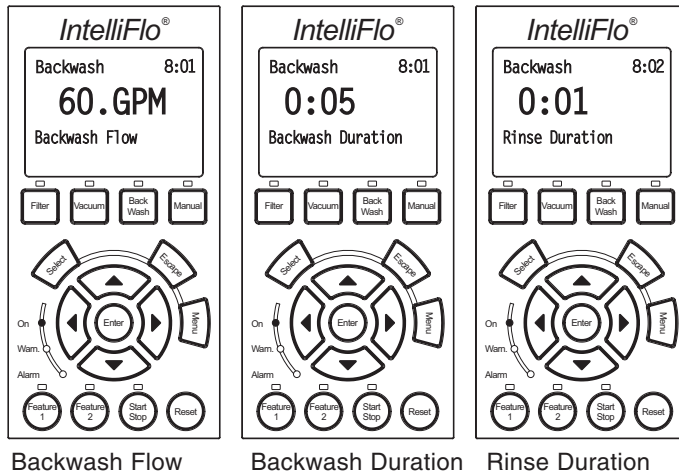

Vacuum Mode

Use Vacuum mode to clean the pool manually. Vacuum mode only operates in flow control. Vacuum mode shuts off all sensors. This mode is identical to Feature 1 and 2 except that you can manually start this mode using the Vacuum button. Safety considerations should be made when setting the Vacuum flow parameter.

CAUTION: *Since vacuuming is manual work and the user will be at the pool, the “Blocked System” will be switched off, it is important not to use any kind of automatic cleaners, (such as Kreepy Krauly, etc.) with Vacuum mode.*

Vacuum menu

To access the Vacuum menu:

1. Ensure that the green power LED is on and the pump is stopped.
2. Press the **Menu** button. Press the **Up** or **Down** arrows to select the “Vacuum” menu.
3. **To set the vacuum flow parameter:** Press the **Select** button, the “Vacuum Flow” parameter is displayed. To edit the vacuum preset flow parameter, see step 5.

This parameter can be set from 15 GPM to 130 GPM. The default setting is 50 GPM.

4. **To set the vacuum duration parameter:** Press the **Up** or **Down** arrows to select the “Vacuum Duration” menu. To edit this setting, see step 5.

This parameter can be set from 1 to 600 minutes. The default setting is 10 minutes. This setting is the amount of time you wish to run vacuum mode.

5. To change the value, press the **Left** and **Right** arrows to select which digit to modify, then use the **Up** and **Down** arrows to change the selected digit.
6. When you are done, press the **Enter** button to save the changes. To cancel any changes, press the **Escape** button to exit edit mode without saving.

To start Vacuum mode:

1. Press the **Vacuum** button to start the vacuum mode and to run at the preset vacuum flow for the preset vacuum cycle time.
2. After the preset cycle time, IntelliFlo will stop.

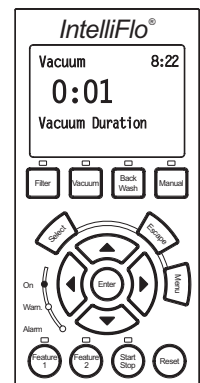
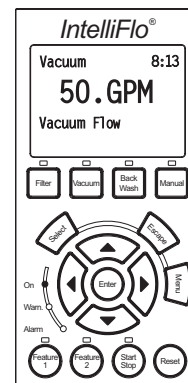
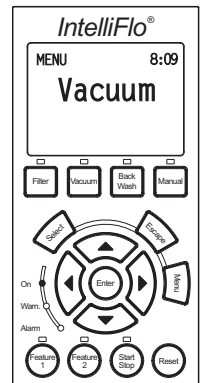

Vacuum Flow and Duration

Blank Page

Section 4

User Maintenance

The following information describes how to service and maintain the IntelliFlo pump.

Pump Strainer Basket

The strainer, sometimes referred to as the “Hair and Lint Pot,” is in front of the of the pump. Inside there is a basket which must be kept clean of leaves and debris at all times. View the basket through the top see through lid to inspect for leaves and debris.

Regardless of the length of time between filter cleaning, it is most important to visually inspect the hair and lint pot basket at least once a week. A dirty basket will reduce the efficiency of the filter and possibly the heater.

 **WARNING** — **DO NOT** open the strainer pot if pump fails to prime or if pump has been operating without water in the strainer pot. Pumps operated in these circumstances may experience a build up of vapor pressure and may contain scalding hot water. Opening the pump may cause serious personal injury. In order to avoid the possibility of personal injury, make sure the suction and discharge valves are open and that the strainer pot is cool to the touch, then open with extreme caution.

 **CAUTION** — To prevent damage to the pump and filter and for proper operation of the system, clean pump strainer and skimmer baskets regularly.

Pump Strainer Basket Service

If the IntelliFlo pump is installed below the water level of the pool, close the return and suction lines before opening the hair and lint pot on the pump.

1. Place the IntelliFlo in “Manual” mode. Press the Start/Stop button to stop the pump and switch off the pump at the circuit breaker.
2. Disconnect the communication cable from the IntelliFlo pump.
3. Relieve pressure in the system.
4. Turn the clamp and lid in a counterclockwise direction until it stops.
5. Remove the clamp and lid.
6. Remove the basket and put the debris into the trash and rinse out the basket. If the basket is cracked, replace the basket.
7. Replace the basket and fill the pump pot and volute with water up to the inlet port.
8. Clean the cover, O-ring, and sealing surface of the pump pot. Grease the O-ring with Teflon or silicone lubricant.
9. Reinstall the lid by placing the clamp and the lid on the pot.

Pump Strainer Basket Service (Continued)

10. Ensure that the lid o-ring is properly placed. Seat the clamp and lid then turn clockwise until the handles are horizontal as shown.
11. Reconnect the communication cable to the pump if required.
12. Switch the power ON at the circuit breaker. Reset the pool time clock to the correct time.



WARNING - FILTER OPERATES UNDER HIGH PRESSURE. WHEN ANY PART OF THE CIRCULATING SYSTEM (e.g., LOCK RING, PUMP, FILTER, VALVES, ETC.) IS SERVICED, AIR CAN ENTER THE SYSTEM AND BECOME PRESSURIZED. PRESSURIZED AIR CAN CAUSE THE LID TO BLOW OFF WHICH CAN RESULT IN SEVERE INJURY, DEATH, OR PROPERTY DAMAGE. TO AVOID THIS POTENTIAL HAZARD, FOLLOW THESE INSTRUCTIONS.

13. Open the manual air relief valve on top of the filter.
14. Stand clear of the filter. Press the Start button on the pump.
15. Bleed air from the filter until a steady stream of water comes out.
16. Close the manual air relief valve.

Motor Service

1. **Protect from heat:**
 - Shade the motor and controller from the sun.
 - Any enclosure must be well ventilated to prevent overheating. Particular attention should be paid to the motor fan cover and the cooling fins between the drive and the motor.
 - Provide ample cross ventilation.
2. **Protect against dirt:**
 - Protect from any foreign matter or splashing water.
 - Do not store (or spill) pool chemicals near the motor.
 - Avoid sweeping or stirring up dust near the motor while it is operating.
 - If a motor has been damaged by dirt it voids the motor warranty.
3. **Protect against moisture:**
 - Protect from splashing pool water.
 - Protect from the weather.
 - Protect from lawn sprinklers.
 - If a motor has become wet - let it dry before operating. Do not allow the pump to operate if it has been flooded.
 - If a motor has been damaged by water it voids the motor warranty.

Note: DO NOT wrap motor and controller with plastic or other air tight materials. The motor and controller may be covered, but not wrapped in plastic, during a storm, for winter storage, etc., but never when operating, or expecting operation.

When replacing the motor, be certain that the motor support is correctly positioned to support the size of motor being installed.

Winterizing

The IntelliFlo's internal anti-freeze protection is disabled when connected to an IntelliTouch. Freeze protection is provided by selecting YES at the ON WITH FREEZE portion of the IntelliTouch's appropriate circuit function menu. To re-enable the IntelliFlo's internal anti-freeze protection, the power to the drive must be cycled off then back on.

1. If the air temperature drops below 35° F the water in the pump can freeze and cause damage. Freeze damage is not warrantable.
2. To prevent freeze damage follow the procedures listed below.
 - Shut off electrical power for the pump at the circuit breaker.
 - Drain the water out of the pump by removing the two thumb-twist drain plugs located at the bottom of the volute. Store the plugs in the pump basket.
 - Cover the motor to protect it from severe rain, snow and ice.
 - Do not wrap the motor in plastic. It will cause condensation and rust on the inside of the motor.

Note: In mild climate areas, when temporary freezing conditions may occur, run your filtering equipment all night to prevent freezing.

Manual Priming and Initial Start-up After Service

Before a system start-up, the pump and system must be manually primed. Make sure to reopen valves before operating. To prime IntelliFlo, the strainer pot must be filled with water.

 **CAUTION** — DO NOT run the pump dry. If the pump is run dry, the mechanical seal will be damaged and the pump will start leaking. If this occurs, the damaged seal must be replaced. ALWAYS maintain proper water level in your pool. Continued operation in this manner could cause a loss of pressure, resulting in damage to the pump case, impeller and seal.

To prime the IntelliFlo pump:

1. Turn the pump clamp and lid in a counterclockwise direction until it stops and remove them.
2. Fill the pump strainer pot with water.
3. Reinstall the pump clamp and lid onto the strainer pot. The pump is now ready to prime.

4. Make sure all electrical connections are clean and tight.
5. Open the air release valve on the filter, and stand clear of the filter.
6. Switch the IntelliFlo on at the circuit breaker. Ensure that the green power LED is on.
7. Press the **Manual** button (LED on) to place IntelliFlo in manual mode.
8. Use the **Up** and **Down** arrows to select **Set Speed**, then press the **Select** button to edit the setting.
7. Adjust speed as necessary. Press the **Left** and **Right** arrows to select which digit to modify, then use the **Up** and **Down** arrows to change the speed. Press the **Enter** button to save the changes. To cancel any changes, press the **Escape** button to exit edit mode without saving.
9. Press the **Start/Stop** button to start the pump.
10. When water comes out of the air release valve, close the valve. The system should now be circulating water back to the pool without air bubbles showing in either the hair and lint pot or at the pool return fittings.

Section 5

Installation and Removal

The following general information describes how to install the IntelliFlo VF pump.

Attention Installer: Before installing the IntelliFlo pump, read and follow all warning notices, instructions and safety precautions on pages iii and vi.

Installing the IntelliFlo VF

Only a qualified service person should install the IntelliFlo.

Location

1. Install the pump as close to the pool or spa as possible. To reduce friction loss and improve efficiency, use short and direct suction and piping returns.
2. Install a minimum of five (5) feet from the inside wall of the pool and spa. Canadian installations require a minimum of three (3) meters from pool water.
3. Install the pump a minimum of two (2) feet from the heater inlet.
4. Do not install the pump more than (8) feet above the water level.
5. Install the pump in a sheltered well ventilated location protected from excessive moisture, (i.e., rain, sprinklers, etc.).
6. For hot tubs and spas, do not install within an outer enclosure or beneath the skirt of a hot tub or spa.
7. Install the pump with a rear clearance of at least 6 inches so that the motor can be removed easily for maintenance and repair.

Piping

For improved pool plumbing, it is recommended to use a larger pipe size. When installing the inlet and outlet fittings (male adaptors), use thread sealant. **Do NOT use Teflon® tape.**

Do not install 90° elbows directly into pump inlet or outlet. A valve, elbow or tee installed in the suction line should be no closer to the front of the pump than five (5) times the suction line pipe diameter (i.e., two (2) inch pipe requires a ten (10) inch straight run in front of the suction inlet of the pump). This will help the pump prime faster and last longer.

Flooded suction systems should have gate valves installed on suction and discharge pipes for maintenance, however, the suction gate valve should be no closer than five (5) times the suction pipe diameter as described above.

Check Valves

Check valves must be used when an IntelliFlo is used in parallel with other pumps. IntelliFlo pumps cannot be connected in series with other pumps.

Wiring the IntelliFlo VF



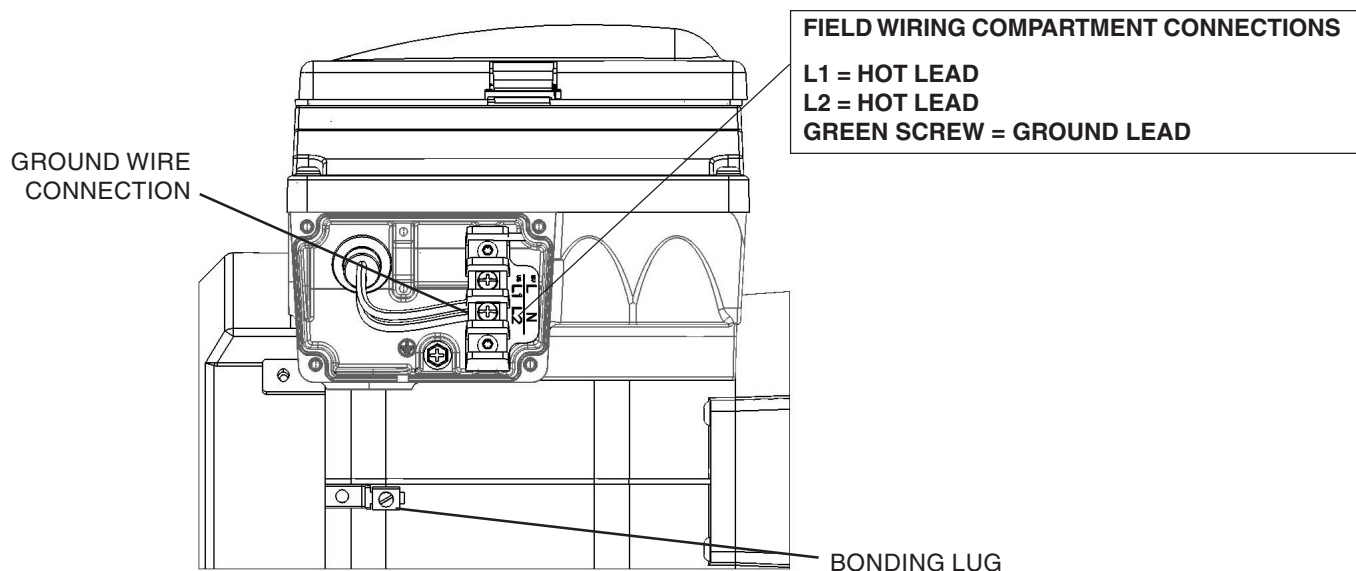

To connect the IntelliFlo to AC power:

1. Make sure all electrical breakers and switches are turned off before wiring motor.
2. Make sure that the wiring voltage is 230 VAC.
3. Use #12 AWG for wire runs up to 100 feet and #10 AWG for lengths longer than 100 feet. When in doubt use a heavier gauge (larger diameter) wire. Heavier gauge will allow the motor to run cooler and more efficient.
4. Make sure all electrical connections are clean and tight.
5. Cut the wires to the appropriate length so they do not overlap or touch when connected.
6. Permanently ground the motor using the green ground wire, as shown below. Use the correct wire size and type specified by National Electrical Code. Make sure the ground wire is connected to an electrical service ground.
7. Bond the motor to the pool structure in accordance with the National Electrical Code. Use a solid No. 8 AWG or larger copper conductor (No. 6 or larger in Canada). Run a wire from the external bonding lug to the pool bonding structure, as shown below.
8. The pump should be permanently connected to either a **circuit breaker, 2-pole timer or 2-pole relay**. If AC power is supplied by a GFCI circuit breaker, use a dedicated circuit breaker that has no other electrical loads.
9. **IMPORTANT: When connecting the pump to an automation system (IntelliTouch, EasyTouch®, SunTouch® and IntelliComm), continuous power must be supplied to the pump by connecting it directly to the circuit breaker. When using an automation system, Be sure that no other lights or appliances are on the same circuit.**

NOTE: When the IntelliFlo VS is started and stopped by removing power with a relay or timer, a two-pole device should be used to apply and remove power to both POWER LINE TERMINALS.



Pump Disassembly

-  **WARNING** — Always disconnect power to the pool pump at the circuit breaker before servicing the pump. Failure to do so could result in death or serious injury to serviceman, pool users or others due to electric shock.
-  Read all servicing instructions before working on the pump.
-  **WARNING** — **DO NOT** open the strainer pot if pump fails to prime or if pump has been operating without water in the strainer pot. Pumps operated in these circumstances may experience a build up of vapor pressure and may contain scalding hot water. Opening the pump may cause serious personal injury. In order to avoid the possibility of personal injury, make sure the suction and discharge valves are open and strainer pot temperature is cool to touch, then open with extreme caution.
-  **CAUTION** — Be sure not to scratch or mar the polished shaft seal faces; seal will leak if faces are damaged.

All moving parts are located in the rear sub-assembly of the IntelliFlo pump.

Tools required:

- 3/32 inch Allen head wrench.
- ½ inch open end wrench.
- 9/16 inch open end wrench.
- Flat blade screwdriver.

To remove and repair the pump mechanical seal, perform the following procedures:

1. Switch off the pump circuit breaker at the main panel.
2. Disconnect the communication cable from the pump.
3. Drain the pump by removing the drain plugs.
4. Remove the six bolts that hold the main pump body (strainer pot/volute) to the rear sub-assembly.
5. GENTLY pull the two pump halves apart, removing the rear sub-assembly.
6. Use a 3/32 inch Allen head wrench to loosen the two holding screws located on the diffuser.
7. Hold the impeller securely in place and remove the impeller lock screw by using a Phillips head screwdriver. The screw is a left-handed thread and loosens in a clockwise direction.
8. Use a flat blade screwdriver to hold the motor shaft. The motor shaft has a slot on the end which is accessible through the center of the fan cover.

Pump Disassembly (Continued)

9. To unscrew the impeller from the shaft, twist the impeller counterclockwise.
10. Remove the rotating portion of the mechanical seal from the impeller.
11. Remove the four bolts from the seal plate to the motor, using a 9/16 inch wrench.
12. Place the seal plate face down on a flat surface and tap out the carbon spring seat.
13. Clean the seal plate, seal housing, and the motor shaft.

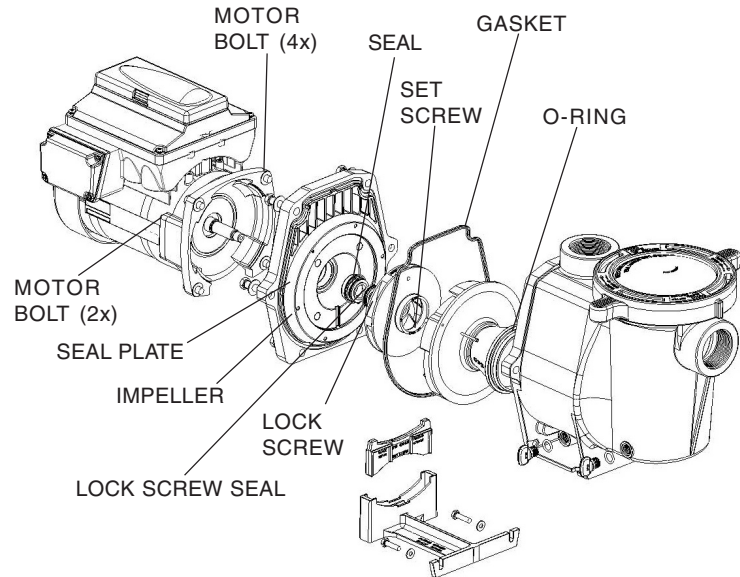

Pump Reassembly/Seal Replacement

1. When installing the replacement shaft seal, use silicone sealant on the metal portion before pressing into the seal plate as shown above.
2. Before installing the rotating portion of the seal into the impeller, be sure the impeller is clean. Use a light density soap and water to lubricate the inside of the seal. Press the seal into the impeller with your thumbs and wipe off the ceramic and carbon faces with a clean cloth.
3. Remount the seal plate to the motor.
4. Grease the motor shaft thread and screw impeller onto the motor shaft.
5. Screw in the impeller lock screw (counterclockwise to tighten).
6. Remount the diffuser onto the seal plate. Make sure the plastic pins and holding screw inserts are aligned.
7. Grease the diffuser O-ring and seal plate gasket prior to reassembly.
8. Grease the bolt threads, assemble the motor sub-assembly to the strainer pot-pump body by using the two (2) through bolts for proper alignment. Do not tighten the through bolts until all six (6) bolts are in place and fingertightened.
9. Fill the pump with water.
10. Reinstall the pump lid and plastic clamp then reprime the system, see page 39.

Shaft Seal Replacement

The Shaft Seal consists primarily of two parts, a rotating member and a ceramic seal. The pump requires little or no service other than reasonable care, however, a Shaft Seal may occasionally become damaged and must be replaced.

Note: The polished and lapped faces of the seal could be damaged if not handled with care.

Drive Assembly Removal and Installation

To remove the IntelliFlo VF drive and control panel from the motor assembly:

1. Make sure all electrical breakers and switches are turned off before removing the drive.
2. Disconnect the communication cable from the pump.
3. Open the control panel cover.
4. Remove the three Phillips head screws securing the drive to the motor assembly as shown.

CAUTION: TO AVOID ELECTRICAL HAZARD, DO NOT REMOVE THE TAMPER PROOF SCREWS (QTY 4) FROM THE MOTOR ASSEMBLY

5. Lift up the drive assembly and remove it from the motor adapter located on top of the motor assembly.

Note: Be careful not to remove the gasket between the drive and motor, it is critical in keeping moisture out of the drive and motor. Replace the gasket if damaged. Do not reassemble with a damaged or missing gasket.

To install the IntelliFlo drive assembly onto the motor assembly:

1. Make sure all electrical breakers and switches are turned off before removing the drive.
2. Ensure that the gasket between the drive and motor is in place. It is critical in keeping moisture out of the drive and motor. Replace the gasket if damaged. Do not reassemble with a damaged or missing gasket.
3. Align the drive assembly with the motor adapter and seat the drive on the motor assembly.
4. Secure and tighten the drive assembly with the three Phillips head screws.

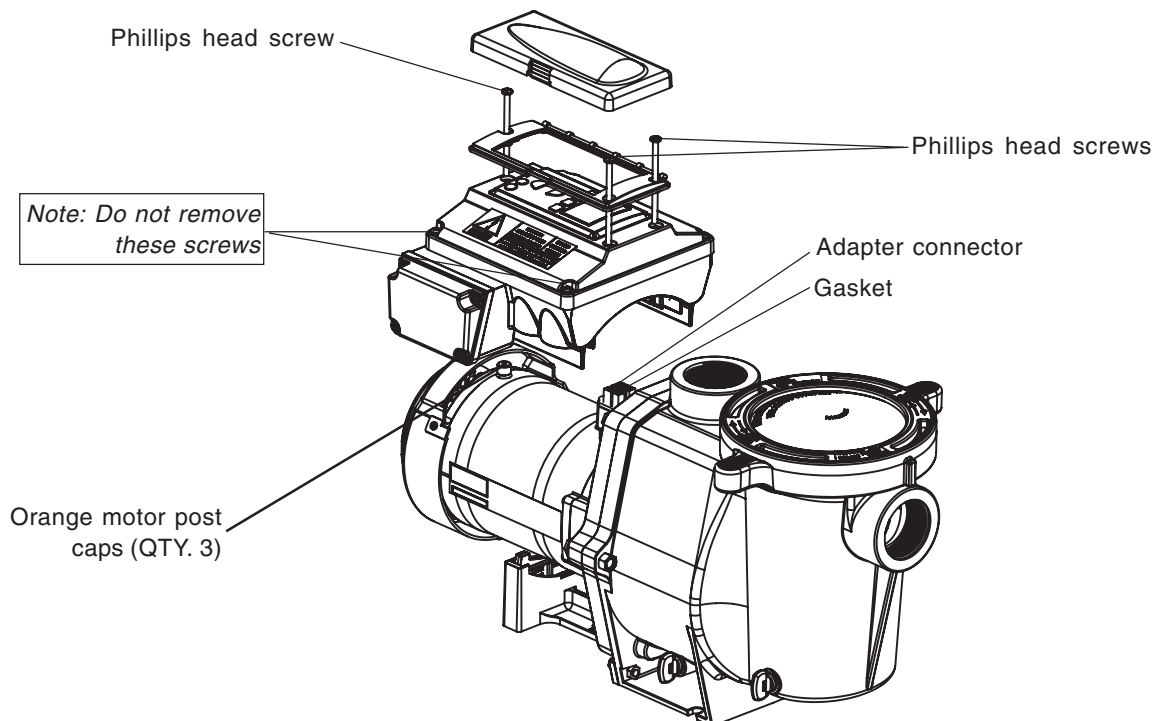

Illustrated Parts List

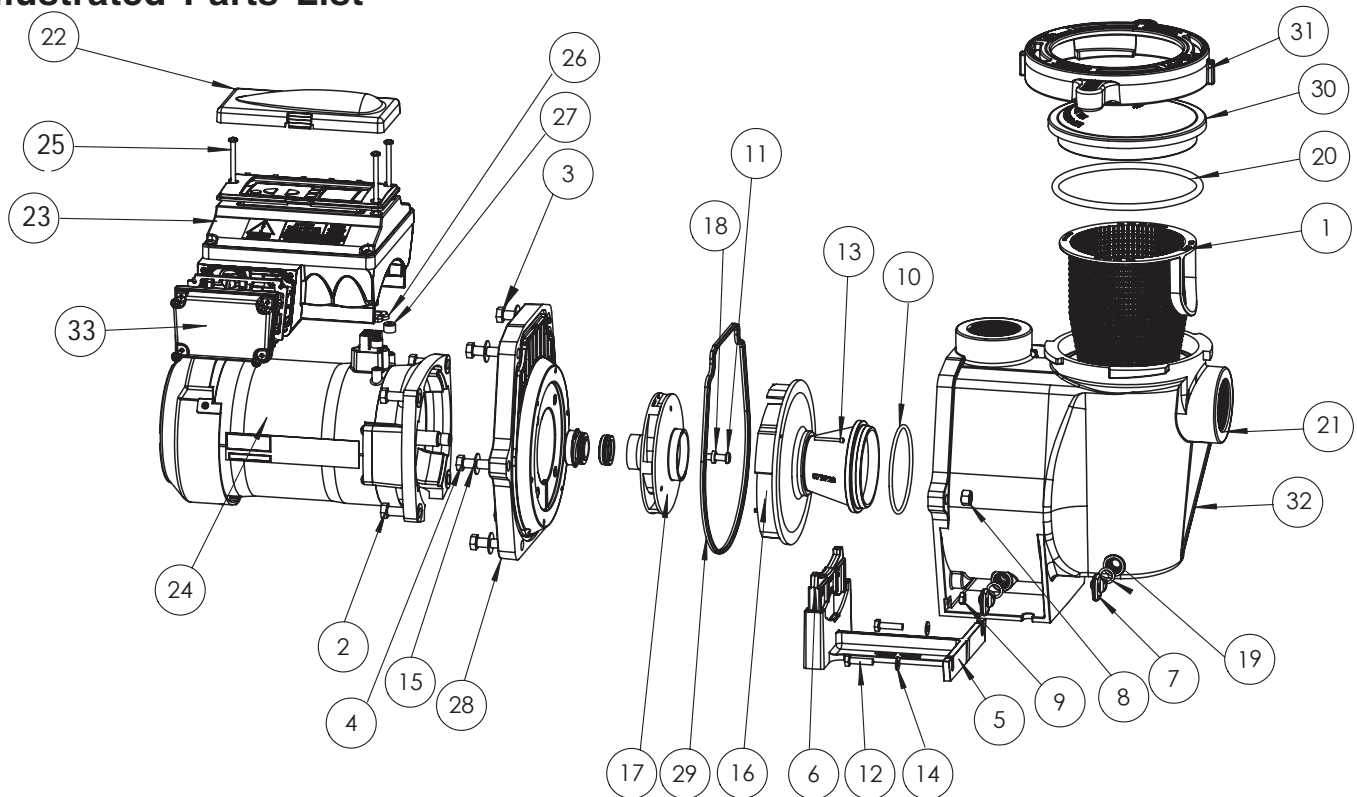

Replacement Parts

Item No.	Part No.	Description
1	070387	BASKET AQ & WF
2	070429	BOLT HEX HD, 2-56x0.875 s/s, (QTY 4)
3	070430	BOLT 3/8 - 16 X 1 1/4 HEX CAP 18-8 s/s, (QTY 4)
4	070431	BOLT 3/8 - 16 X 2 HEX CAP 18-8 s/s, (QTY 2)
5	070927	FOOT WF - PUMP MOTOR SUPPORT
6	070929	FOOT INSERT WF PUMP
7	071131	PLUG DRAIN WFE (Almond) (QTY 2)
8	071403	NUT 3/8 - 16 BRASS NICKEL PLATED, (QTY 2)
9	071406	NUT 1/4 - 20 HEX s/s (QTY 2)
10	071444	O-RING 238, 3.484x0.139, Buna-N 70
11	071652	SCREW 1/4-20 X 1 LH PHILLIPS PAN MS 18-8 s/s
12	071657	SCREW 1/4 - 20 X 1 in. HEX CAP 18-8 s/s, (QTY 3)
13	071660	SCREW SET 4-40 X 1-1/8 WFE SCKT CAP 18-8 s/s (QTY 2)
14	072183	WASHER FLAT 1/4 X 5/8 20 GA THICK 18-8 s/s (QTY 2)

Item No.	Part No.	Description
15	072184	WASHER 3/8 ID X 7/8 OD .05 THICK 18-8 s/s, (QTY 6)
16	072928	DIFFUSERASSEMBLY WFE 12
17	073131	IMPELLER WFE 12 1000 SER
18	075713	RUBBER WASHER WFE PUMP
19	192115	O-RING 112, 0.487x0.103 Buna-N 70 (QTY 2)
20	350013	O-RING LID CH/WF 2-436
21	350015	HOUSING WFE (Almond)
22*	350082	CONTROL COVERASSEMBLY
23*	350104	INTELLIFLO VAR-SPD MTR DRV 3.2KW
24*	350105	VFD MOTOR 3.2 KW PMSM
25	350107	SCREW 10-24 X 3 1/4 in. PH MS 18-8 s/s, (QTY 3)
26	350108	INTELLIFLO DRIVE GASKET
27	350142	SPACER CAP (QTY 3)
28	350201	SEAL PLATE KIT, WFE ALMOND
29	357100	GASKET SANTOPRENE MOLDED
30	357151	LID SEE THRU WF
31	357199	CLAMP CAM & RAMP WF (Almond)
32	357243	POT WF ASSY (Almond)
33	350621	Cover Assembly, FWC

Note: (*) Not serviceable parts.

IntelliFlo VF Pump Dimensions

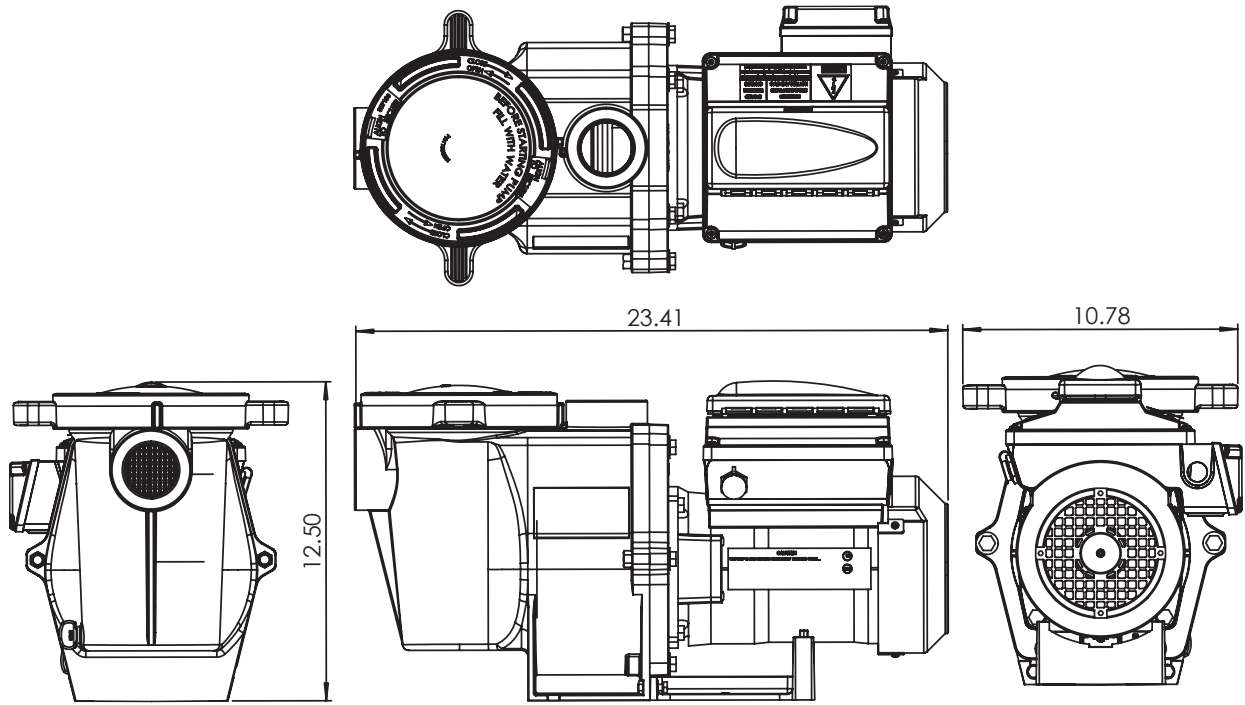

Intelliflo VF Flow and Power vs Flow Pump Curve

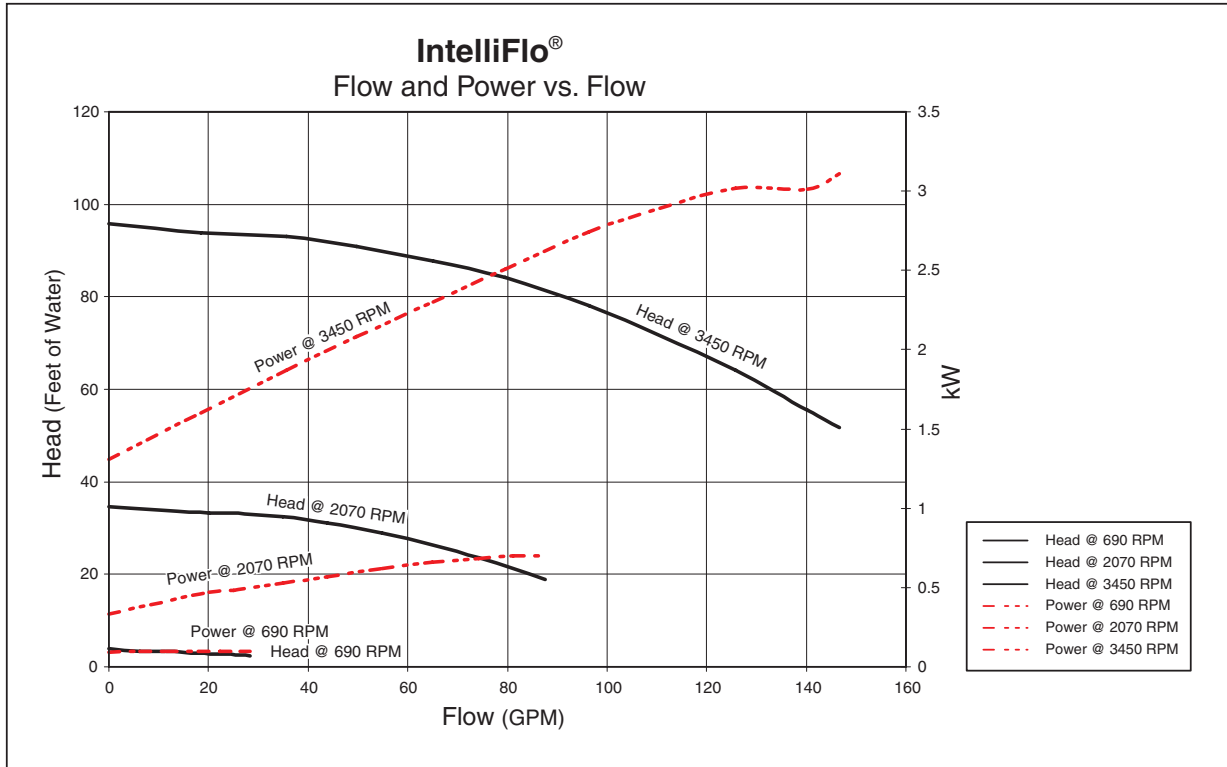

IntelliFlo VF Electrical Specifications

Circuit Protection: Two-pole 20 AMP device at the Electrical Panel.

Input: 230 VAC, 50/60 Hz, 3200 Watts

Blank Page

Section 6

Troubleshooting

IMPORTANT: Before troubleshooting the IntelliFlo pump, read and follow all warning notices, instructions and safety precautions on pages iii and vi.

Alerts and Warnings

The IntelliFlo VF displays all alarms and warnings on the control panel display. When an alarm or warning condition exists, the corresponding LED will be lit on the display. All control panel buttons are disabled until the alarm or warning is acknowledged with the **Enter** button. Press the **Reset** button to clear the alarm once the fault condition has been resolved. Note: The IntelliFlo pump will not start if the impeller is rotating. The alerts and warnings are:

- **Power out failure:** The incoming supply voltage is less than 170 VAC. The drive faults to protect itself from over current. The drive contains capacitors that keep it powered up long enough to save the current run parameters. If power is restored during this process, approximately 20 seconds, the drive will not restart until completed.
- **Priming error:** If the pump is not defined as primed within the "Max Priming Time" it will stop and generate a "Priming Alarm" for 10 minutes, then attempt to prime again. The "Max Priming Time" is set by the user on the priming menu as discussed on page 14. If the IntelliFlo cannot prime within five attempts it will generate a permanent alarm that must be manually reset.
- **Overheat alert:** If the drive temperature gets above 130 degrees, the IntelliFlo will slowly reduce speed until the over temperature condition clears.
- **Anti-freezing:** When active, the motor will run at 1000 rpm for 60 minutes. Only active in Filter and Manual modes. Note: The IntelliFlo's internal anti-freeze protection is disabled when connected to an IntelliTouch system. Freeze protection is provided by selecting YES at the ON WITH FREEZE portion of the IntelliTouch's appropriate circuit function menu. To re-enable the IntelliFlo's internal anti-freeze protection, the power to the drive must be cycled off then back on.
- **Blocked system:** Detects a blocked suction line. This alarm resets automatically after 30 seconds and the pump restarts.
- **System service soon:** Alerts the operator that the pump discharge pressure has reached the Clean Filter Pressure as setup in the Filter Menu. The filter status will be displayed as 100%. The yellow warning LED will be on until a backwash cycle is operated. The IntelliFlo will automatically reduce speed as necessary to not exceed the Clean Filter Pressure.
- **Over current:** Indicated that the drive is overloaded or the motor has an electrical problem. The drive will restart 20 seconds after the over current condition clears.
- **Over voltage:** Indicates excessive supply voltage or an external water source is causing the pump and motor to rotate thereby generating an excessive voltage on the drives internal DC bus. The drive will restart 20 seconds after the over voltage condition clears.

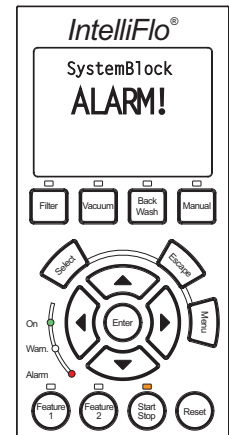

Suction Blockage

When something blocks the suction or the pump fully it will shut off immediately (within 1 second). It will also shut off after a few seconds of dead heading with the same alert. The unit will come back on in 30 seconds and ramp up slowly. This function should be tested with all new installations by directing the flow to one suction and covering it with a piece of material other than someone's hand. This alert is deactivated in Manual mode.

General IntelliFlo Troubleshooting Problems

Use the following general troubleshooting information to resolve possible problems with your IntelliFlo pump.

Note: Turn off power to unit prior to attempting service or repair.

Problem	Possible Cause	Corrective Action
<p>Pump failure. (For IntelliFlo alert display messages, refer to Alerts and Warning on page 49).</p>	<p>Pump will not prime - Air leak in suction.</p> <p>Pump will not prime - Not enough water.</p> <p>Pump strainer clogged.</p> <p>Pump strainer gasket defective.</p>	<p>Check suction piping and valve glands on any suction gate valves.</p> <p>Secure lid on pump strainer pot and make sure lid gasket is in place.</p> <p>Check water level to make sure skimmer is not drawing air.</p> <p>Ensure that the suction lines, pump, strainer, and pump volute are full of water.</p> <p>Clean pump strainer pot.</p> <p>Replace gasket.</p>
<p>Reduced capacity and /or head. (For IntelliFlo alert display messages, refer to Alerts and Warning on page 49).</p>	<p>Air pockets or leaks in suction line.</p> <p>Clogged impeller.</p> <p>Pump strainer clogged.</p>	<p>Check suction piping and valve glands on any suction gate valves.</p> <p>Turn off electrical power to the pump.</p> <p>Remove the (6) bolts that holds the volute to the seal plate.</p> <p>Slide the motor and seal plate away from the volute.</p> <p>Clean debris from impeller. If debris cannot be removed, complete the following steps.</p> <ol style="list-style-type: none"> 1. Remove diffuser and O-ring. 2. Remove left hand thread anti-spin bolt and O-ring. 3. Remove, clean and reinstall impeller. 4. Reinstall anti-spin bolt and O-ring. <p>Reinstall diffuser, and O-ring.</p> <p>Reinstall motor and seal plate into volute.</p> <p>Reinstall (6) bolts around seal plate and volute and tighten securely.</p> <p>Clean suction trap.</p>

Problems and Corrective Action (Continued)

Problem	Possible Cause	Corrective Action
Inadequate circulation. (For IntelliFlo alert display messages, refer to Alerts and Warning on page 49).	Pump overcurrent.	Check trap basket; if plugged, turn pump off and clean basket. Suction/discharge piping is too small. Check and clean pool filter.
Circuit breaker trips repeatedly. (For IntelliFlo alert display messages, refer to Alerts and Warning on page 49).	Excessive motor current. GFCI fault.	Breaker must be of adequate capacity. For GFCI breaker, test according to GFCI manufacturer's instructions. Be sure no other lights and appliances are on circuit. Voltage too high or too low.
Electrical problem. (For IntelliFlo alert display messages, refer to Alerts and Warning on page 49).	Pump may be running too slowly. Pump may be too hot.	Check voltage at motor terminals and at meter while pump is running. If low, see wiring instructions or consult power company. Check for loose connections. Check line voltage; if less than 90% or more than 110% of rated voltage consult a licensed electrician. Increase ventilation. Reduce ambient temperature. Tighten any loose wiring connections. Motor internal terminal overload protector is open. Motor runs too hot. Turn power to motor off. Check for proper voltage. Check for proper impeller or impeller rubbing.
Mechanical Troubles and Noise.	The pump motor is running but with loud noise. Cavitation.	If suction and discharge piping are not adequately supported, pump assembly will be strained. Do not mount pump on a wooden platform! Securely mount on concrete platform for quietest performance. Foreign matter (gravel, metal, etc.) in pump impeller. Disassemble pump, clean impeller, follow pump service instructions for reassembly. Improve suction conditions. Increase pipe size. Decrease number of fittings. Increase discharge pressure.
IntelliFlo does not respond to IntelliTouch commands	Improper IntelliTouch/IntelliFlo setup. Communication network inoperative.	1. Ensure that the communication cable is connected at both ends. 2. Check that the IntelliFlo local address matches with the address used in the IntelliTouch. 3. Check that the IntelliFlo has been assigned a circuit name on the IntelliTouch. 4. Ensure that the IntelliFlo display says "DISPLAY NOT ACTIVE". A defective device on the network can inhibit the proper operation of other network device. Devices should be disconnected sequentially until the network starts working.

General Warnings

- Never go inside the drive enclosure. There is a capacitor bank that holds a 230 VAC charge even when there is no power to the unit.
- IntelliFlo is not submersible
- The pump is capable of 160 GPM or 104 feet of head; use caution when installing and programming to limit pumps performance potential with old or questionable equipment
- Code requirements for the electrical connection differ from state to state. Install equipment in accordance with the National Electrical Code and all applicable local codes and ordinances.
- There is no pressure limit in “Features” flow control
- Manual mode shuts off all sensors including Suction Blockage; use only in emergency or when metering a system.
- The unit needs constant power it is built to turn itself on / off
- Always stop the unit before performing maintenance

Electrical Cost Overview

To calculate a system’s “Continuous Watts” use the following formula:

Amps X Volts X Power Factor = Continuous Watts

Examples:

- 1 HP E+ WhisperFlo = 7.4 amps X (230 Volt) X .90 PF = 1532 watts
- 1 HP Max – E – Pro = 8.0 amps X (230 Volt) X .87 PF = 1600 watts

Once watts are computed, convert watts to kilowatts (kilo is 1000) and multiply this number by kilowatt/hour cost.

1 watt = .01 Kilowatt

100 watts = .1 Kilowatt

1000 watts = 1 Kilowatt

1 HP E+ WhisperFlo 1532 watts or 1.532 Kilowatt x \$.08 = \$.122 per hour

1 HP Max-E-Pro 1600 watts or 1.600 Kilowatt x \$.08 = \$.128 per hour

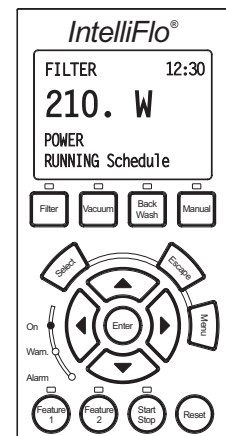

The IntelliFlo does not require calculation for continuous watts since it is displayed on the screen in all modes. Just simply take the watts published on the screen, convert to kilowatts, and multiply by the kilowatt hour. The formula is:

210 watts = .210 kilowatt X \$.08 = \$.016 per hour

Remember to also consider the amount of water moved for the cost incurred (Water to Wire Efficiency). The IntelliFlo cannot be matched in today’s industry for flow versus continuous watts at any speed by any other pump in pool. The Filter mode and flow control further assists in cost saving by always allowing the pump to do the least amount of work at all times.

How to make your pool more energy efficient

Swimming pools are great for relaxing, exercising or just having fun. But they also mean higher than average energy bills. The key to saving energy with your pool is to correctly manage the filter pump time, pool temperature and lighting. Consider the following when operating your swimming pool:

Using your IntelliFlo VF pump

Your pool needs to be filtered every 24 hours. The time to filter the pool depends on:

- The size of your pool.
- The filtering equipment.
- How much you use your pool.
- Different environmental factors (such as how much sunlight hits the pool).

Typically, one complete turnover of water every 24 hours provides adequate filtering for a single-family pool. The more you use your pool, the more filtering it will need. It is generally recommended that you run your filter for four to six hours a day during the summer and two to four hours a day during the winter. If you're filtering more than this, try reducing your daily filtering time by 30 minutes. After a week, if the water clarity and chemical balance show adequate filtration is taking place, try reducing your filtering time by another 30 minutes. Continue this process until water clarity or chemical imbalance indicates more filtering is needed. In addition to chemical testing, a good way to check your water clarity is that the main drain cover should be clearly visible from the deck.

Automatic pool sweeps (booster pump style)

Usually, three to four hours of daily operation during summer and two to three hours daily in the winter are sufficient. Start the pool sweep one hour or more after the pool pump has started and stop the sweep one hour or more before the pool pump turns off. On unusually dusty days, increase cleaning time in half-hour increments until the pool is clean. Use a wall brush and leaf skimmer frequently to help the sweep along.

Filter during off-peak times

You can help everyone by filtering your pool during off-peak hours. Avoid operating your pool filter between the hours of noon and 6 P.M. This will help reduce the demand for electricity, conserve natural resources, and save money. Of course, if your pool has solar heating, you'll need to filter when the sun is correctly positioned for your solar panels. However, we recommend that you minimize filtration during the peak period of noon to 6 P.M. as much as possible.

Setting filtering time

A filter time clock is an easy way to manage pool filtering. Just be sure to check it once a month to make sure the trippers are secure. Check your clock's instruction manual for directions on setting the operation times. Remember to reset the time clock after power outages and for the fall and spring time change.

Preventive maintenance

Follow a regular program of preventive maintenance, including an annual inspection of the heat exchanger to help maintain heating efficiency.

Energy Efficient IntelliFlo pump

When its time to replace your old motor and pump assembly, consider using the IntelliFlo variable speed energy-efficient pump. It moves more water more efficiently, and can help you reduce your filter operating time by hours. IntelliFlo can automatically control tasks like pool vacuuming, filtering and backwashing, operating the automatic pool sweep and pump operation for the pool/spa combination. Once these tasks are done, IntelliFlo automatically ramps down to low speed for your pool's daily filtration cycle, which can save energy and money for you.

Notes

Notes

SAVE THESE INSTRUCTIONS

Notes

